

---

IBM 3880 Storage Control  
Models 1, 2, 3, and 4

---

Description Manual

---

Cross-System

---

Publication Number  
GA26-1661-9

File Number  
4300-07. S370-07

---

## **Federal Communications Commission (FCC) Statement**

**Warning:** This equipment generates, uses, and can radiate radio frequency energy and if not installed and used in accordance with the instruction manual, may cause interference to radio communications. It has been tested and found to comply with the limits for a Class A computing device pursuant to Subpart J of Part 15 of FCC rules, which are designed to provide reasonable protection against such interference when operated in a commercial environment. Operation of this equipment in a residential area is likely to cause interference in which case the user at his own expense will be required to take whatever measures may be required to correct the interference.

### **| Tenth Edition (September 1987)**

| This major revision replaces and obsoletes GA26-1661-8. Changes or additions to the text and illustrations are indicated by a vertical line to the left of the change.

Periodically changes or additions may be made to the information in this manual. Before using this publication in connection with the operation of IBM systems, consult you local IBM branch office for the editions that are current and applicable.

References in this publication to IBM products, programs, or services do not imply that IBM intends to make these available in all countries where IBM operates. Any reference to an IBM program product in this publication is not intended to state or imply that only IBM's program product may be used. Any functionally equivalent program may be used instead.

Publications are not stocked at the address given below. Requests for IBM publications should be made to your IBM representative or to the IBM branch office serving your locality.

A form for readers' comments is provided at the back of this publication. If the form has been removed, comments may be addressed to IBM Corporation, General Products Division, Department 61C, Tucson, Arizona, U.S.A. 85744. IBM may use or distribute whatever information you supply in any way it believes appropriate without incurring any obligation. You may, of course, continue to use the information.

## Preface

The IBM 3880 Storage Control and its attached disk storage devices provide high-speed, direct-access storage for general purpose data storage and system residence. It attaches to the processing unit through a block multiplexer channel.

For experienced programmers, this manual provides readily accessible reference material related to channel command words, sense bytes, and error recovery.

Less experienced programmers will find sufficient information to create channel programs to best use the standard and special features of the 3880.

This manual is organized by the following topics:

- Introduction - describes the basic units and lists highlights and functions.
- Input/Output Operations - describes operations between the processing unit, channel, and storage control.
- Fixed Block Command Set - describes each command in the fixed block command set and gives examples of channel programs for reading and writing data.
- Count, Key, and Data Command Set - describes each command in the count, key, and data command set and gives examples of channel programs for formatting, reading, and writing.
- Standard and Special Features - describes all the features associated with the 3880 and gives examples of how they are used.
- Error Recovery Procedures and Sense Bytes- describes all error recovery

procedures and sense bytes for each type of device that attaches to the 3880.

- Operator Panel - describes the switches and indicators associated with the operation of the 3880.

### Prerequisite Publications

Programmers should be familiar with the information contained in the *IBM System/370 Extended Architecture Principles of Operation*, SA22-7085; *IBM System/370 Principles of Operation*, GA22-7000; and the *IBM 4300 Processors Principles of Operation for ECPS:VSE Mode*, GA22-7070.

### Other Publications

Additional information about the devices that attach to the 3880 can be found in the following manuals:

*Reference Manual for IBM 3330 Series Disk Storage Description*, GA26-1615  
*Reference Manual for IBM 3340/3344 Series Disk Storage Description*, GA26-1619  
*Reference Manual for IBM 3350 Direct Access Storage Description*, GA26-1638  
*IBM 3370 Direct Access Storage Description*, GA26-1657  
*IBM 3375 Direct Access Storage Description and User's Guide*, GA26-1666  
*IBM 3380 Direct Access Storage Device Introduction*, GC26-4491  
*Using 3380 Direct Access Storage Device in a MVS Environment*, GC26-4492  
*Using 3380 Direct Access Storage Device in a VM Environment*, GC26-4493  
*Using 3380 Direct Access Storage Device in a VSE Environment*, GC26-4494

*Maintaining Storage Subsystem Media*, GC26-4495.

Information related to 3880 Models 11, 13, 21, and 23 can be found in the following manuals:

*Introduction to IBM 3880 Storage Control Model 11*, GA32-0060  
*IBM 3880 Storage Control Model 11 Description*, GA32-0061  
*Introduction to IBM 3880 Storage Control Model 13*, GA32-0062  
*IBM 3880 Storage Control Model 13 Description*, GA32-0067  
*IBM 3880 Storage Control Model 21 Introduction*, GA32-0080  
*IBM 3880 Storage Control Model 21 Description*, GA32-0081  
*IBM 3880 Storage Control Model 23 Introduction*, GA32-0082 (see Note)  
*IBM 3880 Storage Control Model 23 Description*, GA32-0083 (see Note)  
*IBM 3880 Storage Control Model 23 Installation and Administration*, GA32-0085 (See Note).

*Note: IBM 3880 Storage Control Model 23 Introduction*, GA32-0082; *IBM 3880 Storage Control Model 23 Description*, GA32-0083; and *IBM 3880 Storage Control Model 23 Installation and Administration*, GA32-0085 can be ordered under one number, GBOF-0098.

Additional information about the channel to storage control interface can be found in the *IBM System/360 and System/370 I/O Interface Channel to Control Unit Original Equipment Manufacturers Information* manual, GA22-6974.

For definitions of terms used with direct access storage devices, see the *IBM Vocabulary for Data Processing, Telecommunications, and Office Systems*, GC20-1699.

Divider tabs are available for the major sections of this manual to provide quick reference to sense bytes, channel commands, and other frequently used information. The order number for the tabs is GX26-1663.

# Contents

<b>Chapter 1. Introduction</b> .....	<b>1-1</b>	Address Associated with Pending	
Storage Directors .....	1-2	Status .....	2-10
Device Configurations .....	1-2	Suppressible Status .....	2-11
Features .....	1-4	Contingent Connection .....	2-11
Two-Channel Switch .....	1-5	Addressing .....	2-11
Two-Channel Switch Pair .....	1-5	Channel Commands .....	2-12
Two-Channel Switch Pair, Additional ..	1-5	Control .....	2-12
Eight-Channel Switch .....	1-5	Write .....	2-12
Remote Switch .....	1-5	Read .....	2-12
Speed Matching Buffer for 3380 .....	1-5	Search .....	2-13
Speed Matching Buffer for 3375 .....	1-6	Sense .....	2-13
Block Multiplexer .....	1-6	Test I/O .....	2-13
Command Retry .....	1-6	Diagnostic .....	2-14
Record Overflow .....	1-6	Transfer-in-Channel Command .....	2-14
End of File .....	1-6		
Multitrack Operation .....	1-7	<b>Chapter 3. Fixed Block Command Set</b>	<b>3-1</b>
3330, 3333, and 3350 Attachment .....	1-7	No-Operation .....	3-2
3340 and 3344 Attachment .....	1-7	Function .....	3-2
3370 Attachment .....	1-8	Chaining Requirements .....	3-2
3375 Attachment .....	1-8	Status .....	3-2
3380 Attachment .....	1-8	Description .....	3-2
3380 Extended Attachment .....	1-9	Define Extent .....	3-3
3380 AJ4/AK4 Attachment (Feature 3005)	1-9	Function .....	3-3
		Chaining Requirements .....	3-3
		Status .....	3-3
		Description .....	3-3
		Byte 0 .....	3-4
		Byte 1 .....	3-4
		Bytes 2 and 3 .....	3-4
		Bytes 4 through 7 .....	3-4
		Bytes 8 through 11 .....	3-4
		Bytes 12 through 15 .....	3-5
		Locate .....	3-6
		Function .....	3-6
		Chaining Requirements .....	3-6
		Status .....	3-6
		Description .....	3-6
		Byte 0 .....	3-6
		Byte 1 .....	3-9
		Bytes 2 and 3 .....	3-9
		Bytes 4 through 7 .....	3-9
		Read .....	3-10
		Function .....	3-10
		Chaining Requirements .....	3-10
<b>Chapter 2. Input/Output Operations</b> ..	<b>2-1</b>		
General Description .....	2-1		
Channel Operation .....	2-1		
Channel/Storage Control Timing .....	2-2		
Data Transfer .....	2-2		
System and Selective Resets .....	2-2		
Channel Command Word .....	2-3		
Status Information .....	2-3		
System/370, 370-XA (Format 0), or			
ECPS:VSE Mode .....	2-3		
370-XA Mode (Format 1) .....	2-4		
System/370 and ECPS:VSE Mode .....	2-5		
370-XA Mode .....	2-5		
Program Status Word .....	2-7		
Status Presentation .....	2-7		
Initial Status .....	2-7		
Pending Status .....	2-9		
Status Pending Indicator .....	2-10		
Priority of Pending Status Conditions	2-10		

Status .....	3-10	Function .....	3-31
Description .....	3-10	Chaining Requirements .....	3-31
Read Initial Program Load .....	3-12	Status .....	3-31
Function .....	3-12	Description .....	3-31
Chaining Requirements .....	3-12	Trace/Dump Subcommand .....	3-31
Status .....	3-12	Format ID Subcommand .....	3-31
Description .....	3-12	Space ID and Read Data	
Write .....	3-13	Subcommand .....	3-31
Function .....	3-13	Read ID Subcommand .....	3-32
Chaining Requirements .....	3-13	Displace ID Subcommand .....	3-33
Status .....	3-13	Channel Programs .....	3-34
Description .....	3-13	Write .....	3-34
Sense .....	3-16	Read .....	3-37
Function .....	3-16		
Chaining Requirements .....	3-16	<b>Chapter 4. Count, Key, and Data</b>	
Status .....	3-16	<b>Command Set</b> .....	<b>4-1</b>
Description .....	3-16	No-Operation .....	4-3
Sense Identification .....	3-17	Function .....	4-3
Function .....	3-17	Chaining Requirements .....	4-3
Chaining Requirements .....	3-17	Status .....	4-3
Status .....	3-17	Description .....	4-3
Description .....	3-17	Recalibrate .....	4-4
Read and Reset Buffered Log .....	3-18	Function .....	4-4
Function .....	3-18	Chaining Requirements .....	4-4
Chaining Requirements .....	3-18	Status .....	4-4
Status .....	3-18	Description .....	4-4
Description .....	3-18	Seek .....	4-5
Read Device Characteristics .....	3-19	Function .....	4-5
Function .....	3-19	Chaining Requirements .....	4-5
Chaining Requirements .....	3-19	Status .....	4-5
Status .....	3-19	Description .....	4-5
Description .....	3-19	Seek Cylinder .....	4-7
Device Reserve .....	3-21	Function .....	4-7
Function .....	3-21	Chaining Requirements .....	4-7
Chaining Requirements .....	3-21	Status .....	4-7
Status .....	3-21	Description .....	4-7
Description .....	3-21	Seek Head .....	4-9
Device Release .....	3-22	Function .....	4-9
Function .....	3-22	Chaining Requirements .....	4-9
Chaining Requirements .....	3-22	Status .....	4-9
Status .....	3-22	Description .....	4-9
Description .....	3-22	Space Count .....	4-11
Unconditional Reserve .....	3-23	Function .....	4-11
Function .....	3-23	Chaining Requirements .....	4-11
Chaining Requirements .....	3-23	Status .....	4-11
Status .....	3-23	Description .....	4-11
Description .....	3-23	Set File Mask .....	4-13
Diagnostic Control .....	3-25	Function .....	4-13
Function .....	3-25	Chaining Requirements .....	4-13
Chaining Requirements .....	3-25	Status .....	4-13
Status .....	3-25	Description .....	4-13
Description .....	3-25	Set Sector .....	4-16
Subcommands .....	3-26	Function .....	4-16
Diagnostic Sense/Read .....	3-31	Chaining Requirements .....	4-16

Status .....	4-16	Search Identifier High .....	4-37
Description .....	4-16	Function .....	4-37
Restore .....	4-18	Chaining Requirements .....	4-37
Function .....	4-18	Status .....	4-37
Chaining Requirements .....	4-18	Description .....	4-37
Status .....	4-18	Search Identifier Equal or High .....	4-39
Description .....	4-18	Function .....	4-39
Suspend Multipath Reconnection .....	4-19	Chaining Requirements .....	4-39
Function .....	4-19	Status .....	4-39
Chaining Requirements .....	4-19	Description .....	4-39
Status .....	4-19	Search Key Equal .....	4-41
Description .....	4-19	Function .....	4-41
Set Path Group Identifier .....	4-20	Chaining Requirements .....	4-41
Function .....	4-20	Status .....	4-41
Chaining Requirements .....	4-20	Description .....	4-41
Status .....	4-20	Search Key High .....	4-43
Description .....	4-20	Function .....	4-43
Byte 0 .....	4-21	Chaining Requirements .....	4-43
Bytes 1 through 11 .....	4-22	Status .....	4-43
Define Extent .....	4-23	Description .....	4-43
Function .....	4-23	Search Key Equal or High .....	4-45
Chaining Requirements .....	4-23	Function .....	4-45
Status .....	4-23	Chaining Requirements .....	4-45
Description .....	4-23	Status .....	4-45
Byte 0 .....	4-24	Description .....	4-45
Byte 1 .....	4-25	Read Home Address .....	4-47
Bytes 2 and 3 .....	4-25	Function .....	4-47
Bytes 4 through 7 .....	4-25	Chaining Requirements .....	4-47
Bytes 8 through 11 .....	4-25	Status .....	4-47
Bytes 12 through 15 .....	4-25	Description .....	4-47
Locate Record .....	4-26	Read Special Home Address .....	4-48
Function .....	4-26	Function .....	4-48
Chaining Requirements .....	4-26	Chaining Requirements .....	4-48
Status .....	4-26	Status .....	4-48
Description .....	4-26	Description .....	4-48
Byte 0 .....	4-27	Read Count .....	4-49
Byte 1 .....	4-30	Function .....	4-49
Byte 2 .....	4-30	Chaining Requirements .....	4-49
Byte 3 .....	4-31	Status .....	4-49
Bytes 4 through 7 .....	4-31	Description .....	4-49
Bytes 8 through 12 .....	4-31	Read Record Zero .....	4-50
Byte 13 .....	4-31	Function .....	4-50
Bytes 14 and 15 .....	4-31	Chaining Requirements .....	4-50
Performance Factors .....	4-32	Status .....	4-50
Search Home Address Equal .....	4-33	Description .....	4-50
Function .....	4-33	Read Data .....	4-51
Chaining Requirements .....	4-33	Function .....	4-51
Status .....	4-33	Chaining Requirements .....	4-51
Description .....	4-33	Status .....	4-51
Search Identifier Equal .....	4-35	Description .....	4-51
Function .....	4-35	Read Key and Data .....	4-52
Chaining Requirements .....	4-35	Function .....	4-52
Status .....	4-35	Chaining Requirements .....	4-52
Description .....	4-35	Status .....	4-52

Description .....	4-52	Function .....	4-68
Read Count, Key, and Data .....	4-53	Chaining Requirements .....	4-68
Function .....	4-53	Status .....	4-68
Chaining Requirements .....	4-53	Description .....	4-68
Status .....	4-53	Read Device Characteristics .....	4-69
Description .....	4-53	Function .....	4-69
Read Multiple Count, Key, and Data ...	4-54	Chaining Requirements .....	4-69
Function .....	4-54	Status .....	4-69
Chaining Requirements .....	4-54	Description .....	4-69
Status .....	4-54	Write Home Address .....	4-72
Description .....	4-54	Function .....	4-72
Read Initial Program Load .....	4-56	Chaining Requirements .....	4-72
Function .....	4-56	Status .....	4-72
Chaining Requirements .....	4-56	Description .....	4-72
Status .....	4-56	3330, 3375, and 3380 Home Address	
Description .....	4-56	Area .....	4-73
Read Sector .....	4-57	3350 Home Address Area .....	4-73
Function .....	4-57	3340/3344 Home Address Area .....	4-73
Chaining Requirements .....	4-57	Write Special Home Address .....	4-74
Status .....	4-57	Function .....	4-74
Description .....	4-57	Chaining Requirements .....	4-74
Sense Identification .....	4-58	Status .....	4-74
Function .....	4-58	Description .....	4-74
Chaining Requirements .....	4-58	Write Record Zero .....	4-76
Status .....	4-58	Function .....	4-76
Description .....	4-58	Chaining Requirements .....	4-76
Sense Path Group Identifier .....	4-60	Status .....	4-76
Function .....	4-60	Description .....	4-76
Chaining Requirements .....	4-60	Erase .....	4-78
Status .....	4-60	Function .....	4-78
Description .....	4-60	Chaining Requirements .....	4-78
Byte 0 .....	4-61	Status .....	4-78
Bytes 1 through 11 .....	4-61	Description .....	4-78
Sense .....	4-62	Write Count, Key, and Data .....	4-79
Function .....	4-62	Function .....	4-79
Chaining Requirements .....	4-62	Chaining Requirements .....	4-79
Status .....	4-62	Status .....	4-79
Description .....	4-62	Description .....	4-80
Read and Reset Buffered Log .....	4-64	Write Special Count, Key, and Data ...	4-81
Function .....	4-64	Function .....	4-81
Chaining Requirements .....	4-64	Chaining Requirements .....	4-81
Status .....	4-64	Status .....	4-81
Description .....	4-64	Description .....	4-81
Device Reserve .....	4-65	Write Data .....	4-83
Function .....	4-65	Function .....	4-83
Chaining Requirements .....	4-65	Chaining Requirements .....	4-83
Status .....	4-65	Status .....	4-83
Description .....	4-65	Description .....	4-83
Unconditional Reserve .....	4-66	Write Key and Data .....	4-84
Function .....	4-66	Function .....	4-84
Chaining Requirements .....	4-66	Chaining Requirements .....	4-84
Status .....	4-66	Status .....	4-84
Description .....	4-66	Description .....	4-84
Device Release .....	4-68	Write Update Data .....	4-85



Function .....	4-85	Multitrack .....	5-1
Chaining Requirements .....	4-85	Cylinder 02 .....	5-2
Status .....	4-85	Record Overflow .....	5-3
Description .....	4-85	Formatting Overflow Records .....	5-3
Write Update Key and Data .....	4-86	Cylinder 02 .....	5-4
Function .....	4-86	Processing Overflow Records .....	5-5
Chaining Requirements .....	4-86	End of File .....	5-6
Status .....	4-86	Cylinder 02 .....	5-8
Description .....	4-86	Rotational Position Sensing .....	5-9
Write CKD Next Track .....	4-87	3330 Series .....	5-9
Function .....	4-87	3340 Series Drives .....	5-9
Chaining Requirements .....	4-87	3350 Series Drives .....	5-10
Status .....	4-87	3375 Series .....	5-10
Description .....	4-87	3380 Series .....	5-10
Diagnostic Sense .....	4-88	3340 without RPS .....	5-11
Function .....	4-88	3330, 3340/3344, 3350, 3375 or 3380	
Chaining Requirements .....	4-88	with RPS .....	5-11
Status .....	4-88	Channel Program .....	5-12
Description .....	4-88	Command Retry .....	5-13
Diagnostic Load .....	4-89	Channel Switching .....	5-13
Function .....	4-89	Channel Selection Switch .....	5-14
Chaining Requirements .....	4-89	Remote Switching .....	5-14
Status .....	4-89	Statistical Usage and/or Error Recording	5-15
Description .....	4-89	Error Detection and Logging .....	5-15
Diagnostic Write .....	4-90	Block Multiplexing .....	5-16
Function .....	4-90	Speed Matching Buffer for 3375 .....	5-16
Chaining Requirements .....	4-90	Speed Matching Buffer for 3380 .....	5-17
Status .....	4-90	I/O Operation for Speed Matching Buffer	5-17
Description .....	4-90		
Diagnostic Control .....	4-91	<b>Chapter 6. Error Recovery Procedures</b>	<b>6-1</b>
Function .....	4-91	Console Error Message .....	6-1
Chaining Requirements .....	4-91	Error Correction Function – Fixed	
Status .....	4-91	Block Devices .....	6-1
Description .....	4-91	Example .....	6-2
Byte 0 .....	4-92	Restart CCWs – Fixed Block Devices	6-3
Byte 1 .....	4-93	Restart CCW 1 .....	6-3
Bytes 2 and 3 .....	4-93	Restart CCW 2 .....	6-3
Diagnostic Sense/Read .....	4-94	Error Correction Function – Count,	
Function .....	4-94	Key, and Data Devices .....	6-4
Chaining Requirements .....	4-94	Example .....	6-6
Status .....	4-94	Restart CCWs – Count, Key, and	
Description .....	4-94	Data Devices .....	6-7
Channel Programs .....	4-95	Restart CCW 1 .....	6-7
Track Formatting .....	4-95	Restart CCW 2 .....	6-7
Update Write .....	4-100	Command Retry – 3370 .....	6-8
Read .....	4-104	Internal Retry .....	6-9
Channel Programs – 3880 with Speed		Command Retry – 3330, 3340/3344, 3350,	
Matching Buffer for 3375 or 3380 .....	4-109	3375 and 3380 .....	6-10
Track Formatting .....	4-109	Device Support Facilities .....	6-12
Update Write .....	4-113		
Read .....	4-116	<b>Chapter 7. Sense Bytes – 3370</b>	<b>7-1</b>
		Sense Byte 0 .....	7-1
<b>Chapter 5. Standard and Special</b>		Bit 0 - Command Reject .....	7-1
<b>Features</b> .....	<b>5-1</b>	Bit 1 - Intervention Required .....	7-1

Bit 2 - Bus Out Parity	7-2	Byte 15	7-10
Bit 3 - Equipment Check	7-2	Byte 16	7-10
Bit 4 - Data Check	7-2	Byte 17	7-11
Bit 5 - Overrun	7-2	Byte 18	7-11
Bit 6	7-2	Byte 19	7-11
Bit 7	7-2	Byte 20	7-12
Sense Byte 1	7-3	Byte 21	7-12
Bit 0 - Permanent Error	7-3	Bytes 22 and 23	7-12
Bit 1 - Block Size Exception	7-3	Message Table - Format 1	7-13
Bit 2	7-3	Format 2 - Storage Director	
Bit 3 - Message to Operator	7-3	Equipment Check	7-14
Bit 4	7-3	Message Table - Format 2	7-14
Bit 5 - File Protected	7-3	Format 3 - Storage Director Control	
Bit 6 - Write Inhibited	7-3	Check (Hardware Detected)	7-15
Bit 7 - Operation Incomplete	7-3	Message Table - Format 3	7-15
Sense Byte 2	7-4	Format 3 - Storage Director Control	
Bit 0 - Check Data Error	7-4	Check (Microcode Detected)	7-16
Bit 1 - Correctable	7-4	Message Table - Format 3	7-16
Bit 2 - First Logged Error	7-4	Format 4 - Data Checks Without	
Bit 3 - Environmental Data Present	7-4	Displacement Information	7-17
Bit 4	7-4	Bytes 8 through 15 - Locate	
Bit 5	7-4	Parameters	7-17
Bit 6	7-5	Bytes 16 and 17 - Blocks Transferred	7-17
Bit 7	7-5	Bytes 18 through 21 - Offset	7-17
Sense Byte 3	7-5	Bytes 22 and 23	7-17
Bits 0 through 7 - Cylinder High	7-5	Message Table - Format 4	7-18
Sense Byte 4	7-5	Format 5 - Data Checks With	
Bits 0 through 7 - Cylinder Low	7-5	Displacement Information	7-19
Sense Byte 5	7-5	Bytes 8 through 15 - Locate	
Bits 0 through 7 - Head Address, IAR,		Parameters	7-19
or Diskette Checks	7-5	Bytes 16 and 17 - Blocks Transferred	7-19
Sense Byte 6	7-6	Bytes 18 and 19 - Error Displacement	7-19
Bits 0 through 7 - Block Number, IAR,		Bytes 20 through 23 - Error Pattern	7-19
or Storage Director ID	7-6	Message Table - Format 5	7-19
Sense Byte 7	7-6	Format 6 - Usage Statistics/Overrun	
Bits 0 through 3 - Format	7-6	Errors	7-20
Bits 4 through 7 - Message Code	7-6	Bytes 8 through 10 - Blocks Read	7-20
Format 0 - Program or System Check	7-7	Bytes 11 through 13	7-20
Bytes 8 through 15 - Locate		Byte 14 - Access Offset Invoked	7-20
Parameters	7-7	Bytes 15 through 17 - Blocks Written	
Bytes 16 and 17 - Number of Blocks		with Verify	7-20
Transferred	7-7	Byte 18	7-20
Bytes 18 through 20	7-7	Bytes 19 and 20 - Seeks	7-20
Byte 21	7-7	Byte 21	7-20
Bytes 22 and 23	7-7	Byte 22 - Service Overruns	7-20
Message Table - Format 0	7-7	Byte 23 - Command Overruns	7-20
Format 1 - Device Equipment Check	7-9	Message Table - Format 6	7-21
Byte 8 - CTL-I Tag Bus	7-9	Error Condition Table - 3370	7-22
Byte 9 - CTL-I Bus Out	7-9	Recovery Action Table - 3370	7-23
Byte 10 - CTL-I Bus In	7-9		
Byte 11 - Drive Status	7-9		
Byte 12	7-9		
Byte 13	7-10		
Byte 14	7-10		
		<b>Chapter 8. Sense Bytes - 3330</b>	<b>8-1</b>
		Sense Byte 0	8-1
		Bit 0 - Command Reject	8-1
		Bit 1 - Intervention Required	8-1

Bit 2 - Bus Out Parity	8-2	Byte 17 - Controller Check 2	8-11
Bit 3 - Equipment Check	8-2	Byte 18 - Controller Check 3	8-12
Bit 4 - Data Check	8-2	Byte 19 - Controller Check 4	8-12
Bit 5 - Overrun	8-2	Bytes 20 and 21	8-12
Bit 6	8-2	Bytes 22 and 23	8-12
Bit 7	8-2	Message Table - Format 1	8-13
Sense Byte 1	8-3	Format 2 - Storage Director	
Bit 0 - Permanent Error	8-3	Equipment Check	8-14
Bit 1 - Invalid Track Format	8-3	Message Table - Format 2	8-15
Bit 2 - End of Cylinder	8-3	Format 3 - Storage Director Control	
Bit 3 - Message to Operator	8-3	Check (Hardware Detected)	8-16
Bit 4 - No Record Found	8-3	Message Table - Format 3	8-16
Bit 5 - File Protected	8-4	Format 3 - Storage Director Control	
Bit 6 - Write Inhibited	8-4	Check (Microcode Detected)	8-17
Bit 7 - Operation Incomplete	8-4	Message Table - Format 3	8-17
Sense Byte 2	8-5	Format 4 - Data Check Without	
Bit 0	8-5	Displacement Information	8-18
Bit 1 - Correctable	8-5	Bytes 8 through 12 - Count ID	8-18
Bit 2	8-5	Byte 13 - Sector Number	8-18
Bit 3 - Environmental Data Present	8-5	Byte 14 - Access Offset	8-18
Bits 4 and 5	8-5	Byte 15 - Retry Count	8-18
Bit 6 - Write Operation	8-5	Byte 16 - Source Drive ID	8-18
Bit 7	8-5	Bytes 17 through 21	8-18
Sense Byte 3	8-5	Bytes 22 and 23	8-18
Bits 0 through 7 - Restart Command	8-5	Message Table - Format 4	8-19
Sense Byte 4	8-6	Format 5 - Data Check With	
Bits 0 and 1	8-6	Displacement Information	8-20
Bits 2 through 7 Drive Identification	8-6	Bytes 8 through 12 - Count ID	8-20
Sense Byte 5	8-6	Byte 13 - Sector Number	8-20
Bits 0 through 7 - Cylinder-Low		Byte 14 - Access Offset	8-20
Address	8-6	Bytes 15 through 17	8-20
Sense Byte 6	8-7	Bytes 18 and 19	8-20
Bit 0	8-7	Bytes 20 through 22	8-20
Bit 1 - Cylinder-High Address	8-7	Byte 23	8-20
Bit 2 - Difference	8-7	Message Table - Format 5	8-21
Bits 3 through 7 - Head Address	8-7	Format 6 - Usage Statistics/Overrun	
Sense Byte 7	8-8	Errors	8-22
Bits 0 through 3 - Format	8-8	Bytes 8 through 11 - Bytes Read or	
Bits 4 through 7 - Message	8-8	Searched	8-22
Format 0 - Program or System Check	8-9	Bytes 12 and 13 - Correctable Data	
Bytes 8 through 20	8-9	Checks	8-22
Byte 21	8-9	Bytes 14 and 15 - Uncorrectable Data	
Bytes 22 and 23	8-9	Checks Retrieved	8-22
Message Table - Format 0	8-9	Bytes 16 and 17 - Number of Seeks	8-22
Format 1 - Device Equipment Check	8-10	Byte 18 - Channel Select	8-22
Byte 8 - Module Status	8-10	Byte 19 - Seek Errors	8-22
Byte 9 - Monitor Mode	8-10	Byte 20 - Command Overruns -	
Byte 10 - Monitor State	8-10	Channel A, C, E, or G	8-22
Byte 11 - Check Status	8-11	Byte 21 - Data Overruns - Channel A,	
Byte 12 - Safety	8-11	C, E, or G	8-23
Byte 13 - Device Bus Out	8-11	Byte 22 - Command Overruns -	
Byte 14 - Device Bus In	8-11	Channel B, D, F, or H	8-23
Byte 15 - Device Tag Gate	8-11	Byte 23 - Data Overruns - Channel B,	
Byte 16 - Controller Check 1	8-11	D, F, or H	8-23

Message Table – Format 6 . . . . .	8-23	Byte 12 - R/W Safety . . . . .	9-11
Error Condition Table – 3330 . . . . .	8-23	Byte 13 - Control Interface Check . .	9-11
Recovery Action Table – 3330 . . . . .	8-23	Byte 14 - Control Interface Bus In .	9-11
<b>Chapter 9. Sense Bytes – 3350 . . . . .</b>	<b>9-1</b>	Byte 15 - Control Interface Tag Bus	9-12
Sense Byte 0 . . . . .	9-1	Byte 16 - Access Status . . . . .	9-12
Bit 0 - Command Reject . . . . .	9-1	Byte 17 - Controller Check . . . . .	9-12
Bit 1 - Intervention Required . . . . .	9-1	Byte 18 - Microcode Detected Errors	9-12
Bit 2 - Bus Out Parity . . . . .	9-2	Byte 19 - Status . . . . .	9-13
Bit 3 - Equipment Check . . . . .	9-2	Byte 20 - Interface Checks . . . . .	9-13
Bit 4 - Data Check . . . . .	9-2	Byte 21 - Device Interface Check . .	9-13
Bit 5 - Overrun . . . . .	9-2	Bytes 22 and 23 . . . . .	9-14
Bit 6 . . . . .	9-2	<b>Format 2 – Storage Director</b>	
Bit 7 . . . . .	9-2	Equipment Check . . . . .	9-15
Sense Byte 1 . . . . .	9-3	Byte 21 . . . . .	9-15
Bit 0 - Permanent Error . . . . .	9-3	Bytes 22 and 23 . . . . .	9-15
Bit 1 - Invalid Track Format . . . . .	9-3	Message Table – Format 2 . . . . .	9-16
Bit 2 - End of Cylinder . . . . .	9-3	<b>Format 3 – Storage Director Control</b>	
Bit 3 - Message to Operator . . . . .	9-3	Check (Hardware Detected) . . . . .	9-17
Bit 4 - No Record Found . . . . .	9-3	Message Table – Format 3 . . . . .	9-17
Bit 5 - File Protected . . . . .	9-4	<b>Format 3 – Storage Director Control</b>	
Bit 6 - Write Inhibited . . . . .	9-4	Check (Microcode Detected) . . . . .	9-18
Bit 7 - Operation Incomplete . . . . .	9-4	Message Table – Format 3 . . . . .	9-18
Sense Byte 2 . . . . .	9-5	<b>Format 4 – Data Check Without</b>	
Bit 0 . . . . .	9-5	Displacement Information . . . . .	9-19
Bit 1 - Correctable . . . . .	9-5	Bytes 8 through 12 - Count ID . . . .	9-19
Bit 2 - Alternate Controller Selected	9-5	Byte 13 - Sector Number . . . . .	9-19
Bit 3 - Environmental Data Present .	9-5	Bytes 14 through 21 . . . . .	9-19
Bits 4 and 5 . . . . .	9-5	Bytes 22 and 23 . . . . .	9-19
Bit 6 - Write Operation . . . . .	9-5	Message Table – Format 4 . . . . .	9-20
Bit 7 . . . . .	9-5	<b>Format 5 – Data Check With</b>	
Sense Byte 3 . . . . .	9-5	Displacement Information . . . . .	9-21
Bits 0 through 7 - Restart Command .	9-5	Bytes 8 through 12 - Count ID . . . .	9-21
Sense Byte 4 . . . . .	9-6	Byte 13 - Sector Number . . . . .	9-21
Bits 0 through 7 - Drive Identification	9-6	Byte 14 . . . . .	9-21
Sense Byte 5 . . . . .	9-6	Bytes 15 through 17 . . . . .	9-21
Bits 0 through 7 - Cylinder-Low		Bytes 18 and 19 . . . . .	9-21
Address . . . . .	9-6	Bytes 20 through 22 . . . . .	9-21
Sense Byte 6 . . . . .	9-7	Byte 23 . . . . .	9-21
Bits 0 through 7 - Cylinder-High and		Message Table – Format 5 . . . . .	9-22
Head Address . . . . .	9-7	<b>Format 6 – Usage Statistics/Overrun</b>	
Sense Byte 7 . . . . .	9-8	Errors . . . . .	9-23
Bits 0 through 3 - Format . . . . .	9-8	Bytes 8 through 11 - Bytes Read or	
Bits 4 through 7 - Message . . . . .	9-8	Searched . . . . .	9-23
<b>Format 0 – Program or System Check .</b>	<b>9-9</b>	Bytes 12 and 13 . . . . .	9-23
Bytes 8 through 17 . . . . .	9-9	Bytes 14 and 15 . . . . .	9-23
Bytes 18 through 23 - Skip		Bytes 16 and 17 - Number of Seeks .	9-23
Displacement . . . . .	9-9	Byte 18 - Channel Select . . . . .	9-23
Message Table – Format 0 . . . . .	9-9	Byte 19 - Seek Errors . . . . .	9-23
<b>Format 1 – Device Equipment Check</b>	<b>9-10</b>	Byte 20 - Command Overruns -	
Byte 8 - Drive Status . . . . .	9-10	Channel A, C, E, or G . . . . .	9-23
Byte 9 - Drive Checks . . . . .	9-10	Byte 21 - Data Overruns - Channel A,	
Byte 10 - Sequence Control . . . . .	9-11	C, E, or G . . . . .	9-24
Byte 11 - Load Switch Status . . . . .	9-11	Byte 22 - Command Overruns -	
		Channel B, D, F, or H . . . . .	9-24

Byte 23 - Data Overruns - Channel B, D, F, or H . . . . .	9-24	Format 1 – Device Equipment Check	10-10
Message Table – Format 6 . . . . .	9-24	Byte 8 - Drive Status . . . . .	10-10
Error Condition Table – 3330 and 3350	9-25	Byte 9 - Drive Checks . . . . .	10-10
Recovery Action Table – 3330 and 3350	9-27	Byte 10 - DM Sequence Control . . .	10-10
<b>Chapter 10. Sense Bytes – 3340 and</b>		Byte 11 - Load Switch Status . . . .	10-11
<b>3344 . . . . .</b>	<b>10-1</b>	Byte 12 - R/W Safety . . . . .	10-11
Sense Byte 0 . . . . .	10-1	Byte 13 - Control Interface Check . .	10-11
Bit 0 - Command Reject . . . . .	10-1	Byte 14 - Control Interface Bus In .	10-11
Bit 1 - Intervention Required . . . .	10-1	Byte 15 - Control Interface Tag Bus	10-12
Bit 2 - Bus Out Parity Check . . . .	10-2	Byte 16 - Access Status . . . . .	10-12
Bit 3 - Equipment Check . . . . .	10-2	Byte 17 - Controller Checks . . . . .	10-12
Bit 4 - Data Check . . . . .	10-2	Byte 18 - Microcode Detected Errors	10-12
Bit 5 - Overrun . . . . .	10-2	Byte 19 - Status . . . . .	10-13
Bit 6 - Track Condition Check . . . .	10-2	Byte 20 - Interface Checks . . . . .	10-13
Bit 7 - Seek Check . . . . .	10-2	Byte 21 . . . . .	10-13
Sense Byte 1 . . . . .	10-3	Bytes 22 and 23 . . . . .	10-14
Bit 0 . . . . .	10-3	Message Table – Format 1 . . . . .	10-14
Bit 1 - Invalid Track Format . . . . .	10-3	Format 2 – Storage Director	
Bit 2 - End of Cylinder . . . . .	10-3	Equipment Check . . . . .	10-15
Bit 3 - Message to Operator . . . . .	10-3	Message Table – Format 2 . . . . .	10-15
Bit 4 - No Record Found . . . . .	10-3	Format 3 – Storage Director Control	
Bit 5 - File Protected . . . . .	10-3	Check (Hardware Detected) . . . . .	10-16
Bit 6 - Write Inhibited . . . . .	10-4	Message Table – Format 3 . . . . .	10-16
Bit 7 - Operation Incomplete . . . . .	10-4	Format 3 – Storage Director Control	
Sense Byte 2 . . . . .	10-4	Check (Microcode Detected) . . . . .	10-17
Bit 0 - RPS Present . . . . .	10-4	Message Table – Format 3 . . . . .	10-17
Bit 1 - Correctable . . . . .	10-4	Format 4 – Data Check Without	
Bit 2 . . . . .	10-4	Displacement Information . . . . .	10-18
Bit 3 - Environmental Data Present	10-5	Bytes 8 through 12 - Count ID . . . .	10-18
Bit 4 - Drive Type . . . . .	10-5	Byte 13 - Sector Number . . . . .	10-18
Bits 5 through 7 - Data Storage Size	10-5	Byte 14 through 21 . . . . .	10-18
Sense Byte 3 . . . . .	10-5	Bytes 22 and 23 . . . . .	10-18
Bits 0 through 7 - Restart Command	10-5	Message Table – Format 4 . . . . .	10-19
Sense Byte 4 . . . . .	10-6	Format 5 – Data Check With	
Bits 0 through 7 - 3340 Drive		Displacement Information . . . . .	10-20
Identification . . . . .	10-6	Bytes 8 through 12 - Count ID . . . .	10-20
Bits 0 through 7 - 3344 Drive		Byte 13 - Sector Number . . . . .	10-20
Identification . . . . .	10-6	Byte 14 . . . . .	10-20
Sense Byte 5 . . . . .	10-6	Bytes 15 through 17 . . . . .	10-20
Bits 0 through 7 - Cylinder-Low		Bytes 18 and 19 . . . . .	10-20
Address . . . . .	10-6	Bytes 20 through 22 . . . . .	10-20
Sense Byte 6 . . . . .	10-7	Byte 23 . . . . .	10-20
Bits 0 through 7 - Cylinder-High and		Message Table – Format 5 . . . . .	10-21
Head Address . . . . .	10-7	Format 6 – Usage Statistics/Overrun	
Sense Byte 7 . . . . .	10-7	Errors . . . . .	10-22
Bits 0 through 3 - Format . . . . .	10-7	Bytes 8 through 11 - Bytes Read or	
Bits 4 through 7 - Message Code . . .	10-7	Searched . . . . .	10-22
Format 0 – Program or System Check	10-8	Bytes 12 through 15 . . . . .	10-22
Bytes 8 through 20 . . . . .	10-8	Bytes 16 and 17 - Number of Seeks .	10-22
Byte 21 . . . . .	10-8	Byte 18 - Channel Select . . . . .	10-22
Bytes 22 and 23 - Skip Displacement	10-8	Byte 19 . . . . .	10-22
Message Table – Format 0 . . . . .	10-8	Byte 20 - Command Overruns -	
		Channel A or C . . . . .	10-22

Byte 21 - Data Overruns - Channel A or C	10-23	Bytes 8 through 19	11-9
Byte 22 - Command Overruns - Channel B or D	10-23	Byte 20	11-9
Byte 23 - Data Overruns - Channel B or D	10-23	Byte 21	11-9
Message Table - Format 6	10-23	Bytes 22 and 23	11-9
Error Condition Table - 3340 and 3344	10-24	Message Table - Format 0 (Byte 1, Bit 3 = 0)	11-9
Recovery Action Table - 3340 and 3344	10-26	Message Table - Format 0 (Byte 1, Bit 3 = 1)	11-10
<b>Chapter 11. Sense Bytes - 3375</b>	<b>11-1</b>	Format 1 - Device Equipment Check	11-11
Sense Byte 0	11-1	Byte 8 - CTL-I Tag Bus	11-11
Bit 0 - Command Reject	11-1	Byte 9 - CTL-I Bus Out	11-11
Bit 1 - Intervention Required	11-2	Byte 10 - CTL-I Bus In	11-11
Bit 2 - Bus Out Parity	11-2	Byte 11 - Drive Status	11-11
Bit 3 - Equipment Check	11-2	Byte 12 - Sense Interface	11-12
Bit 4 - Data Check	11-2	Byte 13	11-12
Bit 5 - Overrun	11-2	Byte 14	11-12
Bit 6	11-3	Byte 15	11-12
Bit 7	11-3	Byte 16	11-12
Sense Byte 1	11-3	Byte 17	11-13
Bit 0 - Permanent Error	11-3	Byte 18	11-13
Bit 1 - Invalid Track Format	11-3	Byte 19	11-13
Bit 2 - End of Cylinder	11-3	Byte 20	11-14
Bit 3 - Message to Operator	11-3	Byte 21	11-14
Bit 4 - No Record Found	11-4	Bytes 22 and 23	11-15
Bit 5 - File Protected	11-4	Message Table - Format 1	11-15
Bit 6 - Write Inhibited	11-4	Format 2 - Storage Director Equipment Check	11-16
Bit 7	11-4	Message Table - Format 2	11-17
Sense Byte 2	11-4	Format 3 - Storage Director Control Check (Hardware Detected)	11-18
Bit 0	11-4	Message Table - Format 3	11-18
Bit 1 - Correctable	11-5	Format 3 - Storage Director Control Check (Microcode Detected)	11-19
Bit 2 - First Logged Error	11-5	Message Table - Format 3	11-19
Bit 3 - Environmental Data Present	11-5	Format 4 - Data Check Without Displacement Information	11-20
Bit 4 - Intent Violation	11-5	Bytes 8 through 12 - Record Identification	11-20
Bit 5 - Imprecise Ending	11-5	Byte 13 - Sector Number	11-20
Bits 6 and 7	11-6	Byte 14 - Controller Physical Address	11-20
Sense Byte 3	11-6	Byte 15 - Access Offset	11-20
Sense Byte 4	11-6	Bytes 16 through 20	11-20
Bit 0	11-6	Byte 21	11-20
Bits 1 and 2	11-6	Bytes 22 and 23	11-21
Bits 3 and 4 - Controller Address	11-6	Message Table - Format 4	11-21
Bits 5 through 7 - Device Address	11-6	Format 5 - Data Check With Displacement Information	11-22
Sense Byte 5	11-7	Bytes 8 through 12 - Count ID	11-22
Bits 0 through 7 - Cylinder-Low Address	11-7	Byte 13 - Sector Number	11-22
Sense Byte 6	11-7	Byte 14 - Controller Physical Address	11-22
Bits 0 through 7 - Cylinder-High and Head	11-7	Bytes 15 through 17 - Restart Displacement	11-22
Sense Byte 7	11-8		
Bits 0 through 3 - Format	11-8		
Bits 4 through 7 - Message	11-8		
Format 0 - Program or System Check	11-9		

Bytes 18 and 19 - Error		Bit 0	12-7
Displacement	11-22	Bit 1	12-7
Bytes 20 and 21 - Error Pattern	11-22	Bit 2	12-7
Bytes 22 and 23	11-23	Bit 3	12-7
Message Table - Format 5	11-23	Bit 4	12-7
Format 6 - Usage Statistics/Overrun		Bit 5	12-7
Errors	11-24	Bit 6	12-7
Bytes 8 through 11 - Bytes Read or		Bit 7	12-7
Searched	11-24	Bits 0 and 1	12-8
Bytes 12 through 15	11-24	Bit 2	12-8
Bytes 16 and 17 - Number of Seeks	11-24	Bit 3	12-8
Byte 18	11-24	Bit 4	12-8
Byte 19 - Data Overruns	11-24	Bit 5	12-8
Byte 20 - Command Overruns	11-24	Bit 6	12-8
Byte 21	11-24	Bit 7	12-8
Bytes 22 and 23	11-24	Sense Byte 5	12-8
Message Table - Format 6	11-25	Bits 0 through 7 - Cylinder-Low	
Error Condition Table - 3375	11-26	Address	12-8
Recovery Action Table - 3375	11-28	Sense Byte 6	12-9
<b>Chapter 12. Sense Bytes - 3380</b>	<b>12-1</b>	Bits 0 through 7 - Cylinder-High and	
Sense Byte 0	12-1	Head	12-9
Bit 0 - Command Reject	12-1	Sense Byte 7	12-9
Bit 1 - Intervention Required	12-2	Bits 0 through 3 - Format	12-9
Bit 2 - Bus Out Parity	12-2	Bits 4 through 7 - Message	12-9
Bit 3 - Equipment Check	12-2	Format Identifier	12-10
Bit 4 - Data Check	12-2	Format 0 - Program or System Check	12-11
Bit 5 - Overrun	12-2	Bytes 8 through 19	12-11
Bit 6	12-3	Byte 20	12-11
Bit 7	12-3	Byte 21	12-11
Sense Byte 1	12-3	Bytes 22 and 23	12-11
Bit 0 - Permanent Error	12-3	Message Table - Format 0 (Byte 1, Bit	
Bit 1 - Invalid Track Format	12-3	3 = 0)	12-11
Bit 2 - End of Cylinder	12-3	Format 1 - Device Equipment Check	12-13
Bit 3 - Message to Operator	12-4	Message Table - Format 1	12-18
Bit 4 - No Record Found	12-4	Format 2 - Storage Director	
Bit 5 - File Protected	12-4	Equipment Check	12-19
Bit 6 - Write Inhibited	12-4	Message Table - Format 2	12-20
Bit 7	12-4	Format 3 - Storage Director Control	
Sense Byte 2	12-5	Check (Hardware Detected)	12-21
Bit 0 - Request Write Inhibit	12-5	Message Table - Format 3	12-21
Bit 1 - Correctable	12-5	Format 3 - Storage Director Control	
Bit 2 - First Logged Error	12-5	Check (Microcode Detected)	12-22
Bit 3 - Environmental Data Present	12-5	Message Table - Format 3	12-22
Bit 4 - Intent Violation	12-5	Format 4 - Data Check Without	
Bit 5 - Imprecise Ending	12-6	Displacement Information	12-23
Bit 6 - Write Operations	12-6	Bytes 8 through 12 - Record	
Bit 7 - Model 3 with 3380 AJ4/AK4		Identifier	12-24
Attachment (Feature 3005)	12-6	Byte 13 - Sector Number	12-24
Sense Byte 3	12-6	Byte 14 - Controller - Physical	
Bit 0	12-6	Identifier	12-24
Bits 1 through 6	12-7	Byte 15 - Offset Level	12-24
Bit 7	12-7	Byte 16 - ECC Status	12-24
Sense Byte 4	12-7	Byte 17	12-24
		Bytes 18 through 20	12-25

Byte 17	12-24
Bytes 18 through 20	12-25
Byte 21	12-25
Bytes 22 and 23	12-25
Message Table – Format 4	12-26
Format 5 – Data Check with	
Displacement Information	12-27
Bytes 8 through 12 - Record	
Identification	12-28
Byte 13 - Sector Number	12-28
Byte 14 - Controller - Physical	
Identifier	12-28
Bytes 15 through 17 - Restart	
Displacement	12-28
Bytes 18 and 19 - Error	
Displacement	12-28
Bytes 20 through 23 - Error Pattern	12-28
Message Table – Format 5	12-29
Format 6 – Usage Statistics/Overrun	
Errors	12-30
Bytes 8 through 11 - Bytes Read or	
Searched	12-30
Bytes 12 through 15	12-30
Bytes 16 and 17 - Number of Seeks	12-30
Byte 18	12-30
Byte 19 - Command Overruns	12-30
Byte 20 - Data Overruns	12-30
Byte 21	12-30
Bytes 22 and 23	12-30
Message Table – Format 6	12-31
Format 7 – Storage	
Director-to-Controller Path or	
Controller Checks	12-32
Byte 8	12-32
Byte 9	12-32
Byte 10	12-32

Byte 11	12-32
Bytes 12 and 13	12-32
Bytes 14 and 15	12-32
Bytes 16 and 17	12-33
Bytes 18 and 19	12-33
Byte 20	12-33
Byte 21	12-34
Bytes 22 and 23	12-34
Message Table – Format 7	12-36
Format 8 – Controller Equipment	
Check	12-37
Message Table – Format 8	12-41
Format 9 – Device Read/Write	
Equipment Check	12-42
Message Table – Format 9	12-43
Error Condition Table – 3380	12-44
Recovery Action Table – 3380	12-46

<b>Chapter 13. Operator Panel</b>	<b>13-1</b>
Subsystem Power	13-1
System Configuration	13-2
Unit Emergency	13-2

<b>Appendix A. Appendix - Device</b>	
<b>Addressing</b>	<b>A-1</b>
3330, 3333, and 3350 Addressing	A-2
3340 and 3344 Addressing	A-2
3370 Addressing	A-3
3375 Addressing	A-6
3380 Addressing	A-6
Physical Identifiers	A-7
Storage Director Identifiers	A-7
Device Identifiers	A-8

<b>Index</b>	<b>X-1</b>
--------------	------------



## Figures

2-1.	Channel Command Word Formats	2-4	5-2.	Overflow Record	5-4
3-1.	Summary of the Fixed Block Command Set	3-1	5-3.	End of File	5-8
4-1.	Summary of Count, Key, and Data Command Set	4-2	5-4.	RPS for Write Verification	5-12
4-2.	Description of Set File Mask Bits	4-14	13-1.	3380 Operator Panel	13-1
4-3.	Format of Sense Identification Bytes	4-59	A-1.	Valid Devices Addresses	A-1
4-4.	Read Device Characteristics, Bytes 0 through 63	4-70	A-2.	Valid Address Ranges for 3340-Only Configurations	A-4
5-1.	Multitrack	5-2	A-3.	Valid Address Ranges for Mixed 3340 and 3344 Configurations	A-5
			A-4.	Physical ID Assignment	A-8

## Summary of Amendments

### Tenth Edition

This edition includes information about the 3380 AJ4/AK4 Attachment (Feature 3005) which allows the 3380 to attach 3380 Models AJ4/BJ4 and AK4/BK4. The major changes to this manual may be found under the following headings:

- 3380 AJ4/AK4 Attachment (Feature 3005)
- Count, Key, and Data Command Set
  - Seek
  - Seek Cylinder
  - Set File Mask
  - Define Extent
  - Locate Record

- Sense Identification
- Read Device Characteristics
- Diagnostic Control
- Sense Byte 2 - 3380
- Sense Byte 3 - 3380
- Sense Byte 4 - 3380
- Sense Byte 5 - 3380
- Format Identifier
- Formats 1 through 9
- Error Condition Table - 3380.

In addition, miscellaneous technical and editorial changes have been made throughout this manual.

## Chapter 1. Introduction

The IBM 3880 Storage Control Models 1, 2, 3, and 4 provide the logical capabilities to operate and control IBM disk storage devices. Each model of the 3880 provides different device attachment capabilities to satisfy the disk storage requirements for the following IBM systems and processors.

System/Processor	Direct Access Storage
4341, 4361 Model Groups 4 and 5 4381 Model Groups 1 and 2 (See Note 1)	3330/3333, 3340/3344, 3350, 3370, 3375, 3380
4331 Model Group 2 (See Note 1)	3330/3333, 3340/3344, 3350, 3370, 3375 (See Note 2)
System/370 Models 135 and 135-3	3330/3333, 3340/3344, 3350
System/370 Models 145 and 145-3	3330/3333, 3340/3344, 3350, 3375
System/370 Models 158 and 158-3	3330/3333, 3340/3344, 3350, 3375, 3380 (See Note 3)
3031, 3032, 3033, 3061, 3063, 3084, 3090, 3041, 3042-2, 9081, 9083, 9370 with Feature 6003	3330/3333, 3340/3344, 3350, 3375, 3380

### Notes:

- 1. The 3880 Model 4 attaches only to 4361 Model Groups 4 and 5; 4381 Model Groups 1, 2, and 3; 4331 Model Group 2, and 4341. Only 3370 and 3375 can be attached via the 3880 Model 4.*
- 2. Only 3370 Model A1/B1.*
- 3. 3380 Models AA4, A04, and B04 only.*

Disk storage attachment to each model of the 3880 is described in the Device Configurations section of this manual. Depending on the type of disk storage attached, the 3880 attaches to the system through standard or data streaming, block-multiplexer channels.

# Storage Directors

All 3880 Models 1, 2, and 3 contain two storage directors. The 3880 Model 4 contains only one storage director. Each storage director operates independently so that each one provides the basic functions for storage control. That is, each storage director has its own data path, control path, and address for channel communication.

Through use of diskettes, each storage director can be initialized to attach the following types of disk storage devices:

- IBM 3340 and 3344
- IBM 3330, 3333, and 3350
- IBM 3370
- IBM 3375
- IBM 3380.

The five disk storage options listed above are mutually exclusive on a storage director. For example, 3370s cannot be attached to a storage director initialized for 3340s and 3344s, and 3340s and 3344s cannot be attached to a storage director initialized for 3330, 3333, and 3350 disk storage.

When a storage director is initialized to attach 3370 disk storage, it implements the command set required for fixed block channel programs. The 3880 implements the count, key, and data (CKD) command set for all other disk storage devices.

## Device Configurations

The following chart illustrates the various device configurations that may be attached to each model of the 3880.

Model	Storage Director 1	Storage Director 2
1	Up to 4 strings of 3330/3333/ 3350s or Up to 4 strings of 3340/3344s or Up to 4 strings of 3370s or Up to 4 strings of 3375s	Up to 4 strings of 3330/3333/ 3350s or Up to 4 strings of 3340/3344s or Up to 4 strings of 3370s or Up to 4 strings of 3375s
2	Up to 4 strings of 3330/3333/ 3350s or Up to 4 strings of 3340/3344s  Up to 4 strings of 3370s or Up to 4 strings of 3375s	Up to 2 strings of 3380s (Models AA4, A04 and B04 only)

<b>Model</b>	<b>Storage Director 1</b>	<b>Storage Director 2</b>
3	Up to 2 strings of 3380s	Up to 2 strings of 3380s
4	Up to 4 strings of 3370s or Up to 4 strings of 3375s	Not available on Model 4

Each storage director must be initialized for the desired device configuration, and is subject to the limitations described in “3330, 3333, and 3350 Attachment” on page 1-7; “3340 and 3344 Attachment” on page 1-7; “3370 Attachment” on page 1-8; “3375 Attachment” on page 1-8; “3380 Attachment” on page 1-8; “3380 Extended Attachment” on page 1-9; and “3380 AJ4/AK4 Attachment (Feature 3005)” on page 1-9. Storage directors that attach 3380 Model AA4, A04/B04 must either be attached to a 3-megabyte per second block-multiplexer channel, which can operate in data streaming mode, or they must have the speed matching buffer feature for 3380s. Storage directors that attach 3380 Model AD4, AE4, AJ4, or AK4 must be attached to a 3-megabyte per second block-multiplexer channel that can operate in data streaming mode. Attachment of 3375s without the speed matching buffer feature to the 3031, 3032, 3033, or 3042 Model 2 requires the data streaming feature on the processor.

When a 3880 Model 1 or 2 is attached to a 4341, 4361, or 4381, the storage directors attaching 3350, 3370, or 3375 disk storage must be attached to either a 2- or 3-megabyte per second block-multiplexer channel. When a 3880 Model 4 is attached to a 4331, 4341, 4361, or 4381, the attaching 3370 or 3375 must be attached to a 2-megabyte per second block-multiplexer channel. Storage directors attaching 3330/3333 or 3340/3344 disk storage may be attached to either a 1-, 2-, or 3-megabyte per second block-multiplexer channel.

The corresponding Channel Speed Control switch in the 3880 should be turned on if the 3880 is attached to a channel capable of operating in data streaming mode. On a 3380 speed matching buffer (only) attached to a data streaming channel with a data rate less than 3 megabytes per second, the 3880 Channel Speed Control switch must be set for offset interlock. On a 3375 speed matching buffer (only) the Channel Speed Control switch must be set for offset interlock when the data streaming channel data rate is less than 2 megabytes per second. The Channel Speed Control switch should be set by a customer engineer when the 3880 is installed.

# Features

The 3880 is available with or supports the following standard and special features:

Feature	3330 3333 3350	3340 3344	3370	3375	3380 Models AA4, A04, B04	3380 Models AD4/BD4, AE4/BE4, AJ4/BJ4, AK4/BK4
Two-Channel Switch (Model 4)	No	No	Yes	Yes	No	No
Two-Channel Switch Pair	Yes	Yes	Yes*	Yes*	Yes	Yes
Two-Channel Switch Pair, Additional	Yes	Yes	Yes*	Yes*	Yes	Yes
Eight-Channel Switch	Yes	No	No	No	Yes	Yes
Remote Switch	Yes	Yes	Yes*	Yes*	Yes	Yes
Speed Matching Buffer	No	No	No	Yes*	Yes	No
Block Multiplexer	Yes	Yes	Yes	Yes	Yes	Yes
Command Retry	Yes	Yes	Yes	Yes	Yes	Yes
Record Overflow	Yes	Yes	N/A	No	No	No
End of File	Yes	Yes	N/A	Yes	Yes	Yes
Multitrack Operation	Yes	Yes	N/A	Yes	Yes	Yes

*Note: \*Not available on 3880 Model 4.*

A brief description of these features follows. For a detailed description see Chapter 5, "Standard and Special Features" on page 5-1. In addition to these features, the 3880 also supports the device features listed in the following sections of this manual: "3330, 3333, and 3350 Attachment" on page 1-7; "3340 and 3344 Attachment" on page 1-7; "3370 Attachment" on page 1-8; "3375 Attachment" on page 1-8; "3380 Attachment" on page 1-8; "3380 Extended Attachment" on page 1-9; and "3380 AJ4/AK4 Attachment (Feature 3005)" on page 1-9.

## **Two-Channel Switch**

The two-channel switch feature (3880 Model 4 only) allows the storage director to be shared by two channels. The channels may be attached to the same processor or to different processors.

## **Two-Channel Switch Pair**

The two-channel switch pair feature (3880 Models 1, 2, and 3) provides logically separated switching facilities for both storage directors. It allows each storage director to be shared by two channels. The channels may be attached to the same processor or to different processors. Individual drives attached to a storage director may be reserved for the exclusive use of either of the channels. This feature is not available for a 3880 Model 4.

## **Two-Channel Switch Pair, Additional**

The two-channel switch pair, additional feature (similar to a two-channel switch pair feature) enables four channels to share a storage director and its attached drives. This feature is not available for a 3880 Model 4.

## **Eight-Channel Switch**

The eight-channel switch feature is similar to the other channel switch features except that it enables eight channels to share both storage directors and their attached drives. This feature is available with 3330, 3333, 3350, and 3380 disk storage. This feature is not available for a 3880 Model 4.

## **Remote Switch**

The remote switch feature removes the Enable/Disable switches from the 3880 operator panel and relocates them to a remote location. This allows an operator to reconfigure the system from a central point. This feature is not available for a 3880 Model 4.

## **Speed Matching Buffer for 3380**

The speed matching buffer for 3380 feature allows 3380 Models AA4, A04, and B04 to attach to block-multiplexer channels with a data rate less than 3 megabytes per second. This feature is required to attach 3380s to System/370 Models 158, 158-3, 168, and 168-3, to the 2-megabyte channels on 4341, and to block-multiplexer channels without data streaming on the 3031, 3032, 3033, and 3042-2. The speed matching buffer cannot be used with the 3380 Extended Attachment on the Model 3 or if the 3380 AJ4/AK4 Attachment (Feature 3005) is installed.

## **Speed Matching Buffer for 3375**

The speed matching buffer for 3375 feature allows 3375s to attach to block-multiplexer channels that operate at data rates as low as 1.5 megabytes per second. This capability allows sharing of 3375s by processors with different block-multiplexer channel speeds while still taking advantage of the high-speed channels.

This feature is required to attach 3375s to System/370 Models 145, 148, 155, 158, 158-3, 165, 168, and 168-3, and to block-multiplexer channels without data streaming on the 3031, 3032, 3033, and 3042-2. This feature is not available for a 3880 Model 4.

## **Block Multiplexer**

The block multiplexer feature allows a storage director to disconnect from the channel during mechanical delays caused by commands that require repositioning of the access mechanism or excessive rotational delay.

## **Command Retry**

Command retry is a channel/storage director procedure that allows a command in the channel program to be re-executed without causing an I/O interrupt. It is a standard feature on all devices. However, its application varies with the specific device type.

## **Record Overflow**

The record overflow feature allows a storage director to process logical records that exceed the capacity of a track. When using overflow records, the hardware factor limiting the size of the record that can be processed is the cylinder boundary.

Record overflow is a standard feature on 3330, 3333, 3340, 3344, and 3350 devices; it is not applicable on 3370s, 3375s, or 3380s.

## **End of File**

An end-of-file record defines the end of a logical group of records. It is written by executing a Write Count, Key, and Data command with a data length of zero. Execution of the command by the storage director instructs a drive (except the 3375 and 3380) to write a data area consisting of 1 byte of zeros. The 3380 writes a data area of 20 bytes of zeros and 12 bytes of error correction code. The 3375 writes 20 bytes of sync area, 32 bytes of zeros, and 12 bytes of error correction code.

End of file is a standard feature for all devices except the 3370; it is not applicable on 3370s because of the fixed block format used with these devices.



## Multitrack Operation

On all search and most read commands, a storage director can automatically select the next sequentially numbered head on a drive. This eliminates the need for Seek Head commands in a chain of read or search commands.

The multitrack feature is standard for all devices except 3370s; it is not applicable on 3370s because of the fixed block format used with these devices.

## 3330, 3333, and 3350 Attachment

When initialized for 3330, 3333, and 3350 operations, each storage director can attach up to four strings of 3330/3333 and/or 3350 disk storage. The first device on a 3330/3333 string must be a 3333 Model 1 or 11. Each 3333 may attach up to three 3330 Models 1, 2, or 11 in any combination.

The first device on a 3350 string must be a 3350 Model A2 or A2F. Each 3350 Model A2 or A2F may attach up to three 3350 Model B2s or B2Fs or up to two 3350 Model B2s or B2Fs and one 3350 Model C2 or C2F. The 3350s must operate in native mode.

Strings of 3330/3333s and 3350s may be intermixed on the same storage director.

The 3880 supports the following 3330, 3333, and 3350 features:

- Rotational position sensing
- String switch option
- Remote switch
- 3350 fixed head option
- 3350 alternate controller feature.

These features are described in the *Reference Manual for IBM 3350 Direct Access Storage Description* and in the *Reference Manual for IBM 3330 Series Disk Storage Description*.

## 3340 and 3344 Attachment

Each storage director, when initialized for 3340 and 3344 operation, can attach up to four strings of 3340s and 3344s. With the following limitations, the 3340s and 3344s may be intermixed on the same strings.

- On all strings, the first unit must be a 3340 Model A2.
- On strings 0 and 2, one, two or three 3340 Model B2s or 3344 Model B2s may attach in any order or combination. A 3340 Model B1 may replace one B2 at the end of the string.
- On string 1, one, two, or three 3340 Model B2s may be attached. A 3340 Model B1 may replace one B2 at the end of the string.
- On string 3, one 3340 Model B1 or B2 may be attached.

A maximum of 28 physical drives are allowed with a maximum of 64 logical device addresses.

The 3880 supports the following device features:

- String switch option
- Remote switch
- Rotational position sensing
- Fixed head option.

These features are described in the *Reference Manual for IBM 3340/3344 Disk Storage Description*.

### **3370 Attachment**

When initialized for 3370 operation, each storage director can attach up to four strings (16 physical spindles or 32 logical device addresses) of 3370 Disk Storage devices. The first unit on a string must be a 3370 Model A1 or A2; up to three 3370 Model B1s or B2s may be attached to the Model A1 or A2.

The 3880 supports the 3370 string switch feature. This feature is described in *IBM 3370 Direct Access Storage Description*.

### **3375 Attachment**

When initialized for 3375 operation, a storage director can attach up to four strings (32 logical device addresses) of 3375 disk storage. The first unit on a string must be a Model A1. Up to three additional Model B1s may be attached to the first unit.

The 3375 Model D1 contains another controller that provides an additional path to each actuator in the string. A Model D1 can only be used in a complete string of four units and replaces the last Model B1 in the string.

The 3880 supports the string switch feature that is available with the 3375. This feature is described in the *IBM 3375 Direct Access Storage Description and User's Guide*.

### **3380 Attachment**

When initialized for 3380 operation, each storage director can attach up to two strings (32 logical device addresses) of 3380 disk storage. The first unit on a string must be a Model A04, or AA4. Up to three additional Model B04s may be attached to the first unit on a string.

The 3880 supports the dynamic path selection function available with 3380 Model AA4. Models AA4 cannot share the same storage director as Models A04.

The 3380 attachment does not support the 3380 Models AD4/BD4, AE4/BE4, AJ4/BJ4 or AK4/BK4.

The 3380 Models AA4, A04, and B04 are described in greater detail in the *IBM 3380 Direct Access Storage: General Information*.

## **3380 Extended Attachment**

Up to two 3380 strings headed by Models AA4, AD4 or AE4 can attach to each storage director in a 3380 Model 3 if the 3380 Extended Attachment feature is installed. (This consists of the 3380 AD4/AE4 Support Feature #8173 and 3380 EXTENDED Specify code #9208.) A 3380 Model AD4 can support up to three BD4/BE4s in the same string. Similarly, a 3380 Model AE4 can support up to three BD4/BE4s in the same string. 3380 Models AA4/B04 cannot be intermixed in the same string with AD4/BD4 or AE4/BE4 models; however, an AA4/B04 string can attach to the same storage directors as a string headed by either an AD4 or AE4 model.

The 3380 supports the dynamic path selection function available with 3380 Models AA4, AD4, and AE4.

The 3380 supports the device level selection function available with 3380 Models AD4 and AE4.

The 3380 Extended Attachment does not support the 3380 Models AJ4/BJ4 and AK4/BK4. The speed matching buffer is not supported with this attachment.

A 3380 Model AA4, AD4, or AE4 cannot attach to two storage directors that share the same channel. The two storage directors must have different channels. The channels may be on the same or different processors.

The 3380 is described in greater detail in the *IBM 3380 Direct Access Storage: General Information*.

## **3380 AJ4/AK4 Attachment (Feature 3005)**

With the 3380 AJ4/AK4 Attachment (Feature 3005) installed on a Model 3, the feature:

- Allows attachment of 3380 Models AJ4/BJ4 and AK4/BK4. These devices offer the following advantages:
  - Improved Error Correction Code (ECC).
  - 3380 Model AK4/BK4 offers triple the capacity of the AD4/BD4.
- Continues to support 3380 Models AD4/BD4 and AE4/BE4.
- Provides correction of ECC correctable data checks on data as well as count and key fields by the Storage Director.
- Supports the device support authorization modes in Set File Mask command (bits 5 and 6).

- Requires that:
  - A Seek, Seek Cylinder, Read IPL, or Recalibrate command must precede all commands, such as Read and Search, used for accessing data.
  - If Feature 3005 is installed on a 3880 Model 3, DASD units cannot be shared with another 3880 Model 3 that does not have Feature 3005 installed.
  - The alternate tracks for the following 3380 models must be:

3380 Model	Cylinder
D, J	885
E	1770
K	2655

- Does not support:
  - 3380 Model A04, AA4/B04
  - Static switch feature
  - 3880 Model 3's with serial numbers below 20200.

*Note: The AJ4/AK4 3880 Storage Control Attachment Feature 9431 must be installed on the 3880 AJ4 or AK4 unit that is attached to a 3880 Model 3 or 23 Storage Control. Feature 3005 or 3010 must be installed on the 3880 Model 3 or 23, respectively.*

## Chapter 2. Input/Output Operations

### General Description

Input/output (I/O) operations, initiated by I/O instructions in the system control program, are controlled by commands fetched from main storage by the channel.

Typically, I/O instructions executed by the processor can:

- Initiate a channel program.
- Force premature end of a channel program.
- Resume a suspended channel program.
- Collect status about the condition of the I/O system components (for example: channel, storage director, and drive).
- Clear (reset) the state of I/O system components.

For a detailed description of the I/O instructions and the functions provided, see the appropriate Principle of Operations manual:

- *IBM System/370 Extended Architecture Principles of Operation.*
- *IBM System/370 Principles of Operation.*
- *IBM 4300 Processors Principles of Operation for ECPS:VSE Mode.*

### Channel Operation

After successful execution of an I/O instruction which starts a channel program, the channel may independently select and govern the storage director and drive addressed by the instruction. Main storage locations contain commands and data that enable the channel to do those functions necessary to complete the operation.

## Channel/Storage Control Timing

Under expected normal conditions, the 3880 may add up to 160 microseconds to initial selection time and may delay up to 124 microseconds before propagating the requested channel selection tag because of a withdrawal of the request.

### Data Transfer

During non-streaming read, write, or search data transfer operations, the 3880 may drop each inbound tag after keeping it up for a minimum time period as shown below. The inbound tag may drop even if a response from the channel is not received.

Disk Storage	Minimum Inbound Tag Duration (Nanoseconds)
3330/3333	1045
3340/3344	940
3350	730
3370	420
3375	420
3375 (speed matching buffer)	630
3380 (speed matching buffer)	630

The 3880 may issue as many as three inbound tags before an outbound tag is received.

The 3880 may raise an inbound tag while the corresponding outbound tag is still active.

If the duration of a corresponding channel outbound tag is less than 80 nanoseconds, a channel overrun condition is detected.

Following the signaling of a stop, the channel may still receive one or more data transfer requests.

For additional information about the channel interface, see *IBM System/360 and System/370 I/O Interface Channel to Control Unit Original Equipment Manufacturers' Information*.

## System and Selective Resets

A system reset is issued during power on to all units attached to the system or when the reset switch is activated. The units may be in a selected or not-selected condition at the time of the reset.

Because the storage director and drives may be not-selected by the issuing system, a system reset must wait until the interface for this channel can be selected. When the interface for this channel is selected, the interrupt for the channel is reset, as well as each device connected to the channel. One at a time, all devices available to this channel are selected and checked for pack change status. The availability status is then updated to release these devices to the other channel.

A selective reset is issued by a system to a single unit that is selected by the system and channel. The selective reset is normally used to reestablish communication with a unit that has an error and is not responding to normal communications.

A selective reset causes the selected drive to be reset, the storage director to reset any interrupt or error condition indications, and the drive to be deselected.

## Channel Command Word

Channel command words (CCWs) in S/370 and in ECPS:VSE mode processors have a similar format. CCWs in Extended Architecture (370-XA) mode operation have two different formats: Format 0 and Format 1. All CCW formats contain the same type of fields, but the fields are arranged in different order. The 3880 supports all CCW formats.

In 370-XA, Format 0 is associated with 24-bit real storage addressing. Format 1 is associated with 31-bit real storage addressing. The CCW formats for S/370 and ECPS:VSE mode are for 24-bit real storage addressing. There is no comparable 31-bit real storage addressing mode for S/370 and ECPS:VSE mode.

The CCW formats are shown in Figure 2-1 on page 2-4.

## Status Information

Status information informs the program of the I/O device status or the conditions under which an I/O operation was ended. See the appropriate Principles of Operation manual (listed in the Preface) for detailed information on status reporting.

### System/370, 370-XA (Format 0), or ECPS:VSE Mode

0	7 8	31 32	39 40	47 48	63
<b>Command Code</b>	<b>Data Address</b>	<b>Flags</b>	<b>Not Used</b>	<b>Count</b>	

### 370-XA Mode (Format 1)

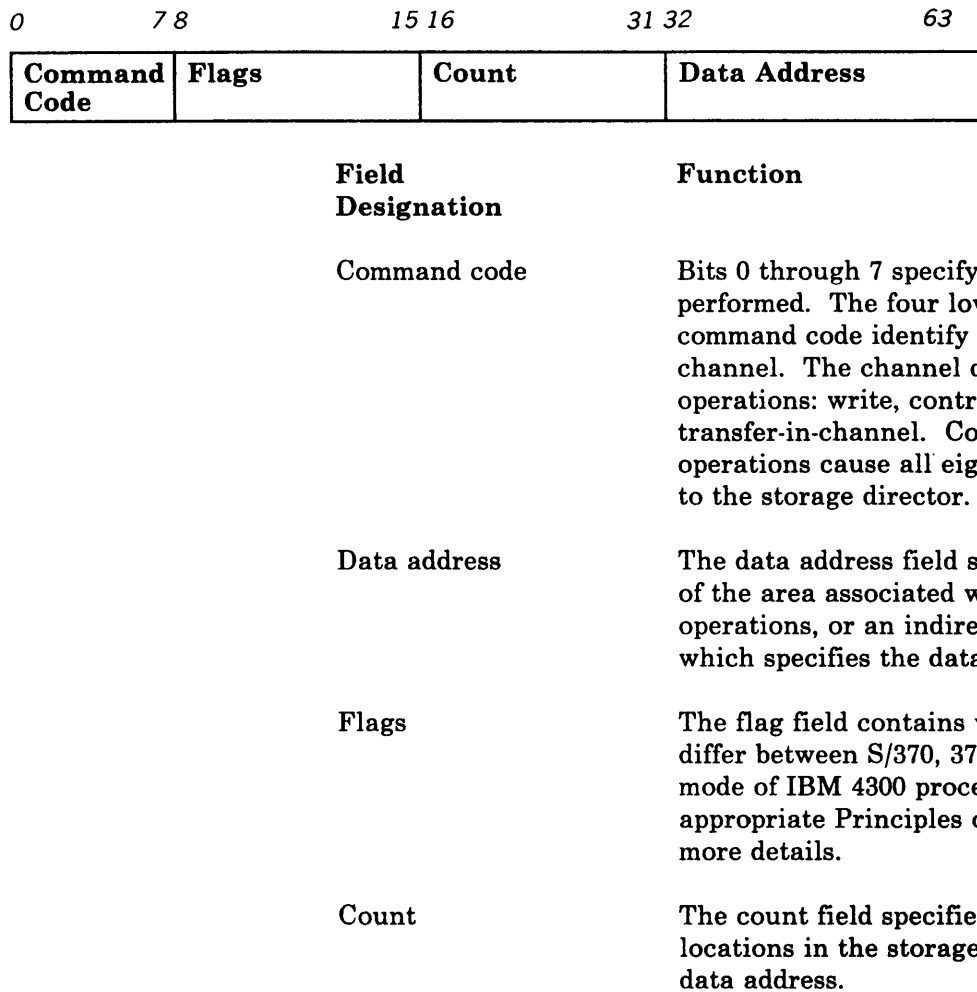

**Figure 2-1. Channel Command Word Formats**



## System/370 and ECPS:VSE Mode

0	31 32	39 40	47 48	63
Command Address	Device Status	Channel Status	Residual Count	

### 370-XA Mode

0	7 8	15 16	31
Device Status	Subchannel Status	Count	

*Note: See the appropriate Principles of Operation manual for more details.*

Field Designation	Function
<b>Channel command</b>	This field usually contains an address eight positions higher than the address word address of the last CCW used.
<b>Device Status</b>	
Attention	Attention is set with device end and unit exception to indicate a not ready to ready transition (3375 and 3380).
Status modifier	Status modifier is set whenever a Search High, Search Equal, or a Search High or Equal command has been executed and the condition was satisfied (CKD command set only).  The status modifier is also set, along with the busy bit, to signify that the storage director is busy.  It is also set with channel end and unit check to initiate command retry.
Control unit end	Control unit end is set if a storage director busy status has been generated previously and the busy condition has been terminated.
Busy	Busy indicates that the selected device is busy.  (For 3380 Models AA4, A04, and B04, it also indicates that CE Mode is set.)  It also is set in response to any command (except Test I/O) if there is outstanding status for the device.

Channel end	Channel end is set at the end of data transfer for each channel command.
Device end	Device end is set at the end of device activity for each channel command.  When device end is set without other status bits, it indicates that the device is available. It is also set with channel end after successful completion of all commands not requiring access motion or media positioning.  When set with attention and unit exception, it indicates a not ready to ready transition (3375 and 3380 only).
Unit check	Unit check is set whenever an unusual or error condition is detected. A sense I/O command may then be used to identify the condition.  It also is set with status modifier and channel end to indicate command retry.
Unit exception	Unit exception is set with channel end and device end to indicate that the trace/dump buffer is not valid during execution of a Diagnostic Sense/Read command. Unit exception also is set during a Write Key and Data and Write Data commands.  For CKD, it indicates an end of file has been detected during a Read R0, Read IPL, Read CKD, Read Key and Data, Read Data, Write Update Key and Data, Write Key and Data, Write Data or a Write Update Data command. It results from a data length of zero being detected in the count area of a record. When this condition is detected, no data is transferred to or from the data area. If the key length is not zero, the key area is transferred.  Set with attention and device end to indicate a not ready to ready transition (3375 and 3380).
Channel status	The channel status field indicates channel conditions. For 370-XA mode, this field contains the subchannel status.
Residual count	This field contains the residual count from the last CCW used.
(S/370, ECPS:VSE)	
Count (370/XA)	

## Program Status Word

When an I/O interrupt occurs, the current program status word is stored, and a new program status word is loaded. By storing the current PSW during an interruption, processor status is preserved for inspection by the program. Loading a new PSW causes the state of the processor to be initialized or changed to branch to a new instruction sequence. If, at the end of an interrupt routine, an instruction is executed that restores the old PSW as the new PSW, the system is restored to the state existing before the interruption, and the interrupted routine continues.

A detailed description of the program status word can be found in the appropriate publication listed at the beginning of this chapter.

## Status Presentation

### Initial Status

The initial status byte is zero for Test I/O commands and all non-immediate commands unless one or more of the following conditions exists.

- Control unit busy is indicated for one of the following reasons:

A write operation is still in progress after chaining has been terminated.

The storage director is disconnected during command chaining when a storage control error recovery procedure is in progress.

The storage director is doing a format defective block, check data, or format ID operation. (See the Channel Commands section for a description of the Locate, Write, or Diagnostic Control commands.)

The storage director is executing a Diagnostic Load command or a diagnostic test.

A status condition is pending in the storage director for other than the addressed device. (See the Pending Status section of this manual.)

A system reset is in progress.

The storage director is maintaining a contingent connection to some device other than the addressed device. (See the Contingent Connection section of this manual.)

A storage director initiated connection is preferred over a channel initiated connection because presentation of consecutive device busy or zero status to the channel exceeds the number of devices that can be attached to the storage director.

The storage director is in a long connection with another channel.

The storage director is initiating a seek operation after having disconnected from the channel.

The storage director is accumulating sense data for a previously presented unit check and a command is received for the device in the contingent connection.

- A status condition is pending in the storage director. (See the Pending Status section of this manual.) The pending status is presented as initial status and the busy bit is included in the status byte unless a Test I/O command was being executed. The busy bit indicates that the device is busy because of the outstanding status. The pending status is then cleared unless it is stacked by the channel. After the status is cleared, the device must be readdressed to determine whether it is available.
- The device is busy to the channel interface. In this case, the busy bit appears alone in the initial status byte. The device is busy to the interface if channel end occurred without device end for the device, and device end has not been generated, or if the device is reserved by another interface. This paragraph does not apply to Set Path Group ID and Sense Path Group ID commands addressed to 3380s with the dynamic path selection function.
- A status condition is pending in the device. (See the Pending Status section of this manual.) The pending status is presented as initial status and the busy bit is included in the status byte unless a Test I/O command was being executed. The pending status is then cleared unless it is stacked by the channel. This paragraph does not apply to Set Path Group ID and Sense Path Group ID commands addressed to 3380s with the dynamic path selection function.
- A unit check condition exists at the storage director or device. In this case, unit check is presented as initial status unless the command was a Sense command. A zero initial status byte is presented for the Sense command if the Sense command is issued while in a contingent connection.
- Initial status indicates command retry.
- Invalid parity is sensed in the command code.

Immediate commands (commands not requiring data transfer) present channel end and device end in initial status.

## Pending Status

A pending status condition can exist for either the storage director or a device. Status is pending for the storage director if:

- Interface disconnect was signaled after a command was issued but before channel end status was accepted. The ending status for the operation is pending after the operation is complete.
- Interface disconnect was signaled during a Test I/O command before the status was accepted by the channel. The status for the addressed device remains pending in the storage director.
- Busy, channel end, or unit check status was stacked by the channel.
- Zero status in response to a Test I/O command was stacked by the channel.
- Control unit busy status was presented to the channel. (Control unit end is pending.)
- Device end status from a Locate or Diagnostic Control command is stacked.

*Note: If device end status for a not ready to ready interrupt is stacked in a multichannel environment, the status is pending in the storage director, but the storage director does not appear busy for all other devices.*

Status pending for the storage director (except for control unit end) causes the storage director to appear busy for all devices except the device for which the status condition exists. Unless it is busy, the storage director will request service to clear the pending status. Status is cleared when presented to, and accepted by, the channel.

Status is pending for a device if:

- Channel end was presented alone and the operation is complete at the device.
- Busy status was presented and the device is no longer busy.
- The device has gone from a not ready status to a ready status.
- Device end status from a Seek or Set Sector command is stacked.

Status pending for a device causes the storage director to request service when both the storage director and device are not busy. The status is cleared when presented to, and accepted by, the channel.

Device end status is the only condition that can be pending in a device.

## Status Pending Indicator

The Status Pending indicator on the operator panel is on when:

- The storage director is in a contingent connection state.
- The storage director is waiting for a device response during a storage director and/or device retry.
- Status is pending for the storage director.

## Priority of Pending Status Conditions

When presented via polling, the priority of pending status conditions is:

- Status pending in the storage control (except control unit end)
- Unsuppressible status
- Suppressible device end status
- Control unit end status.

*Note: During a contingent connection, control unit end has first priority.*

## Address Associated with Pending Status

All status conditions (except control unit end) are associated with a specific device address. When there is no contingent connection, control unit end may be cleared by addressing any of the devices attached to the storage director. However, during a contingent connection, control unit end is associated with the specific address for which the contingent connection is being maintained.

When presented via polling, the address associated with control unit end status is always the lowest device address within the range of addresses recognized by that storage director, whether the device exists or not.

*Note: Generally, when all the device addresses within a specified address range on a storage director do not exist, the system control program (SCP) I/O generation may not include the non-existent device addresses. The handling of control unit end status, which may be accompanied by the address of a non-existent device on the storage director, is SCP dependent.*

*For the MVS/SP Version 1 SCP (MVS/370), control unit end status is handled much the same as a channel available interrupt. In the redrive of any I/O requests queued by IOS, only the channel portion of a device address accompanying the control unit end status is used; the control unit/device portion of the address is ignored. For MVS/SP Version 2 (MVS/XA), all redrive of queued operations after receipt of control unit end status is handled by the channel subsystem, not the SCP.*

*Under both of these SCPs, the IOCP CNTLUNIT macro must include the full range of addresses the control unit is capable of responding to, whether all the devices are physically installed or not. The MVS/370 or MVS/XA SYSGEN need include only the actual devices installed on the control unit.*

*When other SCPs receives status (like control unit end) from a non-existent device, the status may be ignored. For the 3880 attached to non-MVS systems, the lowest non-existent address should be generated to ensure that the SCP will recognize the address returned with control unit end status. Likewise, addresses for devices to be added to a system should be generated before they are actually installed.*

## **Suppressible Status**

All status conditions are suppressible except (1) device end status associated with channel end for which chaining has been indicated and (2) the device end status associated with unchained Locate or Diagnostic Control commands.

## **Contingent Connection**

A contingent connection is established in the storage director after the channel accepts a status byte containing unit check. It lasts until a command other than Test I/O or No-Operation receives an initial status byte of zero for the storage director and device address that generated the unit check, or a selective or system reset occurs.

## **Addressing**

Each storage director and drive (or access mechanism, if applicable) is assigned a device address at the time of installation. This address (8 bits) is used by the channel to select a particular device. See Appendix A for a detailed description of device addressing.

The selection tag is propagated if an attempt is made to address a storage director, controller, or string that is non-existent, powered off, or disabled by the channel Enable/Disable switch on the 3880 panel or by the string switch feature. The 3880 presents unit check if that controller has been selected successfully since the last IML.

When the 3880 and its attached devices are separately powered on and enabled to an already running operating system, operator commands may need to be issued after the 3880 is made available to ensure that all device addresses are recognized. (See the operating system operators guide for the appropriate commands.)

If an addressed drive in a properly selected string or controller is non-existent or powered off, unit check is presented in the initial status.

## Channel Commands

The 3880 supports two different channel command sets: one for devices using a count, key, and data (CKD) format, and one for devices using a fixed block format. In most cases, the command codes for each command set are different and cannot be used with the other command set.

There are eight basic types of commands: control, write, read, search, sense, test I/O, diagnostic, and transfer-in-channel. The following is a brief description of the basic types of commands. Individual commands for each command set are described in detail in the Fixed Block Command Set and Count, Key, and Data Command Set sections of this manual.

### Control

Control commands do not involve a transfer of data records between the storage director and main storage. However, control information is often transferred from main storage to the storage director. This information may include an order code specifying some further action to be taken by the storage director or device, or it may contain parameters defining the types of operations that are allowed or data areas which may be accessed.

The data address field of the channel command word or indirect address word (ECPS:VSE excepted) designates the location containing the required additional information.

### Write

Write commands transfer data from main storage to disk storage. Data is fetched from main storage in an ascending order of addresses, starting with the address specified in the data address field of the channel command word or indirect address word (ECPS:VSE excepted).

### Read

Read commands transfer data from disk storage to main storage. Data is placed in main storage in an ascending order of addresses, starting with the address specified in the data address field of the channel command word or indirect address word (ECPS:VSE excepted).

When using the count, key, and data command set, some read commands can operate in either single-track or multitrack mode. These commands are identified in the individual command descriptions in the Count, Key, and Data Command Set section of this manual.



## Search

The search commands are part of the count, key, and data command set. During execution of search commands, the channel operates in write mode while the disk storage operates in read mode. The storage director compares the data coming from the drive against the data from main storage. When the search has been satisfied (for example, compared equal, high, and so on), the storage director returns a status modifier bit with channel end and device end. This causes the channel to skip the next CCW in the chain and fetch the next CCW from a storage location 16 bytes higher than the current CCW. Normally a Transfer-in-Channel (TIC) command is chained to the search command. The following is an example of this procedure:

```
Search Key Equal
TIC *-8
Read Data
```

When the search is unsuccessful, the TIC command following the search command causes the search to be repeated. When the search is successful, the status modifier causes the TIC command to be skipped and the Read Data command to be executed.

## Sense

The Sense command transfers up to 24 bytes of basic sense information from the storage director to the channel. These 24 bytes provide information about unusual conditions detected in the last operation and the current status of the storage director and device. The Sense ID command transfers up to seven bytes of information that define the DASD configuration.

Other sense-type commands perform other functions (such as reserving a device) besides transferring the sense information, device characteristics, or log and statistical data.

## Test I/O

The Test I/O command is not the result of the channel executing a CCW and it is not written into the channel program by the programmer.

The Test I/O command is automatically generated by the channel when the channel requires status information. It appears to the storage director as a command byte of all zeros and is treated as an immediate command. Test I/O requests the storage director to send all outstanding status information to the channel. Test I/O normally presents an all-zero status byte. Stacked or pending status (if any) is presented in initial status.

## Diagnostic

The Diagnostic commands are used for maintenance purposes only. Any use other than that provided by IBM diagnostic programs may yield unpredictable results.

## Transfer-in-Channel Command

The Transfer-in-Channel (TIC) command provides chaining capabilities for CCWs not located in adjacent main storage locations. The TIC command does not initiate any I/O operation at the channel, and the storage director and device are not signaled when the command is executed.

Except for 370-XA mode, the TIC command cannot be the first CCW of a channel program. The TIC command cannot transfer directly to another TIC command. To address a TIC command on integral boundaries for double words, the TIC command must contain zeros in the three bits to the extreme right in the data address field. For System/370 and ECPS:VSE mode, the TIC can be stored between 0 to 16 megabytes of real storage. For 370-XA, the TIC can be stored between 0 to 2 gigabytes of real storage.

In System/370 and ECPS:VSE mode, the TIC command code is hexadecimal X'8'C, and the flag and count field is ignored. For 370-XA, the command code is X'08' and the flag and count fields must be zero.

The usual notation for a TIC is: TIC \*-8. This notation indicates that the TIC is a branch to the present CCW address minus eight.

The following table summarizes the main differences of a TIC command between System/370, ECPS:VSE, and 370-XA (Format 0) modes and 370-XA (Format 1) mode.

	<b>System/370, ECPS:VSE, and 370-XA (Format 0)</b>	<b>370-XA (Format 1)</b>
Command code	X'8'	'08'
Count	Cannot be 0	Must be 0
Stored address	0-16 megabytes	0-2 gigabytes
Field format	Flags and count ignored	Flags and count must be 0
First CCW	Cannot be TIC	TIC allowed

## Chapter 3. Fixed Block Command Set

Figure 3-1 is a summary of the fixed block command set used for 3370 operation. This section of the manual also contains a detailed description of each command. For illustration purposes, the CCW format associated with System/370 mode, ECPS:VSE mode, and 370-XA (Format 0) mode is shown in the command examples.

Command	Page	Hexadecimal	Binary
<b>Control</b>			
No-Operation (No-Op)	3-2	X'03'	0000 0011
Define Extent	3-3	X'63'	0110 0011
Locate	3-6	X'43'	0100 0011
<b>Read</b>			
Read	3-10	X'42'	0100 0010
Initial Program Load (IPL)	3-12	X'02'	0000 0010
<b>Write</b>			
Write	3-13	X'41'	0100 0001
<b>Sense</b>			
Sense	3-16	X'04'	0000 0100
Sense Identification (ID)	3-17	X'E4'	1110 0100
Read and Reset Buffered Log	3-18	X'A4'	1010 0100
Read Device Characteristics	3-19	X'64'	0110 0100
Device Reserve	3-21	X'B4'	1011 0100
Device Release	3-22	X'94'	1001 0100
Unconditional Reserve	3-23	X'14'	0001 0100
<b>Diagnostic</b>			
Diagnostic Control	3-25	X'F3'	1111 0011
Diagnostic Sense/Read	3-30	X'C4'	100 0100

Figure 3-1. Summary of the Fixed Block Command Set

# No-Operation

Command Code	Data Address	Flags	Not Used	Count (Decimal)
0000 0011 X'03'	Ignored	Used at the discretion of the programmer		Must be nonzero to avoid program check

## Function

The No-Operation (No-Op) command is used to maintain channel connection during I/O operations.

## Chaining Requirements

None.

## Status

Channel end and device end are presented in initial status.

## Description

The No-Op command is processed as an immediate command. It causes no action at the addressed device. Channel end is signaled immediately upon receipt of the command code.

# Define Extent

0	7 8	31 32	39 40	47 48	63
Command Code	Data Address	Flags	Not Used	Count (Decimal)	
0110 0011 X'63'	Specifies the main storage location of the first byte of parameters	Used at the discretion of the programmer		16	

## Function

The Define Extent command transfers 16 bytes of parameters from the channel to the storage director. The parameters define the size and location of a data extent.

## Chaining Requirements

The Define Extent command must not be preceded by another Define Extent or Read IPL command in the same chain.

## Status

Initial status is normally zero. Channel end and device end are presented after the parameters have been transferred and checked for validity. Invalid parameters cause the command to be terminated with channel end, device end, and unit check status.

## Description

The data extent area, defined by the parameters transferred to the storage director, establishes limits on the device within which subsequent chained commands are permitted to operate. The parameter list also contains an inhibit mask to determine which types of commands are permitted in the chain.

The format of the parameters transferred is:

Byte	Description
0	Mask byte
1	Must be zero
2 and 3	Block size
4 through 7	Offset to first block of extent
8 through 11	Relative displacement, in the data set, to the first block of the extent
12 through 15	Relative displacement, in the data set, to the last block of the extent

The Define Extent command parameters are retained in the storage director until the end of the command chain.

## Byte 0

This byte is the mask byte. It is used to inhibit or control certain operations in subsequent commands in the chain. The function of the bits is:

Bits	Function
0 and 1	
00	Inhibits format write operations
01	Inhibits all write operations
10	Must not be used
11	Permits all write operations
2 and 3	Must be 00 or parameters are invalid
4	
0	Data area
1	CE area. Used for maintenance purposes only
5	
0	Inhibit diagnostic commands
1	Permit diagnostic commands
6 and 7	Must be 00 or parameters are invalid

## Byte 1

This byte is not used, but it must be set to zero or the parameters are invalid.

## Bytes 2 and 3

These bytes define the block size and should be set to a value of 512. (A value of zero in these bytes is interpreted as a default value of 512.)

## Bytes 4 through 7

These bytes define the offset, in blocks, from the beginning of the device to the first block of the extent.

## Bytes 8 through 11

These bytes define the relative displacement, in blocks, from the beginning of the data set to the first block of the extent.

**Bytes 12 through 15**

These bytes define the relative displacement, in blocks, from the beginning of the data set to the last block of the extent.

*Note: The storage director uses the offset parameters to determine if the extent of the data set is within the limits of the addressed device. If the limit is exceeded, the Define Extent command parameters are invalid and the command is terminated with channel end, device end, and unit check status.*

The following example illustrates the use of bytes 4 through 15 in the Define Extent command. This is a data set consisting of three extents recorded on two logical devices. For example, if bytes 4 through 15 = X'00 00 02 08 00 00 00 64 00 00 00 95',

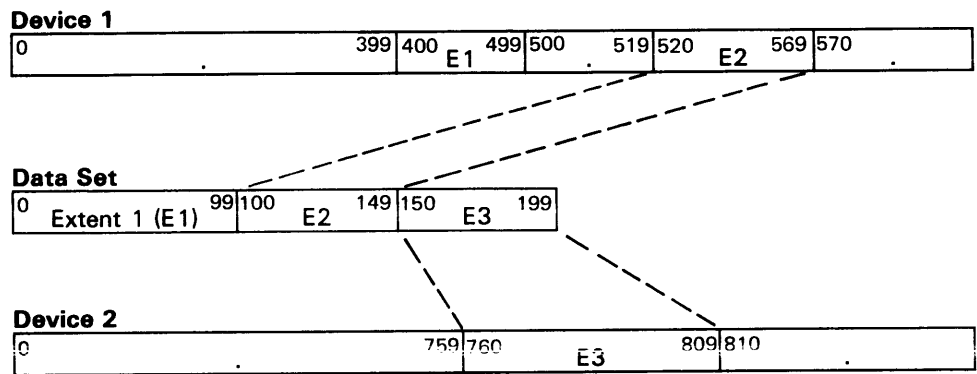

In the example, the Define Extent command is used to specify the second extent area of the data set. The limits of the extent are defined by the two displacements relative to the beginning of the data set (blocks 100<sub>10</sub> and 149<sub>10</sub>). The location of the extent on the device is specified by an offset from the beginning of the device (block 520<sub>10</sub>).

A subsequent Locate command would specify a particular block of data by using a displacement from the beginning of the data set. A valid parameter in the Locate command for this example would be in the range from block (100<sub>10</sub> to block 149<sub>10</sub>).

# Locate

Command Code	Data Address	Flags	Not Used	Count (Decimal)
0100 0011 X'43'	Specifies the main storage location of the first byte of parameters	Used at the discretion of the programmer		8

## Function

The Locate command transfers eight bytes of parameters from the channel to the storage director. The parameters specify the location and amount of the data to be processed.

## Chaining Requirements

The Locate command must be preceded by a Read IPL or Define Extent command in the same chain or the command is rejected with channel end, device end, and unit check status.

## Status

Initial status is normally zero. Channel end is presented after the parameters have been transferred and checked for validity. See the following description for conditions causing command termination and status associated with the termination.

## Description

The parameters transferred by this command have the following format:

Byte	Description
0	Operation byte
1	Auxiliary byte
2 and 3	Number of blocks to be transferred
4 through 7	Relative displacement of the first data block in the data set

## Byte 0

Byte 0 is the operation byte. It specifies the type of record orientation that is required, and the operation to be performed when the desired track position is reached. Byte 0 consists of two functional parts; bits 0 through 3 are modifier bits, and bits 4 through 7 define the operation code.

**Modifier Bits (0 through 3).** The modifier bits are not used for 3880/3370 operations. Bits 0, 1, and 2 are reserved and must be set to zero; otherwise the parameters are invalid and the command will terminate with device end and unit check status. Bit 3 is not used.



**Operation Code Bits (4 through 7).** These four bits define the following operations:

<b>Bits 4-7</b>	<b>Operation</b>
0100	Format defective block
0001	Write data
0101	Write and check data
0010	Read replicated data
0110	Read

Any other combination of bit settings is invalid and will cause the command to terminate with device end and unit check status.

Data transfer between the channel and storage director associated with these operations does not occur during execution of the Locate command. Data transfer is initiated by a read or write CCW following the Locate command.

*Format Defective Block (0100):* This operation code causes the storage director to flag the block specified by bytes 4 through 7 as defective. The storage director assigns an alternate block and establishes the appropriate backward and forward pointers.

If the mask specified in the Define Extent command inhibits format write operations, or if the Write Inhibit switch on the device is in the read-only mode, the Locate command is terminated with device end and unit check status.

Upon receipt of the format defective-block operation code, the storage director initiates an access to the first alternate block on the same physical cylinder as the defective block. The storage director then scans for the first unused alternate block. If there is not enough space in the alternate area of the same physical cylinder, the storage director initiates an access to the alternate area of the nearest physical cylinder and continues scanning. This process is repeated until an unused alternate block is found, or until all alternate space on the device has been scanned. If all alternate space has been used, the storage director signals unit check and device end status.

If an unused alternate block is located, the storage director saves the alternate block pointer and initiates an access to the defective block specified in bytes 4 through 7 of the parameters, verifies correct orientation, and formats the block identification (ID) with the defective flag bit on and the appropriate block pointer.

Format defective block operates on a single block only. Future references to the defective block cause the storage control to access the assigned alternate block.

There is no data transfer between the channel and storage control during the format defective block operation. All write data is generated internally by the storage control. Only the ID areas of the defective and alternate blocks are written. A Locate command specifying write data should be issued after the format defective block to write the data field of the block.

If the Locate command was preceded by a Diagnostic Control command with a subcommand of Displace ID, the storage director writes the block ID in its normal, displaced, or extended displaced position according to the Displace ID subcommand. The storage director then performs a read-back check on the block ID just written. If it is unreadable due to the data errors, the operation is terminated with device end and unit check status.

If the Locate was not preceded by a Diagnostic Control command, the storage director writes the block ID in its normal position and performs a read-back check on the block ID. If it is unreadable due to data errors, the storage director rewrites the block ID at a displaced position and performs another read-back check. If the ID is still unreadable, the storage director rewrites the block ID at an extended-displaced position and performs another read-back check. If the data is still unreadable, the operation is terminated with device end and unit check status.

In either case (with or without a preceding Diagnostic Control command) if the read-back check is successful, the storage director initiates an access to the alternate block, verifies proper orientation, formats the alternate block ID with the appropriate flag byte and backward pointer, and presents device end status.

*Write Data (0001):* This operation code prepares the storage director to write one or more blocks of data. The number of blocks to be written is specified in the block count parameters of the Locate command (bytes 2 and 3). If the mask specified in the Define Extent command inhibits all write operations, or if the Write Inhibit switch on the device is in the read-only mode, the Locate command is terminated with device end and unit check status.

The write data operation establishes write orientation in the storage director for the addressed device.

Write data causes the storage control to initiate an access to the first block to be processed. The relative displacement of the first block specified by bytes 4 through 7 of the parameters is converted to the appropriate physical values for the addressed device. When the access to the block is complete, the device presents device end status.

*Write and Check Data (0101):* The storage director performs the same functions as described for the write data operation code and, in addition, performs a read back check on the data just written.

*Read Replicated Data (0010):* This operation code prepares the storage director to read one or more blocks of data from a range of replicated data. The number of blocks to be read is specified in the block count parameters (bytes 2 and 3). This operation establishes read orientation in the storage director for the addressed device.

Read replicated data causes the storage director to initiate an access to the first block of any unit of replicated data. Device end status is presented when the access is complete.

*Read Data (0110)*: This operation code prepares the storage director to read one or more blocks of data. The number of blocks to be read is specified in the block count parameters (bytes 2 and 3).

Read data causes the storage director to initiate an access to the first block of data to be processed. The relative displacement of the first block specified by bytes 4 through 7 of the parameters is converted to the appropriate physical values for the addressed device. Device end is presented when the access is complete.

### **Byte 1**

Byte 1 is the replication count. This byte is ignored if byte 0 specifies a format defective block. Byte 1 must be zero if byte 0 specifies read, write, or write and check data. When byte 0 specifies read replicated data (bits 4 through 7 = 0010), byte 1 specifies a range of blocks containing replicated data. The first block of this range is specified by the relative displacement in bytes 4 through 7 of the parameters.

The storage director orients to the beginning of a unit of replicated data to minimize rotational delay.

The block count (bytes 2 and 3 of the parameters) specifies the number of blocks in a unit of replicated data. For example, if the block count is two and this two-block unit is replicated five times, the replication count is ten.

If the replication count is less than the block count, or if the replication count is not a multiple of the block count, the Locate command is terminated with device end and unit check status.

If the replicated count equals the block count, the storage director converts the read replicated data operation to a read data operation.

### **Bytes 2 and 3**

Bytes 2 and 3 are the block count parameters. They specify the number of sequential blocks (maximum of 65,535) to be processed by the command immediately following the Locate command. These bytes must not be zero or the Locate command terminates with device end and unit check.

### **Bytes 4 through 7**

Bytes 4 through 7 specify the relative displacement, in blocks, from the beginning of the data set to the first block to be processed. The storage director compares the relative block displacement of the blocks to be processed and the replication count (byte 1) against the logical extent limits established by the previously executed Define Extent command.

If the blocks to be processed are within the valid extent, the storage director processes the Locate command. If any block is not within the valid extent range, the Locate command is terminated with device end and unit check status.

# Read

0	7 8	31 32	39 40	47 48	63
Command Code	Data Address	Flags	Not Used	Count (Decimal)	
0100 0010 X'42'	Specifies the main storage location where the first byte of data is to be transferred	Used at the discretion of the programmer		Specifies the number of bytes to be read	

## Function

The Read command causes data to be transferred from a device to the channel.

## Chaining Requirements

The Read command must be chained from a Locate command or the command is rejected with channel end, device end, and unit check status.

## Status

Initial status is normally zero. Channel end and device end are presented after the data is transferred to the channel. See the following description for conditions causing command termination and status associated with the termination.

## Description

Upon receipt of the Read command, the storage director reads the block ID and verifies correct orientation.

*Note: If a Read command is chained from a Locate command and the storage director is not read oriented for this device, the Read command is terminated with channel end, device end, and unit check status. See the description of the Locate command for additional information regarding read orientation.*

After verification of orientation, the following 512-byte data block is read and transferred to the channel. This process is repeated until the block count specified in the preceding Locate command reaches zero. If the CCW count is greater than the byte count derived from the block count specified in the Locate command, data transfer stops when the block count reaches zero. If the CCW count is less than the byte count derived from the block count specified in the Locate command, data transfer stops when the CCW count reaches zero, but the storage director continues to read data until the block count reaches zero.

If a command overrun occurs on a Read CCW, the storage director signals retry status (channel end with status modifier and unit check) and disconnects. After re-orientation to the block, the storage director reconnects and continues the operation.

Command overrun may occur because of late channel reconnection on a record ready condition.

If a service overrun occurs while reading a block of data (other than the first block), the storage director terminates the operation with retry status. Channel end, device end, and unit check status is then presented on the retried Read CCW.

If the service overrun is in the first block, the storage director attempts recovery with command retry. If retry is unsuccessful, the storage director terminates the command with channel end, device end, and unit check status.

If a data error is detected while reading a block ID, the storage director attempts recovery with internal retry. After re-orientation to the block, the storage director continues the operation. If retry is unsuccessful, the storage director terminates the command with channel end, device end, and unit check status.

If a correctable data error is detected while reading a data block, the command is terminated with retry status. Channel end, device end, and unit check status are then presented on the retried Read CCW. The sense data contains the data check and correctable bits along with the correction pattern bytes and displacement of the error so that the system error recovery procedures can correct the error. If the correctable error did not occur in the last data block for this CCW, operation incomplete is also set.

If an uncorrectable data error is detected in any data block except the first, the storage director terminates the command with retry status. Unit check status is then presented on the retried Read CCW. If the uncorrectable error is in the first block, the storage director attempts recovery with command retry. If retry is unsuccessful, the command is terminated with channel end, device end, and unit check status.

An access error may occur on the Read CCW because of an access movement initiated by the storage director when an access boundary is encountered during a multiple block transfer or when a defective block is encountered. If an access error is detected before data transfer is initiated, the storage director attempts recovery with command retry. If retry is unsuccessful, the command is terminated with channel end, device end, and unit check status. If the access error is detected after data transfer has been initiated, the command is terminated with channel end, device end, and unit check status.

# Read Initial Program Load

Command Code	Data Address	Flags	Not Used	Count (Decimal)
0000 0010 X'02'	Specifies the main storage location where the first byte of data is to be transferred	Used at the discretion of the programmer		Specifies the number of bytes to be transferred

## Function

The Read Initial Program Load (IPL) command causes the storage director to orient to and then read block 0.

## Chaining Requirements

The Read IPL command must be the first command in a chain or must be chained from another Read IPL command or the command is rejected with channel end, device end, and unit check status.

## Status

Initial status is normally zero. Channel end and device end are presented after the data has been transferred to the channel.

## Description

Upon receipt of the Read IPL command, the storage director establishes an extent of maximum allowable size with an offset of zero, a mask byte of zero, and an addressable block size of 512. The storage director then orients to block zero and reads the entire block.

The Read IPL command will not transfer more than 512 bytes or transfer data from any block other than block 0.

If a service overrun occurs while reading block 0, the storage director attempts recovery with command retry. If retry is unsuccessful, the storage director presents channel end, device end, and unit check status.

If a data check is detected in the block ID, the storage director attempts recovery with internal retry. If retry is unsuccessful, the storage director presents channel end, device end, and unit check status.

If a correctable data check is detected in the data block, the storage director terminates the operation with retry status. Channel end, device end, and unit check status are then presented on the retried Read IPL CCW. The sense data contains the data check and correctable bits along with the correction pattern byte and error displacement.

If an uncorrectable data check is detected in the data block, the storage director attempts recovery with command retry. If retry is unsuccessful, the storage director presents channel end, device end, and unit check status.

# Write

0                    7 8                                    31 32                                    39 40                                    47 48                                    63

Command Code	Data Address	Flags	Not Used	Count (Decimal)
0100 0001 X'41'	Specifies the main storage location of the data to be written	Used at the discretion of the programmer		Specifies the number of bytes to be written

## Function

The Write command causes data to be transferred from the channel to the storage director.

## Chaining Requirements

The Write command must be chained from a Locate command or the command is rejected with channel end, device end, and unit check status.

## Status

Initial status is normally zero. If write data is specified in the operation byte of the preceding Locate command, channel end and device end are presented by the storage director after data transfer has been completed. See the following description for status presentation when write and check data is specified.

## Description

Upon receipt of the Write command, the storage director reads the block ID and verifies correct orientation.

*Note: If the Write command is chained from a Locate command and the storage director is not write oriented for this device, the command is rejected with channel end, device end, and unit check status. See the description of the Locate command for additional information regarding write orientation.*

After verification of orientation, the following data block is written with data transferred from the channel. This process is repeated until the block count specified in the previous Locate command reaches zero.

If the CCW count is greater than the byte count derived from the block count specified in the Locate command, data transfer stops when the block count reaches zero. If the CCW count is less than the byte count derived from the Locate command, data transfer stops when the CCW count reaches zero, but the storage director continues to write zeros in the data blocks until the block count reaches zero.

If access boundaries are encountered during data transfer, the storage director performs the appropriate access movement.

If write and check data is specified in the preceding Locate command, the storage director re-initializes the block count and initiates an access back to the first block and presents channel end status. When the access is complete, the storage director reads the block ID and verifies correct positioning. The following data blocks are then read by the storage director, but the data is not transferred to the channel. After all blocks are read (block count equals zero), the storage director presents device end status.

If a command overrun occurs on a Write CCW, the storage director signals retry status and disconnects from the channel. After re-orientation to the block, the storage director reconnects and continues the operation. (Command overrun may occur because of late channel reconnection on a record ready interrupt.)

If a service overrun occurs while writing a data block (other than the first block) when write data is specified in the preceding Locate command, the storage director terminates the command at the end of the data block with retry status (channel or device end with status modifier and unit check). Channel end, device end, and unit check status are then posted on the retried Write CCW.

If the service overrun occurs in the first block when write data is specified, or in any block when write and check data is specified, the storage director attempts recovery with command retry. If the retry is unsuccessful, the command is terminated with channel end, device end, and unit check status.

If a data error is detected while reading a block ID to verify correct orientation, the storage director attempts recovery with internal retry. After re-orientation to the block, the storage director continues the operation. If retry is unsuccessful, the command is terminated with channel end, device end, and unit check status.

If an uncorrectable data error is detected while reading a data block during an write- and check-data operation, the storage director terminates the operation and presents unit check status. Sense data indicates a check data error.

If a correctable data error is detected in a data block during a write- and check-data operation, the storage director continues the operation until the block count reaches zero. An access error may occur on the Write CCW as a result of an access movement initiated by the storage director when an access boundary is encountered during a multiple block transfer or when a defective block is encountered. If the access error occurs on a Write command with write data specified in the preceding Locate command, the storage director attempts recovery with command retry if the error occurred before data transfer or terminates the command with channel end, device end, and unit check status if the error was detected during data transfer.

If the access error is detected on a Write command with write and check data specified, the storage director attempts recovery with command retry.



If retry is unsuccessful, the command is terminated with channel end, device end, and unit check status.

If the access error is detected during the read-back check operation, the storage director uses internal retry for recovery. If recovery is unsuccessful, the storage director terminates the command with device end and unit check status.

*Note: Some software applications post the I/O operation as complete if unit status containing channel end only is stored. As a result, a subsequent device end and unit check may not be made available to the user. This condition can occur if a Write CCW with write- and check-data specified in the preceding Locate command is the last CCW in the chain. Some software applications provide an option to delay posting until device end is received. If such an option is not provided, the user must take special action. A write sequence with verify that would otherwise terminate the chain must be followed by a non-write CCW (such as No-Op).*

# Sense

Command Code	Data Address	Flags	Not Used	Count (Decimal)
0000 0100 X'04'	Specifies the main storage location where the first byte of sense data is to be transferred	Used at the discretion of the programmer		24

## Function

The Sense command (formerly referred to as Sense I/O) transfers 24 bytes of sense information from the storage director to the channel.

## Chaining Requirements

None.

## Status

Initial status is normally zero. Channel end and device end are presented after the sense bytes are transferred.

## Description

The sense information transferred by this command describes the reasons for unit check status, the current status of the device that performed the operation, and system error recovery information.

A unit check should always be followed by a Sense command whether the information is used or not. Otherwise, expected future interrupts may not occur and some I/O access paths may not be available.

A contingent connection state is established in the storage director after the channel accepts a status byte containing unit check. It lasts until a command (other than Test I/O or No-Op) receives an initial status byte of zero for the storage director and device address which generated the unit check. During the contingent connection state, the storage director is busy to all addresses other than the address for which the contingent connection was established.

Sense information is reset to zero after data transfer is complete, or when an initial status byte of zero is given to any command except Test I/O or No-Op.

A Sense command issued during a contingent connection should be a standalone command. This is because much of the device status testing normally performed as part of initial selection is bypassed so that zero initial status can be presented and error information related to the last unit check can be reported. If other commands are chained from the Sense command, the device may not be prepared to execute them, which could result in unpredictable results.

# Sense Identification

0	7 8	31 32	39 40	47 48	63
Command Code	Data Address	Flags	Not Used	Count (Decimal)	
1110 0100 X'E4'	Specifies the main storage location where the first byte of sense data is to be transferred	Used at the discretion of the programmer		7	

## Function

The Sense Identification command (formerly referred to as Sense I/O Type) transfers seven bytes of sense information from the storage director to the channel.

## Chaining Requirements

None.

## Status

Initial status is normally zero. Channel end and device end are presented after the sense bytes are transferred.

## Description

The sense information transferred by this command describes the type and model of the storage control and device being addressed by this command.

The format of the sense bytes is as follows:

### Byte Description

- 0 Always FF
- 1 Storage control type number (38)
- 2 Storage control type number (80)
- 3 Storage control model number (01)  
(01 = 3880 Models 1, 2, and 4)
- 4 Device type number (33)
- 5 Device type number (70)
- 6 Device model number (00 = A1; 04 = A2)

If the device is available and not busy, the Sense ID command is executed even if the device is in the not-ready state.

The sense information is reset after execution of this command.

## Read and Reset Buffered Log

0                    7 8                                    31 32                                    39 40                                    47 48                                    63

Command Code	Data Address	Flags	Not Used	Count (Decimal)
1110 0100 X'A4'	Specifies the main storage location where the first byte of usage and/or error information is to be transferred	Used at the discretion of the programmer		24

### Function

The Read and Reset Buffered Log command transfers up to 24 bytes of usage and/or error information from the storage director to the channel.

### Chaining Requirements

None.

### Status

Initial status is normally zero. Channel end and device end are presented after the usage/error information is transferred.

### Description

The format of the usage/error information transferred to the channel is the same as the 24 bytes of sense information generated after the usage or error counters overflow. (See the Statistical Usage/Error Recording section of this manual.)

The usage/error statistics pertain to the logical device addressed. The statistics are reset to zero after data transfer is complete.

# Read Device Characteristics

0                      7 8                                      31 32                                      39 40                                      47 48                                      63

Command Code	Data Address	Flags	Not Used	Count (Decimal)
0110 0100 X'64'	Specifies the main storage location where the first byte of device characteristics information is to be transferred	Used at the discretion of the programmer		32

## Function

The Read Device Characteristics command transfers up to 32 bytes of device characteristic information from the storage director to the channel.

## Chaining Requirements

None.

## Status

Initial status is normally zero. Channel end and device end are presented after the data has been transferred.

## Description

The information transferred by this command defines the characteristics of the addressed device. The device characteristics have the following format:

Byte	Bits	Description
0		Operation modes
	0	Reserved
	1	Overrunable
	2	On is burst mode and off is byte mode
	3	Data chaining allowed
1	4-7	Reserved
		Features
	0	Reserved
	1	Removable device
	2	Shared device
2	3	Reserved
	4	Movable access mechanism
	5-7	Reserved
2		Device class (X'21')
3		Unit type (X'02' = A1/B1; X'05' = A2/B2)
4, 5		Physical record size (512 bytes)
6, 9		Number of blocks per cyclical group (62)
10-13		Number of blocks per access position (744)

Byte	Bits	Description
14-17		Number of blocks under movable access mechanism (558,000 = A1/B1; 712, 752 = A2/B2)
18-23		Reserved - all zeros
24, 25		Number of blocks in the CE area (1488)
26-31		Reserved - all zeros

If the addressed device is available and not busy but in the not-ready state, the command is not executed. Unit check is presented in initial status.

# Device Reserve

0                      7 8                                      31 32                                      39 40                                      47 48                                      63

Command Code	Data Address	Flags	Not Used	Count (Decimal)
1011 0100 X'B4'	Specifies the main storage location where the first byte of sense data is to be transferred	Used at the discretion of the programmer		24

## Function

The Device Reserve command reserves the addressed device to the channel that issued the command if a channel switch feature is installed in the 3880 or if a string switch feature is installed in the 3370.

## Chaining Requirements

The Device Reserve command must *not* be preceded by a Define Extent or Read IPL command in the same chain.

## Status

Initial status is normally zero. Channel end and device end are presented after up to 24 sense bytes have been transferred.

## Description

Besides reserving the addressed device, the Device Reserve command transfers up to 24 sense bytes to the channel.

A Device Reserve command will be executed regardless of any abnormal device status conditions (such as offline or unsafe).

Device reservation is maintained until the reserving channel successfully completes a Device Release command addressed to the reserved device.

*Note: A system reset cancels reservation of a device to the resetting channel only.*

# Device Release

0	7 8	31 32	39 40	47 48	63
Command Code	Data Address	Flags	Not Used	Count (Decimal)	
1001 0100 X'94'	Specifies the main storage location where the first byte of sense data is to be transferred	Used at the discretion of the programmer		24	

## Function

The Device Release command terminates the reservation of the addressed device from the channel that issued the command if a channel switch feature is installed in the 3880 or if a string switch feature is installed in the 3370.

## Chaining Requirements

The Device Release command must *not* be preceded by a Define Extent or Read IPL command in the same chain.

## Status

Initial status is normally zero. Channel end and device end are presented after up to 24 sense bytes have been transferred.

## Description

Besides terminating the reservation of the addressed device, the Device Release command transfers up to 24 sense bytes to the channel.

A Device Release command will be executed regardless of any abnormal device status conditions (such as offline or unsafe).



# Unconditional Reserve

0	7 8	31 32	39 40	47 48	63
Command Code	Data Address	Flags	Not Used	Count (Decimal)	
0001 0100 X'14'	Specifies the main storage location where the first byte of sense data is to be transferred	Used at the discretion of the programmer		24	

## Function

The Unconditional Reserve command breaks device allocation to the primary (failing) path and establishes allocation to the alternate path in the same system if a channel switch feature is installed in the 3880 or a string switch feature is installed in the 3370.

## Chaining Requirements

The Unconditional Reserve command must be the first command in a chain or the command is rejected with channel end, device end, and unit check status.

## Status

Initial status is normally zero. Channel end and device end are presented after up to 24 sense bytes have been transferred.

## Description

The Unconditional Reserve command is used to recover from hardware malfunctions. It performs all of the functions of the Device Reserve command and, in addition, reserves the device to the alternate path even when the device was reserved or in use through the primary path. Reservation or information in use for the primary path is reset in the device and storage director through which the command was issued. The Unconditional Reserve command does not reset information in the storage director which is now not operational.

Control of the device must be established by the system before the Unconditional Reserve command can be issued. Device control is established if the channel has the device reserved, or the channel has a channel program in progress. If the channel issues an Unconditional Reserve command to a device not assigned to it, one of the following conditions may occur to the other system attached to the string switch.

- If the device is reserved, the reserve is reset and the device becomes reserved to the channel that issued the Unconditional Reserve command.
- An interruption condition will be lost if the device is disconnected between chained commands.

- A recoverable equipment check is presented if the device is active when the command is executed.
- If the device is idle and not reserved, there is no effect.

If the system does not want the device reserved to the alternate path, it must issue a Device Release command. (The Device Release command may be chained to the Unconditional Reserve command.)

The Unconditional Reserve command will be executed regardless of any abnormal device status (such as offline or unsafe) unless the device does not respond to the selection tag or there is a preselection check (indicated by unit check status and equipment check in sense byte 0).

*Note: For configurations that include string switches, execution of an Unconditional Reserve on storage director A and device N can abort an unrelated operation on storage director B and device M.*

# Diagnostic Control

0	7 8	31 32	39 40	47 48	63
Command Code	Data Address	Flags	Not Used	Count (Decimal)	
1111 0011 X'F3'	Specifies the main storage location of the first byte of diagnostic control parameters	Used at the discretion of the programmer		4 + N. See the description below for the value of N.	

## Function

The Diagnostic Control command transfers a minimum of four bytes of diagnostic control parameters from the channel to the storage director.

## Chaining Requirements

The Diagnostic Control command must be preceded by a Define Extent command that allows diagnostics or the command is rejected with channel end, device end, and unit check status.

## Status

Initial status is normally zero. See the following description for ending status presentation.

## Description

The first four bytes of diagnostic control parameters transferred by this command have the following format:

Byte	Description
0	Subcommand identification
1	Subcommand identification modifier bits
2 and 3	Additional number of bytes to be transferred (N)

After the first four bytes have been transferred, the storage director checks the validity of the subcommand identification code and verifies that bytes 2 and 3 specify the correct number of additional bytes required for that subcommand. If an invalid parameter is detected, the Diagnostic Control command is terminated with channel end, device end, and unit check status.

If the parameters are valid, the channel transfers the additional number of bytes (specified in bytes 2 and 3) to the storage director.

If the CCW count is less than  $4 + N$ , the command is terminated with channel end, device end, and unit check status. If the CCW count is greater than  $4 + N$ , only  $4 + N$  bytes are transferred.

## Subcommands

Byte 0 specifies the subcommand to be performed. The following subcommands can be executed by the storage director:

Subcommand	Binary	Hexadecimal
Trace Dump	0000 0000	X'00'
Format ID	0000 0100	X'04'
Space ID and Read Data	0000 0110	X'06'
Read ID	0000 1010	X'0A'
Displace ID	0000 1111	X'0F'

The **Trace/Dump subcommand** is executed to prepare the storage director for a subsequent Diagnostic Sense/Read command that is to transfer the contents of the trace/dump buffer to the channel. The Trace Dump subcommand shown below is used for diagnostic purposes only.

Byte 0	1	2	3
<b>Command Code</b>	<b>Modifiers</b>	<b>Additional Bytes Required</b>	
X'00'	X'00'	X'0000'	

The **Format ID subcommand** can be used for flagging an alternate block as defective, for flagging an alternate block as unused, or for formatting a normal block. Execution of this subcommand (shown below) causes the storage director to rewrite the block ID of the block specified by bytes 8 through 11 of the parameter list. Only one block is affected, and the block count specified in bytes 4 and 5 is ignored.

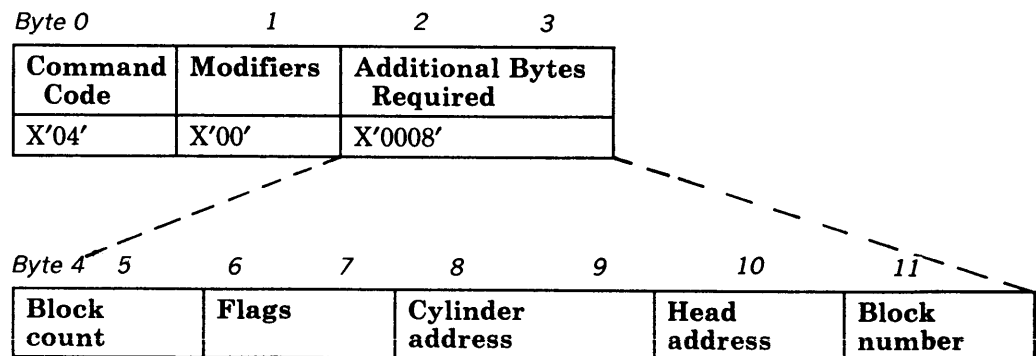

Bit 0 of byte 6 is the alternate area flag bit; bit 1 is the defective-block flag bit; bits 2, 3, and 4 are not used and must be set to zero; and bits 5, 6, and 7 are used as follows:

Bits 5, 6, and 7	Description
000	ID not displaced
001	ID displaced once
010	ID displaced twice

All other combinations are invalid. Byte 7 is not used and must be set to 0. Bytes 8 through 11 contain the physical address and block number.

At the end of data transfer, the storage director checks the parameters for validity. The command is terminated with channel end, device end, and unit check status if any of the following conditions are detected:

- The Define Extent command inhibits format write operations.
- The device is in read-only mode.
- Bytes 8 through 11 contain a physical block address that is invalid for the addressed device.
- The Define Extent command mask byte (byte 0, bit 4) is off and bytes 8 through 11 address a block not in the data area.
- The Define Extent command mask byte (byte 0, bit 4) is on and bytes 8 through 11 address a block not in the CE area.
- The flag byte indicates a prime area (byte 6, bit 0=0) but the addressed block is not in the primary area.
- The flag byte indicates an alternate area (byte 6, bit 0=1) but the addressed block is not in the alternate area.
- Bytes 6 and 7 contain an invalid flag byte.
- The defective-block flag bit (byte 6, bit 1) or one of the displaced ID bytes (byte 6, bit 6 or 7) is on but byte 6, bit 0 does not indicate an alternate area.

If all of the parameters are valid, the storage director initiates an access to the block and presents channel end status. When access to the block is completed, the storage director verifies correct orientation and writes the block ID. (The block ID is internally generated by the storage director.)

If the addressed block is in the alternate area, the alternate flag bit is set in the block ID field. If the defective-block flag bit is on (byte 6, bit 1), the block is flagged as defective with a null alternate/defective pointer and is written at a position indicated by bits 5 through 7 of byte 6. No data field is written for this operation and device end status is presented at the completion of the operation. **The Space ID and Read Data** subcommand can be used to recover the data field of a block when the block ID has a permanent data check. Execution of this subcommand prepares the storage director to space over the block ID field and read the data field of the block specified in bytes 8 through 11 of the parameter list. Only one block is read and the block count in bytes 4 and 5 is ignored.

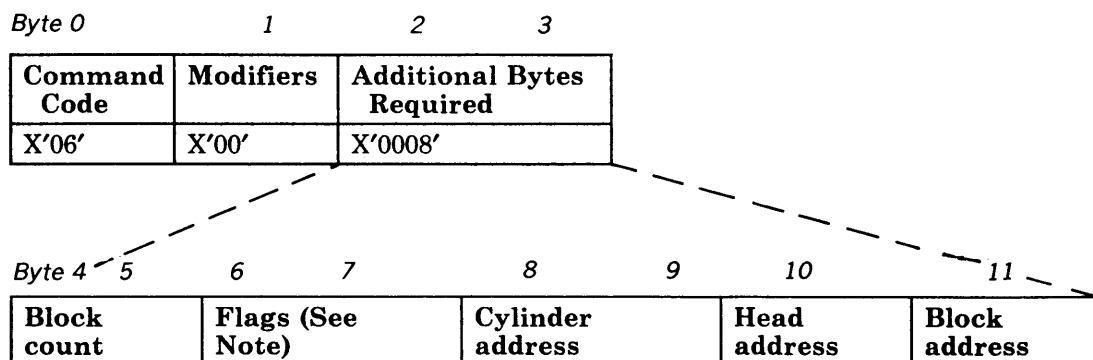

*Note: Bit 0 of byte 6 indicates either prime area (bit off) or alternate area (bit on). All other bits in bytes 6 and 7 are unused and must be zero.*

At the end of data transfer, the storage director checks the parameters for validity. If any of the following conditions are detected, the command is terminated with channel end, device end, and unit check status.

- Bytes 8 through 11 contain a physical address that is invalid for the addressed device.
- The Define Extent command mask byte (byte 0, bit 4) is off and bytes 8 through 11 address a block not in the data area.
- The flag byte (byte 6, bit 0) indicates an alternate area and the addressed block is not in the alternate area, or the flag byte indicates prime area and the block is not in the prime area.
- The Define Extent mask (byte 0, bit 4) is on and bytes 8 through 11 address a block not in the CE area.

If all the parameters are valid, the storage director initiates an access to the block and presents channel end status. When access to the block is completed, device end status is presented.

The actual operation of spacing over the block ID field and transferring the read data is performed by a subsequent Diagnostic Sense/Read command.

**The Read ID subcommand** is used to generate a defective block map for a device. Execution of this subcommand (shown below) prepares the storage director to read one or more block IDs. The number of block IDs to be read is determined by the block count in bytes 4 and 5.

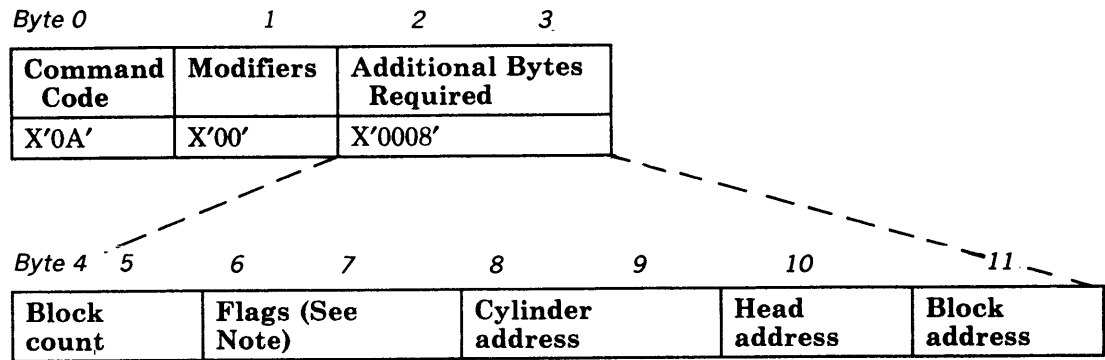

*Note: Bit 0 of byte 6 indicates either prime area (bit off) or alternate area (bit on). All other bits in bytes 6 and 7 are unused and must be zero.*

At the end of data transfer, the storage director checks the parameters for validity. If any of the following conditions are detected, the command is terminated with channel end, device end, and unit check status.

- The blocks specified are not within the limits of the addressed device. (Also, if the flag bit indicates prime area, the block addressed must be in the prime area; and if the flag bit indicates alternate area, the block addressed must be in the alternate area.)
- The Define Extent command mask byte (byte 0, bit 4) is off and bytes 8 through 11 address a block not in the data area.
- The Define Extent command mask byte (byte 0, bit 4) is on and bytes 8 through 11 address a block not in the CE area.

If all the parameters are valid, the storage director initiates an access to the block and presents channel end status. When access to the block is completed, device end status is presented.

The actual operation of reading the block IDs and transferring data to the channel is performed by a subsequent Diagnostic Sense/Read command. The storage director transfers five bytes of data to the channel for each block ID processed. The format of these five bytes is identical to the five bytes of block ID field written on the device. The block IDs processed are logically continuous either in the prime area or in the alternate area.

**The Displace ID subcommand** is executed to prepare the storage director for a subsequent Locate command with an operation code specifying a format defective block. During execution of the format defective block operation, the ID of the defective block is written in the position indicated by the modifier bits in the Displace ID subcommand. The format for the Displace ID subcommand is shown below.

Command Code	Modifiers	Additional Bytes Required
X'0F'		X'0000'

X'10' = Write ID of defective block in normal position.  
X'20' = Write ID of defective block in displaced position.  
X'40' = Write ID of defective block in extended displaced position.



# Diagnostic Sense/Read

0	7 8	31 32	39 40	47 48	63
Command Code	Data Address	Flags	Not Used	Count (Decimal)	
1100 0100 X'C4'	Specifies the main storage location where the first byte of diagnostic information is to be transferred	Used at the discretion of the programmer			See the description below.

## Function

The Diagnostic Sense/Read command transfers diagnostic information from the storage director to the channel. The meaning and number of bytes transferred is determined by the preceding Diagnostic Control command. (See the description below.)

## Chaining Requirements

Must be chained from a Diagnostic Control command or the command is rejected with channel end, device end, and unit check status.

## Status

Initial status is normally zero. See the description below for ending status presentation.

## Description

The data transferred by this command is determined by the subcommands in the preceding Diagnostic Control CCW.

## Trace/Dump Subcommand

The contents of the trace/dump buffer are transferred to the channel. Channel end and device end are presented after data transfer. The trace/dump buffer is normally 4,096<sub>10</sub> bytes.

## Format ID Subcommand

No data transfer takes place on this subcommand. Channel end and device end are presented in ending status.

## Space ID and Read Data Subcommand

After verification of orientation, the storage director spaces over the block ID field of the next block on the same track and transfers the 512-byte data field to the channel. Channel end and device end are presented after data transfer.

## Read ID Subcommand

After verification of orientation, the five-byte block ID field of the following block is read and transferred to a buffer in the storage director. If no ID data errors are detected, the block ID field is transferred from the storage director to the channel.

If an ID error was detected, the storage director attempts recovery with internal retry. This read process continues until the block count reaches zero. If access boundaries are encountered during data transfer, the storage director automatically performs the appropriate access movement. Channel end and device end are presented after data transfer.

If a command overrun occurs, the storage director signals retry status (channel or device end with status modifier and unit check) and disconnects. After re-orientation to the block, the storage director reconnects and continues the operation.

Command overrun may occur because of late channel reconnection on a disconnected command chain.

If a service overrun occurs while reading a block of data (other than the first block), the storage director terminates the operation with retry status. Channel end, device end, and unit check status are then posted on the retried CCW.

If the service overrun occurs in the first block, the storage director attempts recovery with command retry. If retry is unsuccessful, the storage director terminates the command with channel end, device end, and unit check status.

If a data error is detected while reading a block ID, the storage director attempts recovery with internal retry. After re-orientation to the block, the storage director continues the operation. If retry is unsuccessful, the storage director terminates the command with channel end, device end, and unit check status.

If a correctable data error is detected while reading a data block, the command is terminated with channel end, device end, and unit check status. The sense data contains the data check and correctable bits along with the correction pattern bytes and displacement of error. If the correctable data error did not occur in the last block for this CCW, operation incomplete is also set.

If an uncorrectable data error is detected in any data block except the first, the storage director terminates the command with retry status. Channel end, device end, and unit check status are then presented on the retried CCW. If the uncorrectable error is in the first block, the storage director attempts recovery with command retry. If retry is unsuccessful, the command is terminated with channel end, device end, and unit check status.

An access error may occur as a result of an access movement initiated by the storage director when an access boundary is encountered during a multiple block transfer or when a defective block is encountered. If an access error is detected before data transfer is initiated, the storage director attempts recovery with command retry. If retry is unsuccessful, the command is terminated with channel end, device end, and unit check status. If the access error is detected after data transfer has been initiated, the command is terminated with channel end, device end, and unit check status.

### **Displace ID Subcommand**

No data transfer takes place on this subcommand. Channel end and device end are presented in ending status.

# Channel Programs

The following channel programs are typical examples of how CCWs are arranged to read and write records with a 3880/3370 subsystem. The examples do not include the system control program used to initiate the channel programs.

## Write

Example: Write three blocks of data in blocks 8840<sub>10</sub>, 8841<sub>10</sub>, and 8842<sub>10</sub> on the selected device. After writing the data, verify that it has been written correctly.

The channel program used is:

Define Extent  
Locate  
Write

### Define Extent

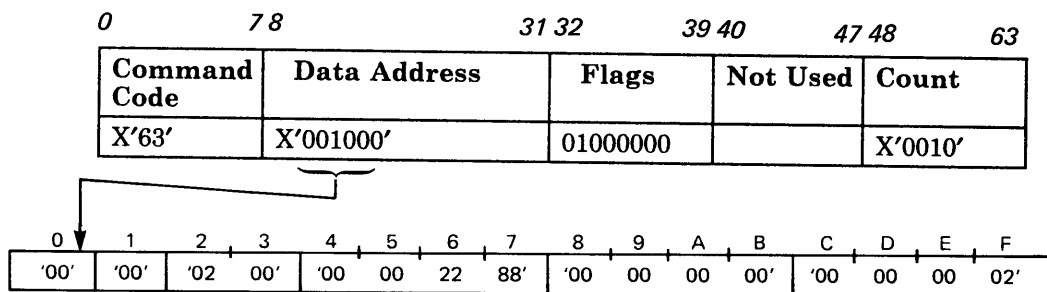

The parameters designated by the Define Extent command define the size and location of the data extent in which the following Locate and Write commands may operate. The parameters for this channel program are:

**Byte 0 = X'00'.** This mask byte allows non-format write operations.

**Byte 1 = X'00'.** This byte is not used and must be set to X'00'.

**Bytes 2 and 3 = X'0200'.** These bytes define the block size (512<sub>10</sub> bytes). If these bytes are zero, the block size defaults to 512<sub>10</sub>.

**Bytes 4 through 7 = X'00002288' (8840<sub>10</sub>).** These bytes specify the *physical* block number of the first block of the extent. In this case, the data specified in the following Write command is written in physical blocks 8840<sub>10</sub>, 8841<sub>10</sub>, and 8842<sub>10</sub>.

**Bytes 8 through 11 = X'00000000'.** These bytes specify the *logical* block number of the first block in the extent. In this case, the data is written in the first three blocks of the extent so the logical block number of the first block is zero.

**Bytes 12 through 15 = X'00000002'.** These bytes specify the logical block number of the last block in the extent. Three blocks (0, 1, and 2) are to be written, so block 2 is the last block of the extent.

Since the Locate command is to be chained to this command, the chain command flag (bit 33) is on in this CCW.

### Locate

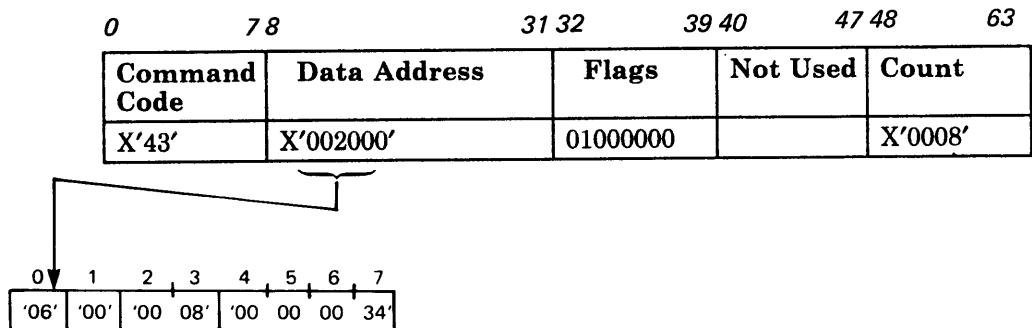

The parameters specified by the Locate command define the number of blocks to be written and the relative displacement of the first data block in the data set. The parameters for this channel program are:

**Byte 0 = X'05'.** This byte specifies that the operation to be performed is write data with verify.

**Byte 1 = X'00'.** This byte is not used for write operations and is set to X'00'.

**Bytes 2 and 3 = X'0003'.** These bytes specify the number of blocks to be written, in this case  $3_{10}$ .

**Bytes 4 through 7 = X'00000000'.** These bytes specify the relative displacement of the first block to be written from the beginning of the data set. In this case, these bytes are set to zero because the data is to be written in the first three blocks.

## Write

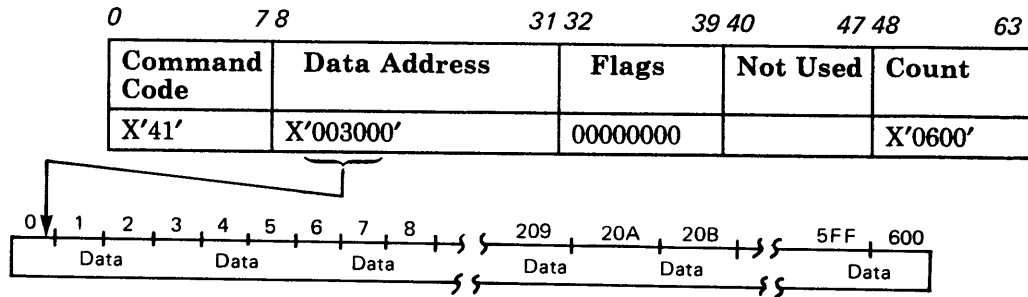

Execution of this command causes the data in main storage locations X'003000' through X'003600' to be written in the first three blocks of the data extent located at physical block number 8840<sub>10</sub>. Since the preceding Locate command specified write data and verify, the data just written is read back (without transferring it to main storage), and the error correction code (ECC) bytes written at the end of the last block are compared with the ECC bytes generated on the read-back operation.

Since the Write command is the last command in the channel program, the chain command flag is off.

## Read

Example: Read blocks 52<sub>10</sub> through 59<sub>10</sub> of a data set that is recorded in two extents. As shown below, the first extent begins at physical block number 50<sub>10</sub> and is 50<sub>10</sub> blocks long; the second extent begins at physical block number 147<sub>10</sub> and is 100<sub>10</sub> blocks long. Each block is 512<sub>10</sub> bytes.

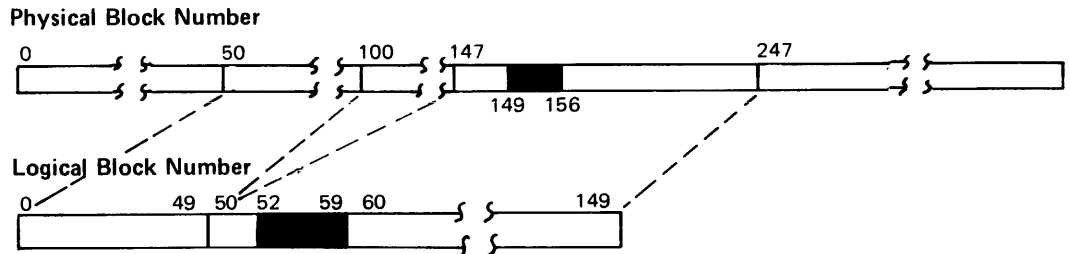

The channel program used is:

Define Extent  
Locate  
Read

### Define Extent

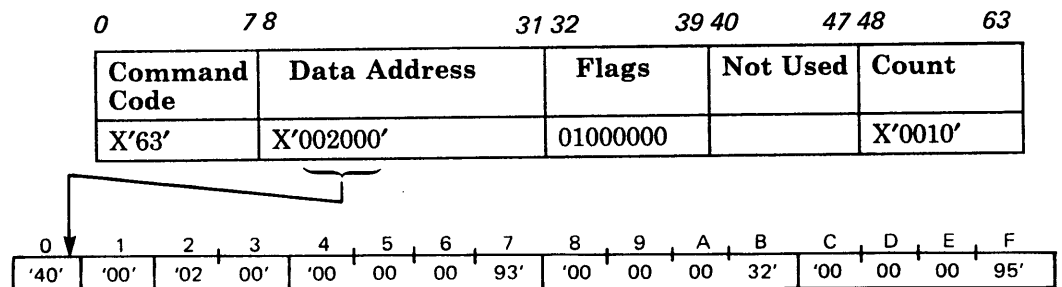

The parameters designated by the Define Extent command define the size and location of data extent in which the following Locate and Read commands may operate. The parameters for this channel program are:

**Byte 0 = X'40'.** This mask byte inhibits all Write and diagnostic commands and allows Read commands.

**Byte 1 = X'00'.** This byte is not used and should be set to zero.

**Bytes 2 and 3 = X'0200'.** These bytes define the block size. If these bytes are zero, the block size defaults to 512<sub>10</sub>.

**Bytes 4 through 7 = X'00000093'**. These bytes define the *physical* block number of the first block of the extent. In this case, 147<sub>10</sub>.

**Bytes 8 through 11 = X'00000032'**. These bytes specify the *logical* block number of the first block of the extent. In this case, 50<sub>10</sub>.

**Bytes 11 through 15 = X'00000095'**. These bytes specify the *logical* block number of the last block in the extent. In this case, 149<sub>10</sub>.

Since the Locate command is to be chained from this command, the chain command flag CCW.

### Locate

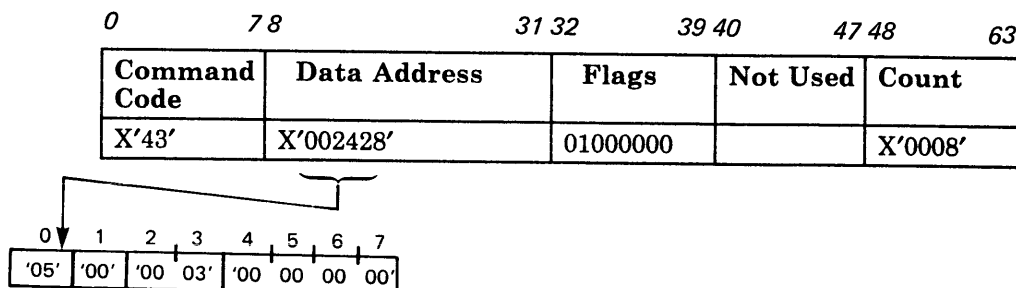

The parameters specified by the Locate command define the number of blocks to be read and the relative displacement of the first block in the data set. The parameters for this channel program are:

**Byte 0 = X'06'**. This byte specifies that the operation to be performed is read data.

**Byte 1 = X'00'**. This byte is not used for this operation and should be set to X'00'.

**Bytes 2 and 3 = X'0008'**. These bytes specify the number of blocks to be read. In this case, 8<sub>10</sub>.

**Bytes 4 through 7 = X'00000034'**. These bytes specify the *logical* block number of the first block of data to be read. In this case, 52<sub>10</sub>.

Since the Read command is to be chained from this command, the chain command flag (bit 33) is on in this CCW.



## Read

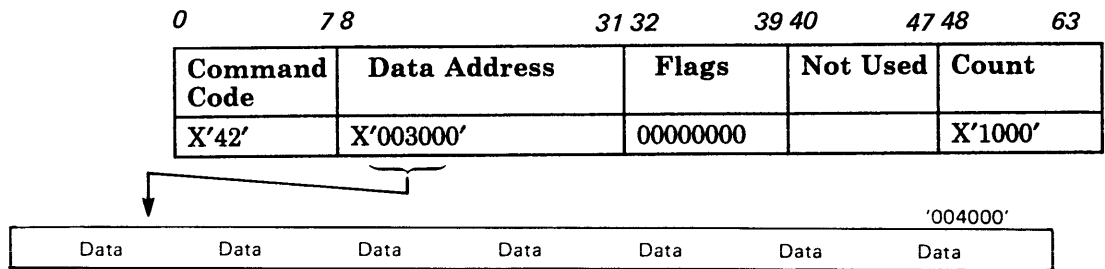

Execution of this command causes the data in physical blocks 149<sub>10</sub> through 156<sub>10</sub> to be read into main storage locations X'003000' through X'004000'.

Since the Read command is the last command in the channel program, the chain command flag is off.

## Chapter 4. Count, Key, and Data Command Set

Figure 4-1 on page 4-2 is a summary of the count, key, and data (CKD) command set. This section of the manual contains a detailed description of each command and its use for 3330, 3333, 3340, 3344, 3350, 3375, and 3380 operations. For illustration purposes, the CCW format for System/370 Mode, ECPS:VSE Mode, and 370-XA (Format 0) Mode is shown in the command examples.

Two commands, Define Extent and Locate Record, are used to notify the channel of the types of data transfer commands that will be executed and the limits in which they may operate. These commands replace the Seek, Set Sector, Set File Mask, and Search commands used in other channel programs.

The data transfer commands, Write Update Data, Write Update Key and Data, and Write CKD Next Track, are provided for write operations on consecutive records following execution of the Define Extent and Locate commands.

Three additional commands, Set Path Group ID, Sense Path Group ID, and Suspend Multipath Reconnection, are used to support attachment of the 3380 Models AA4, A04, and B04 with dynamic path selection to the 3880 Models 2 and 3. These commands are also used to support attachment of the 3380 Models AE4, AD4, BE4, BD4, AJ4 and AK4 to the 3880 Model 3.

COMMAND	COMMAND CODE			
	MULTITRACK OFF		MULTITRACK ON	
	HEXA-DECIMAL	BINARY	HEXA-DECIMAL	BINARY
<b>Control</b>				
No Operation (No Op)	'03'	0000 0011		
Recalibrate	'13'	0001 0011		
Seek	'07'	0000 0111		
Seek Cylinder	'08'	0000 1011		
Seek Head	'1B'	0001 1011		
Space Count	'0F'	0000 1111		
Set File Mask	'1F'	0001 1111		
Set Sector	'23'	0010 0011		
Restore	'17'	0001 0111		
Suspend Multipath Reconnection	'5B'	0101 1011		
Set Path Group Identifier (ID)	'5B'	0101 1011		
Define Extent	'63'	0110 0011		
Locate Record	'47'	0100 0111		
<b>Search</b>				
Home Address Equal	'39'	0011 1001	'B9'	1011 1001
Identifier (ID) Equal	'31'	0011 0001	'B1'	1011 0001
Identifier (ID) High	'51'	0101 0001	'D1'	1101 0001
Identifier (ID) Equal or High	'71'	0111 0001	'F1'	1111 0001
Key Equal	'29'	0010 1001	'A9'	1010 1001
Key High	'49'	0100 1001	'C9'	1100 1001
Key Equal or High	'69'	0110 1001	'E9'	1110 1001
<b>Read</b>				
Home Address	'1A'	0001 1010	'9A'	1001 1010
Read Special Home Address	'0A'	0000 1010		
Count	'12'	0001 0010	'92'	1001 0010
Record Zero (R0)	'16'	0001 0110	'96'	1001 0110
Data	'06'	0000 0110	'86'	1000 0110
Key and Data	'0E'	0000 1110	'8E'	1000 1110
Count, Key and Data (CKD)	'1E'	0001 1110	'9E'	1001 1110
Multiple Count, Key and Data	'5E'	0101 1110		
Initial Program Load (IPL)	'02'	0000 0010		
Sector	'22'	0010 0010		
<b>Sense</b>				
Sense Identification (ID)	'E4'	1110 0100		
Sense Path Group Identifier (ID)	'34'	0011 0100		
Sense	'04'	0000 0100		
Read and Reset Buffered Log	'A4'	1010 0100		
Device Reserve	'B4'	1011 0100		
Unconditional Reserve	'14'	0001 0100		
Device Release	'94'	1001 0100		
Read Device Characteristics	'64'	0110 0100		
<b>Write</b>				
Home Address	'19'	0001 1001		
Write Special Home Address	'09'	0000 1001		
Record Zero (R0)	'15'	0001 0101		
Erase	'11'	0001 0001		
Count, Key and Data (CKD)	'1D'	0001 1101		
Special Count, Key and Data	'01'	0000 0001		
Data	'05'	0000 0101		
Key and Data	'0D'	0000 1101		
Update Data	'85'	1000 0101		
Update Key and Data	'8D'	1000 1101		
CKD Next Track	'9D'	1001 1101		
<b>Diagnostic</b>				
Diagnostic Sense	'44'	0100 0100		
Diagnostic Load	'53'	0101 0011		
Diagnostic Write	'73'	0111 0011		
Diagnostic Control	'F3'	1111 0011		
Diagnostic Sense/Read	'C4'	1100 0100		

*READ A CYCLE HS only*

Figure 4-1. Summary of Count, Key, and Data Command Set

# No-Operation

0	7 8	31 32	39 40	47 48	63
Command Code	Data Address	Flags	Not Used	Count (Decimal)	
0000 0011 X'03'	Ignored	Used at the discretion of the programmer		Must be nonzero to avoid program check	

## Function

The No-Operation (No-Op) command is used to maintain channel connection during I/O operations.

## Chaining Requirements

None.

## Status

Channel end and device end are presented in initial status.

## Description

The No-Op command is processed as an immediate command. (Channel end is signaled immediately upon receipt of the command code.) It causes no action at the addressed device.

The No-Op command resets orientation information in the storage director. Indiscriminate usage of the No-Op command within CCW chains may cause records or parts of records to be skipped. For example, a No-Op inserted between a Read Count command and a Read Data command may cause the data area of the following record to be read. Also, a No-Op inserted between a command that reads the data area of record N-1 and a command that must process the count area of record N, may skip one or more records and process the count area of a subsequent record.

# Read Count

0	7 8	31 32	39 40	47 48	63
Command Code	Data Address	Flags	Not Used	Count (Decimal)	
0001 0010 X'12' <b>Multitrack:</b> 1001 0010 X'92'	Specifies the main storage location where the first byte of count data is to be transferred	Used at the discretion of the programmer		8	

## Function

The Read Count command transfers the count area of a record from the drive to the channel.

## Chaining Requirements

If the 3380 AJ4/AK4 Attachment (Feature 3005) is installed, this command must be preceded by a Seek, Seek Cylinder, Read IPL, Locate Record, or Recalibrate command.

## Status

Initial status is normally zero. Channel end and device end are presented after reading the count area correction code bytes.

## Description

The Read Count command transfers eight bytes: record ID (five bytes), key length (one byte), and data length (two bytes).

The validity of the data is verified by the correction code bytes following the count area. If a data overrun or data check is detected on a 3330, 3350, 3375, or 3380 during the execution of this command, the storage director attempts recovery with command retry. If command retry is unsuccessful, channel end, device end, and unit check status are presented to the channel.

# Recalibrate

0	7 8	31 32	39 40	47 48	63
Command Code	Data Address	Flags	Not Used	Count (Decimal)	
0001 0011 X'13'	Ignored	Used at the discretion of the programmer		Must be nonzero to avoid program check	

## Function

The Recalibrate command causes the addressed drive to seek to cylinder zero, head zero.

## Chaining Requirements

None.

## Status

Initial status is normally zero. Channel end is presented as ending status and device end is presented after the access is positioned at cylinder zero, head zero.

## Description

The Recalibrate command is processed similarly to a seek command and the file mask must be set to allow seeks. A Recalibrate command following a Define Extent command will be executed only if cylinder zero is included in the defined extent.

# Read Record Zero

0	7 8	31 32	39 40	47 48	63
Command Code	Data Address	Flags	Not Used	Count (Decimal)	
0001 0110 X'16' <b>Multitrack:</b> 1001 0110 X'96'	Specifies the main storage location where the first byte of record zero count data is to be transferred	Used at the discretion of the programmer		Specifies the number of count, key, and data bytes to be read	

## Function

The Read Record Zero (R0) command transfers the count, key, and data bytes of record zero from the drive to the channel.

## Chaining Requirements

If the 3380 AJ4/AK4 Attachment (Feature 3005) is installed, this command must be preceded by a Seek, Seek Cylinder, Read IPL, Locate Record, or Recalibrate command.

## Status

Initial status is normally zero. Channel end and device end are presented after reading the data area correction code bytes.

## Description

Record 0, the track descriptor record, has the normal count, key, and data format and may be used as a normal data record. However, it is usually reserved by the operating system for nonuser functions.

During the execution of this command, the storage director searches for index, clocks through gap G1, home address, and gap G2, and transfers the count, key, and data areas of R0 to the channel.

*Note: A Read R0 chained from a Read Home Address or Search Home Address command is executed immediately and does not cause a search for index.*

The validity of each of the count, key, and data areas is verified by the correction code bytes following each of the areas.

If a data overrun or data check is detected on a 3330, 3350, 3375, or 3380 during the execution of this command, the storage director attempts recovery with command retry. If command retry is unsuccessful, channel end, device end, and unit check status are presented to the channel.

# Read Data

0	7 8	31 32	39 40	47 48	63
Command Code	Data Address	Flags	Not Used	Count (Decimal)	
0000 0110 X'06' Multitrack: 1000 0110 X'86'	Specifies the main storage location to where the first byte of data is to be transferred	Used at the discretion of the programmer			Specifies the number of bytes to be read

## Function

The Read Data command transfers the data area of a record from the drive to the channel.

## Chaining Requirements

If the 3380 AJ4/AK4 Attachment (Feature 3005) is installed, this command must be preceded by a Seek, Seek Cylinder, Read IPL, Locate Record, or Recalibrate command.

## Status

Initial status is normally zero. Channel end and device end are presented after reading the data area correction code bytes.

## Description

When the Read Data command is chained from a Search ID, Read Count, Search Key, or Space Count command, it transfers the data area of the record operated on by the immediately preceding CCW. When the Read Data command is chained from a Locate Record command (byte 0 bit 0 = 0), it transfers the data area of the record that satisfied the search operation. Otherwise, it transfers the data area of the record following the next count area (excluding R0) read on the track.

The validity of the data is verified by the correction code bytes following the data area. If a data overrun or data check is detected on a 3330, 3350, 3375, or 3380 during the execution of this command, the storage director attempts recovery with command retry. If command retry is unsuccessful, channel end, device end, and unit check status are presented to the channel.

If the data error is correctable, the correctable sense bit is set along with the pattern and displacement bytes of the error so that the system error recovery procedures can correct the error.



# Read Key and Data

0	7 8	31 32	39 40	47 48	63
Command Code	Data Address	Flags	Not Used	Count (Decimal)	
0000 1110 X'0E' <b>Multitrack:</b> 1000 1110 X'8E'	Specifies the main storage location to where the first byte of data is to be transferred	Used at the discretion of the programmer			Specifies the number of bytes to be read

## Function

The Read Key and Data command transfers the key and data areas of a record from the drive to the channel.

## Chaining Requirements

If the 3380 AJ4/AK4 Attachment (Feature 3005) is installed, this command must be preceded by a Seek, Seek Cylinder, Read IPL, Locate Record, or Recalibrate command.

## Status

Initial status is normally zero. Channel end and device end are presented after reading the data area correction code bytes.

## Description

When the Read KD command is chained from a Search ID, Read Count, Search Key, or Space Count command, it transfers the key and data areas of the record operated on by the immediately preceding CCW. When the Read KD command is chained from a Locate Record command (byte 0 bit 0 = 0), it transfers the key and data areas of the record that satisfied the search operation. Otherwise, it transfers the key and data areas of the record following the next count area (excluding R0) read on the track.

The validity of the data is verified by the correction code bytes following the key and data areas. If a data overrun or data check is detected on a 3330, 3350, 3375, or 3380 during the execution of this command, the storage director attempts recovery with command retry. If command retry is unsuccessful, channel end, device end, and unit check are presented to the channel at the end of the area in which the error occurred.

If a correctable data error is detected in the data area, the correctable sense bit is set along with the pattern and error displacement bytes so that the system error recovery procedures can correct the error.

# Read Count, Key, and Data

0	7 8	31 32	39 40	47 48	63
Command Code	Data Address	Flags	Not Used	Count (Decimal)	
0001 1110 X'1E' <b>Multitrack:</b> 1001 1110 X'9E'	Specifies the main storage location where the first byte of count data is to be transferred	Used at the discretion of the programmer		Specifies the number of count, key, and data bytes to be read	

## Function

The Read Count, Key, and Data command transfers the count, key, and data areas of a record from the drive to the channel.

## Chaining Requirements

If the 3380 AJ4/AK4 Attachment (Feature 3005) is installed, this command must be preceded by a Seek, Seek Cylinder, Read IPL, Locate Record, or Recalibrate command.

## Status

Initial status is normally zero. Channel end and device end are presented after reading the data area correction code bytes.

## Description

The count, key, and data area of the record read by this command are from the next record (excluding R0) on the track.

The validity of the data is verified by the correction code bytes following each area. If a data overrun or data check is detected on a 3330, 3350, 3375, or 3380 during the execution of this command, the storage director attempts recovery with command retry. If command retry is unsuccessful, channel end, device end, and unit check are presented to the channel at the end of the area in which the error occurred.

If a correctable data error is detected in the data area, the correctable sense bit is set along with the pattern and displacement bytes of the error so that the system error recovery procedures can correct the error.

# Read Multiple Count, Key, and Data

0                      7 8                                      31 32                                      39 40                                      47 48                                      63

Command Code	Data Address	Flags	Not Used	Count (Decimal)
0101 1110 X'5E'	Specifies the main storage location where the first byte of data is to be transferred	Used at the discretion of the programmer		Larger than maximum R1 capacity. 3330/3333 - 13,030 3340/3344 - 8,368 3350 native - 19,069 3377 - 35,616 3380 - 47,476

## Function

The Read Multiple Count, Key, and Data (CKD) command transfers the next record (excluding R0) and all remaining records on the track from the storage director to the channel.

## Chaining Requirements

The Read Multiple CKD command should be preceded by a Set File Mask command inhibiting head switching to avoid processing overflow records that may continue on the next track.

If the 3380 AJ4/AK4 Attachment (Feature 3005) is installed, this command must be preceded by a Seek, Seek Cylinder, Read IPL, Locate Record, or Recalibrate command.

## Status

Initial status is normally zero. Channel end and device end are presented after the last record on the track has been read.

## Description

This command provides a means for reading all the records on a track in a single disk revolution. It is similar to executing a chain of Read CKD commands which reads records into contiguous main storage locations.

Reading starts at the next count field encountered (excluding R0) and continues until the last record on the track has been read. If a Read Multiple CKD command is issued after the count field of the last record on the track has been passed (but prior to index), channel end and device end status are presented and no data is transferred.

Since the actual number of bytes to be read is probably not known, the byte count should be greater than track capacity of the device. If the Read Multiple CKD is the last CCW in the chain, the residual count, with the CCW count, can be used to determine how many bytes were really read.

If less than maximum track capacity is specified in the count field, execution stops at the end of the record being transferred when the byte count goes to zero.

*Uncorrectable Data Checks:* These checks are usually not retried by the storage director. Data check is set in the sense bytes and data transfer stops at the end of the area in which the error occurred. For 3380s, command retry is used only on the first record processed by the command.

*Correctable Data Checks:* These checks are usually not retried by the storage director. Displacement information is provided in the sense information to aid in building a restart CCW chain for error recovery. For 3375s and 3380s, command retry is used only on the first record processed by the command.

*Command Overruns:* The storage director uses command retry when a command overrun is detected. For 3375s and 3380s, command retry is used only on the first record processed by the command.

*Data Overruns:* These errors are not usually retried by the storage director. Data overrun is set in the sense information and system error recovery procedures are used to recover from the error. For 3375s and 3380s, command retry is used only on the first record processed by the command.

The Read Multiple CKD command does not have to start at the beginning of a track. For example, if a track has 50 records and the key field of record 26 cannot be read, the following chain will read the first 25 records and detect the error in the key area of record 26:

Read Home Address  
Read R0  
Read Multiple CKD

Analysis of the sense information, residual count, CCW count, and the records already transferred to main storage, allows construction of the following chain:

Search ID (record 26)  
TIC \*-8  
Read Data  
Read Multiple CKD

This chain would recover the data area of record 26 and all subsequent records on the track. The only unrecovered data would be the key area of record 26.

*Note:* Because command retry only works on single records, certain errors cannot be retried in the multi-record mode after the first record has been processed. Use of this command should be limited to those applications where its convenience outweighs the exposure to reduced error recovery capability.

Count  
Read  
Data

# Read Initial Program Load

0	7 8	31 32	39 40	47 48	63
Command Code	Data Address	Flags	Not Used	Count (Decimal)	
0000 0010 X'02'	Specifies the main storage location where the first byte of data is to be transferred	Used at the discretion of the programmer			Specifies the number of bytes to be read

## Function

The Read Initial Program Load (IPL) command causes the addressed device to seek to cylinder zero, head zero, and read the data area of record 1.

## Chaining Requirements

The Read IPL command cannot be preceded by a Space Count, Set File Mask, or Define Extent command in the same chain.

## Status

Initial status is normally zero. Channel end and device end are presented after reading the data area correction code bytes.

## Description

The Read IPL command is normally initiated by selecting a unit address and initiating the IPL from the system console. The Read IPL command causes the addressed device to seek to cylinder zero, head zero, and search for index. When index is detected, the storage director clocks over record zero and reads the data area of record 1.

The validity of the data is verified by the correction code bytes following the data area. If a data overrun or data check is detected on a 3330, 3350, 3375, or 3880 during execution of this command, the storage director attempts recovery with command retry. If retry is unsuccessful, channel end, device end, and unit check status are presented to the channel at the end of the area in which the error occurred.

If a correctable data error is detected in the data area, the correctable sense bit is set along with the pattern and displacement bytes of the error so that system error recovery procedures can correct the error.

If the speed matching buffer for 3375 or 3380 feature is installed in the 3880, the Read IPL command is executed as though it was preceded by a Define Extent command with a mask byte of X'00', a global attributes byte of X'C0', a block size of X'00', and an extent that includes the entire volume.

# Read Sector

0	7 8	31 32	39 40	47 48	63
Command Code	Data Address	Flags	Not Used	Count (Decimal)	
0010 0010 X'22'	Specifies the main storage location where the sector number is to be stored	Used at the discretion of the programmer		1	

## Function

The Read Sector command transfers one byte of data (sector number) from the storage director to the channel.

## Chaining Requirements

None.

## Status

Initial status is normally zero. Channel end and device end are presented after the sector number has been transferred.

## Description

The byte transferred to the channel contains the angular position number required to access the last record processed on the drive. If no record has been processed since the last Set Sector command, the value is that set in the Set Sector command, minus four for the 3330 or 3350, minus three for the 3340 or 3344, and unpredictable for 3375 and 3380.

If the last record processed was an overflow record, the angular position returned is that of the last segment.

A system reset or power-on sequence causes the sector value to be reset. Also, the execution of this command resets orientation information in the storage director.

If the last record processed on a 3375 was home address or record zero, the sector value at home address will be returned. This value should not be used by a subsequent Set Sector command to reconnect on home address or record zero. A sector value of zero should be used.

If this command is issued to a device that does not have RPS, the byte returned to the channel will be X'00'.

# Sense Identification

Command Code	Data Address	Flags	Not Used	Count (Decimal)
1110 0100 X'E4'	Specifies the main storage location where the first byte of sense data is to be transferred	Used at the discretion of the programmer		7

## Function

The Sense Identification command transfers seven bytes of sense information from the storage director to the channel.

## Chaining Requirements

None.

## Status

Initial status is normally zero. Channel end and device end are presented after the sense bytes are transferred.

## Description

The sense information transferred by this command describes the type and model of the storage director and device being addressed by this command.

Sense and track orientation information is reset after the execution of this command.

The format of the sense bytes is shown in Figure 4-3 on page 4-59.

DEVICE TYPE	ALWAYS FF	STORAGE CONTROL (SEE NOTE 1)			DEVICE		
		Byte 0	1	2	3	4	5
3330-1/2	FF	38	80	01	33	30	01
3330-11	FF	38	80	01	33	30	11
3340 (35 MB data module)	FF	38	80	01	33	40	01
3340 (70 MB data module)	FF	38	80	01	33	40	02
3344	FF	38	80	01	33	44	00
3350	FF	38	80	01	33	50	00
3375	FF	38	80	01 (Note 2)	33	75	00
3380	FF	38	80	03 (Note 3)	33	80	(Notes 4 and 5)

NOTES:

- Models 1, 2, and 4 = '01'; Model 2 with 3380 = '03'; Model 3 = '03'; Model 11 = '08'; Model 13 = '49'; Model 21 = '0A'; Model 23 = 'CB'.
- If the speed matching buffer for 3375 feature is installed in the 3880, byte 3 is 'C1', if the Channel Speed Control switch is set for high speed (data streaming); or 'E1' if it is set for low speed (offset interlock).
- If the speed matching buffer for 3380 feature is installed in the 3880, byte 3 is:  
C3 if the Channel Speed Control switch is set for high speed (data streaming)  
E3 if the Channel Speed Control switch is set for low speed (offset interlock)  
If the 3380 AJ4/AK4 Attachment feature 3005 is installed, byte 3 is 05.
- If dynamic path selection function is installed, byte 6 = '02'. If dynamic path selection function is not installed, byte 6 = '00'.
- The following shows the values in byte 6 for the different 3380 Models:  
AA4/B04=02, AD4/BD4=06, AJ4/BJ4=12, AE4/BE4=0A, and AK4/BK4=1A

**Figure 4-3. Format of Sense Identification Bytes**



# Seek

Command Code	Data Address	Flags	Not Used	Count (Decimal)
0000 0111 X'07'	Specifies the main storage location of the seek address	Used at the discretion of the programmer		6

## Function

The Seek command transfers the seek address from the channel to the storage director.

## Chaining Requirements

If the 3380 AJ4/AK4 Attachment (Feature 3005) is installed, this command must be preceded by a Seek, Seek Cylinder, Read IPL, Locate Record, or Recalibrate command.

## Status

Initial status is normally zero. Channel end and device end are presented after the seek address has been transferred. See the description below for other status conditions.

## Description

The Seek command transfers the six-byte seek address from the channel to the storage director. The storage director saves the address to allow positioning of the access mechanism at a later time. If the seek address indicates that no access motion is required, the proper head is selected before channel end status and device end status are presented.

The storage director checks the seek address for validity (see the following chart). If the seek address is not valid, channel end, device end, and unit check with command reject are presented in ending status.

The format for the seek address is:

Byte	0	1	2	3	4	5
	0	0	C	C	H	H

# Sense Path Group Identifier

0	7 8	31 32	39 40	47 48	63
Command Code	Data Address	Flags	Not Used	Count (Decimal)	
0110 0100 X'34'	Specifies the main storage location where the first byte of path ID information is to be transferred	Used at the discretion of the programmer		12	

## Function

The Sense Path Group Identifier command transfers 12 bytes of path identification information from the storage director to main storage. This command is valid only for devices with the dynamic path selection function.

## Chaining Requirements

The Sense Path Group ID command must be the only command in the chain.

## Status

This command is privileged in that it will be executed without testing the status of the addressed device; therefore, initial status is normally zero. Channel end and device end are presented after the path ID information has been transferred.

## Description

The 12 bytes of information transferred to main storage are the path state byte (byte 0) and the path group identification (bytes 1 through 11). The path group ID used is the one transferred by the Set Path Group ID command issued since the last system reset or IML of the storage director.

## Byte 0

The path state byte has the following format:

<b>Bits</b>	<b>Description</b>
0, 1 = 00	No Set Path Group ID command was executed on the channel for any device since the last system reset.
0, 1 = 10	A valid ID exists for this channel and the addressed device does not belong to a group.
0, 1 = 11	A valid ID exists for this device on this channel and the device is shared by a group.
2, 3 = 00	The addressed device is not currently reserved.
2, 3 = 10	The addressed device is reserved to another channel.
2, 3 = 11	The addressed device is reserved to this channel and to other members of the path group (if they exist).
4 = 0	Single path mode.
4 = 1	Multiple path mode.
5-7	Set to zero.

## Bytes 1 through 11

Bytes 1 through 11 contain the current path group ID associated with the channel path over which the command is executed. If no Set Path Group ID command has been issued by this channel since the last system reset, bytes 1 through 11 will contain zeros. If a valid ID exists for this channel, even if it had not been addressed to this particular device, it will be returned in this field.

# Sense

Command Code	Data Address	Flags	Not Used	Count (Decimal)
0000 0100 X'04'	Specifies the main storage location where the first byte of sense information is to be transferred	Used at the discretion of the programmer		24

## Function

The Sense command transfers 24 bytes of sense information from the storage director to the channel.

## Chaining Requirements

None.

## Status

Initial status is normally zero. Channel end and device end are presented after the sense bytes are transferred.

## Description

The sense information transferred by this command describes the reasons for unit check status, the current status of the device that performed the operation, and system error recovery information.

A unit check should always be followed by a Sense command whether the information is used or not. Otherwise, expected future interrupts may not occur and some I/O access paths may not be available.

A contingent connection state is established in the storage director after the channel accepts a status byte containing unit check. This state lasts until a command (other than Test I/O or No-Op) receives an initial status byte of zero for the storage director and device address which generated the unit check. During the contingent connection state, the storage director is busy to all addresses other than the address for which the contingent connection was established.

Sense information is reset to zero after data transfer is complete or when an initial status byte of zero is given to any command except Test I/O or No-Op.

Execution of a Sense command resets track orientation information in the storage director.

Sense information for the 3880 and its attached devices is described later in this manual.

A Sense command issued during a contingent connection should be a stand alone command. This is because much of the device status testing normally performed as part of initial selection is bypassed so that zero initial status can be presented and error information related to the last unit check can be reported. If other commands are chained from the Sense command, the device may not be prepared to execute them, which could result in unpredictable results.

# Read and Reset Buffered Log

Command Code	Data Address	Flags	Not Used	Count (Decimal)
1010 0100 X'A4'	Specifies the main storage location where the first byte of usage/error information is to be transferred	Used at the discretion of the programmer		24

## Function

The Read and Reset Buffered Log command transfers 24 bytes of usage/error information from the storage director to the channel.

## Chaining Requirements

None.

## Status

Initial status is normally zero. Channel end and device end are presented after the usage/error information is transferred.

## Description

The format of the usage/error information transferred to the channel is the same as the 24 bytes of sense information generated after the usage or error counters overflow. (See the Statistical Usage/Error Recording section of this manual.)

The usage/error statistics pertain to the logical device addressed by the Start I/O instruction. The statistics are reset to zero after data transfer is complete.

Execution of a Read and Reset Buffered Log command resets track orientation information in the storage director.

For the 3380, the counts are only updated at the end of a chain. If a Read and Reset Buffered Log command is executed in a CCW chain, it will not report any counts accumulated during that chain.

# Device Reserve

0	7 8	31 32	39 40	47 48	63
Command Code	Data Address	Flags	Not Used	Count (Decimal)	
1011 0100 X'B4'	Specifies the main storage location where the first byte of sense data is to be transferred	Used at the discretion of the programmer		24	

## Function

The Device Reserve command reserves the addressed device to the channel issuing the command, or if used with the dynamic path selection function, to all channels in the same path group.

## Chaining Requirements

The Device Reserve command cannot be preceded by a Set File Mask or Space Count command in the same chain.

## Status

Initial status is normally zero. Channel end and device end are presented after the 24 sense bytes that have been transferred.

## Description

Besides reserving the addressed device, the Device Reserve command transfers the 24 sense bytes to the channel.

Reservation is maintained until the channel, or any channel in the same path group, successfully completes a Device Release command to the device.

A system reset will remove reservation of the device to the resetting channel only.

Execution of a Device Reserve command resets track orientation information in the storage director.

A Device Reserve command for the 3375 will be executed regardless of any abnormal device status conditions (such as offline or unsafe) except for 3375 string switch or dual controller configurations. For these cases, the 3880 will present a unit check condition indicating intervention required.

See the description of the Set Path Group Identification command for additional information regarding device reservation with the dynamic path selection function.

# Unconditional Reserve

Command Code	Data Address	Flags	Not Used	Count (Decimal)
0001 0100 X'14'	Specifies the main storage location where the first byte of sense data is to be transferred	Used at the discretion of the programmer		24

## Function

The Unconditional Reserve command is used for 3350s, 3375s, and 3380s only. The Unconditional Reserve command breaks device allocation to any other path and establishes allocation to the path executing the command.

## Chaining Requirements

The Unconditional Reserve command must be the first command in a chain or the command is rejected with channel end, device end, and unit check status.

## Status

Initial status is normally zero. Channel end and device end are presented after the 24 sense bytes have been transferred.

## Description

The Unconditional Reserve command is used to recover from hardware malfunctions. It carries out all of the functions of the Device Reserve command and, in addition, reserves the device to the executing path even when the device was reserved or in use through another path. Reservation or information in use for the other path is reset in the device and storage director through which the command was issued. It does not reset information in the other storage director.

Control of the device must be established by the system before the Unconditional Reserve command can be issued. Device control is established if the system has the device reserved, or the system has a CCW chain in progress (between the Start I/O instruction with a condition code of 0, and the ending interrupt). If the system issues an Unconditional Reserve command to a device not assigned to it, one of the following conditions may occur on the other system.



- If the device was reserved, the reservation is reset and the device becomes reserved to the channel that issued the Unconditional reserve command.
- If the device is disconnected between chained commands, an interrupt will be lost.
- If the device is active when the command is executed, a recoverable equipment check will be presented.
- If the device is idle and not reserved, there is no effect.

If the system does not want the device reserved to the issuing path, it must issue a Device Release command. (The Device Release command may be chained to the Unconditional Reserve command.)

Execution of an Unconditional Reserve command resets track orientation information in the storage director.

The Unconditional Reserve command will be executed regardless of any abnormal device status (such as offline or unsafe) unless the device does not respond to the selection tag or there is a preselection (indicated by unit check status and equipment check in sense byte 0).

*Note: For configurations that include string switches or dynamic path selection, execution of an Unconditional Reserve on storage director A and device N can abort an unrelated operation on storage director B and device M.*

# Device Release

Command Code	Data Address	Flags	Not Used	Count (Decimal)
1001 0100 X'94'	Specifies the main storage location where the first byte of sense data is to be transferred	Used at the discretion of the programmer		24

## Function

The Device Release command terminates the reservation of the addressed device from the channel, or if used with the dynamic path selection function, from all channels in the same path group.

## Chaining Requirements

The Device Release command cannot be preceded by a Set File Mask or Space Count command in the same chain.

## Status

Initial status is normally zero. Channel end and device end are presented after the 24 sense bytes have been transferred.

## Description

Besides terminating the reservation of the addressed device, the Device Release command transfers 24 sense bytes to the channel.

A Device Release command will be executed regardless of any abnormal device status conditions (such as offline or unsafe).

A Device Release command for the 3375 will be executed regardless of any abnormal device status conditions (such as offline or unsafe) except for 3375 string switch or dual controller configurations. For these cases, the 3880 will present a unit check condition indicating intervention required.

# Read Device Characteristics

0	7 8	31 32	39 40	47 48	63
Command Code	Data Address	Flags	Not Used	Count (Decimal)	
0110 0100 X'64'	Specifies the main storage location where the first byte of sense data is to be transferred	Used at the discretion of the programmer			64

## Function

The Read Device Characteristics command transfers 64 bytes of device characteristics from the storage director to the channel. This command is supported only by the 3380 Extended Attachment feature and the 3880 Model 3 with the 3380 AJ4/AK4 Attachment (Feature 3005) installed.

## Chaining Requirements

None.

## Status

Initial status is normally zero. Channel end and device end are presented after the data bytes have been transferred.

## Description

The information transferred by this command defines the characteristics of the addressed device. Execution of this command resets orientation in the control unit.

The format for the device characteristics information is shown in Figure 4-4 on page 4-70.

Valid Seek Address**	3330		3340 (35 MB)	3340 (70 MB)	3344 (70 MB)	3350	3375	3380		
	Models 1 or 2	Model 11						Models AA4/A04/B04 AD4/BD4 AJ4/BJ4	Models AE4/BE4	Models AK4/BK4
Bytes 0, 1 and 4 must be:	0	0	0	0	0	0	0	0	0	0
Bytes 2 and 3 are not greater than:	410	814	348*	697*	697*	559*	959*	885*	1770*	2655*
Byte 5 is not greater than:	18	18	11	11	11	29	11	14	14	14
CE cylinders are:			349	698 699	2,800 through 2,804	1,024	960	886	1771	2658
SA cylinders			350	700	2,805	1,025	961	-3***	1780 and 1781	2667 2668 2669
* Unless the file mask bit 5 is on. **All values are decimal. *** File mask bit 5 must be on.										

If access motion is required, it is not initiated until a Set Sector, read, search, write, Write Special Home Address, Read Special Home Address, or Space Count command is received in the same chain or until the CCW chain ends normally. If more than one Seek command is received in the CCW chain before access motion is initiated, only the last Seek command will cause access motion.

If the CCW chain ends normally and the last Seek command has not been initiated, the storage director initiates the seek after disconnecting from the channel. If the device is addressed by another command before the seek is completed, device end is not generated, but busy status is presented.

The Seek command does not have to be preceded by another CCW in order to be executed. However, if a Define Extent or Set File Mask command has been issued, the file mask must be set to allow seeks. (See the Set File Mask section of this manual.) If preceded by a Define Extent command, the seek address must also be within the defined extent. (See the Define Extent command section of this manual.)

Execution of a Seek command resets track orientation information in the storage director.

Byte	Contents	3380 A04 AA4/B04	3380 AD4/BD4	3380 AJ4/BJ4	3380 AE4/BE4	3380 AK4/BK4
00-01	Control Unit Type	3880	3880	3880	3880	3880
02	Control Unit Model					
	Without SMB	03	03	03	03	03
	With SMB	C3	N/A	N/A	N/A	N/A
	With Feature 3005	N/A	05	05	05	05
03-04	Device Type	3380	3380	3380	3380	3380
05	Device Model	02	06	16	0A	1E
06	Device features	00	00	80	00	80
07	Storage features	zeros	zeros	zeros	zeros	zeros
08	Features	zeros	zeros	zeros	zeros	zeros
09	Storage Director features	00	00	00	00	00
10	Device Class code	20	20	20	20	20
11	Device Type code	0E	0E	0E	0E	0E
12-13	Number of primary cylinders	0375	0375	0375	06EA	0A5F
14-15	Number of tracks per cylinder	000F	000F	000F	000F	000F
16	Number of sectors	DE	DE	DE	DE	DE
17-19	Total track length usable for data records	00BB60	00BB60	00BB60	00BB60	00BB60
20-21	Length of home address and record zero	0440	0440	0440	0440	0440
22	Track capacity calculation formula code	01	01	01	01	01
23	Track capacity calculation factor 1	20	20	20	20	20
24-25	Track capacity calculation factor 2	01EC	01EC	01EC	01EC	01EC
26-27	Track capacity calculation factor 3	00EC	00EC	00EC	00EC	00EC
28-29	Address of first alternate cylinder	0375	0375	0375	06EA	0A5F
30-31	Number of alternate tracks	000F	000F	000F	000F	000F
32-33	Address of first diagnostic cylinder	0376	0376	0376	06EB	0A62
34-35	Number of diagnostic tracks	000F	000F	000F	000F	000F
36-37	Address of first device support cylinder	FFFD	FFFD	FFFD	06F4	0A6B
38-39	Number of device support tracks	000F	000F	000F	001E	002D

Figure 4-4 (Part 1 of 2). Read Device Characteristics, Bytes 0 through 63

Byte	Contents	3380 A04 AA4/B04	3380 AD4/BD4	3380 AJ4/BJ4	3380 AE4/BE4	3380 AK4/BK4
40	MDR record identification	14	1C	21	1B	23
41	OBR record identification	0E	1E	21	2E	23
42	CU Type					
	With or without SMB	zeros	zeros	zeros	zeros	zeros
	With Feature 3005	N/A	09	09	09	09
43	Not used	zeros	zeros	zeros	zeros	zeros
44-45	Length of Record					
	With or without SMB	zeros	zeros	zeros	zeros	zeros
	With Feature 3005	N/A	BB74	BB74	BB74	BB74
46-63	Not used	zeros	zeros	zeros	zeros	zeros

**Figure 4-4 (Part 2 of 2). Read Device Characteristics, Bytes 0 through 63**

# Write Home Address

0            7 8                            31 32                            39 40                            47 48                            63

Command Code	Data Address	Flags	Not Used	Count (Decimal)
0001 1001 X'19'	Specifies the main storage location of the home address bytes	Used at the discretion of the programmer		5 for 3330, 3333, 3375, 3380 7 for 3340, 3344 11 for 3350

## Function

The Write Home Address command causes a home address area to be transferred from main storage and written on the drive.

## Chaining Requirements

The Write Home Address command must be chained from a successful Search Home Address command with a CCW count of four or more unless the command is used by a 3340, 3344, or 3350 to flag the track as defective. It must be preceded by a Set File Mask command that allows writing of the home address. A Write Home Address command on a 3330-I, 3330-II or 3333 device does not require a Search Home Address, only a valid File Mask.

The Write Home Address command may also be chained from a Locate Record command that specified a Format Write (with search modifier) subcommand.

## Status

Initial status is normally zero. Channel end and device end are presented after the correction code bytes have been written at the end of the home address area.

## Description

One home address area is written on each track to establish track identity, a requirement to perform data operations on that track. The home address is normally written on the tracks by the disk manufacturer. The use of this command should be limited to identifying defective tracks and assigning alternate tracks. Utility programs are available to perform these functions.

During the execution of this command, the storage director orients on index and then writes gap G1, home address, and the correction code bytes. Bits 0 through 5 of the flag byte are generated by the storage director before the flag byte is transferred to the drive.

The cylinder and head numbers from main storage must match the value stored by the storage director on the most recent seek, or the command is not executed.

If a Write Home Address command is the last format write command in a chain, the remaining portion of the track is erased. If a command other than a Write R0 is chained from the Write Home Address, it is executed after the track is erased. Since reconnection may not occur until some time after index, the next command will not be oriented.

### **3330, 3375, and 3380 Home Address Area**

The home address area consists of a flag (1 byte), cylinder number (2 bytes), and a head number (2 bytes). For 3380s, the CCW count must be 5; for 3330 and 3375, if the CCW count is less than five, the storage director writes zeros in the remaining bytes. If the CCW count is greater than five, only five bytes are written. For 3375s and 3380s, the cylinder and head number must be the address of the track.

*Note: Although the home address is longer than five bytes, only those five bytes are transferred.*

### **3350 Home Address Area**

The home address area consists of the skip displacement (6 bytes), flag (1 byte), cylinder number (2 bytes), and head number (2 bytes). If the CCW count is less than seven, the command is rejected. If the CCW count is less than 11, the storage director writes zeros in the remaining bytes. If the CCW count is greater than 11, only 11 bytes are written.

*Note: Indiscriminate use of the Write Home Address command can cause loss of defect-skipping information recorded at the time of manufacture.*

### **3340/3344 Home Address Area**

The home address area consists of the skip displacement (2 bytes), flag (1 byte), cylinder number (2 bytes), and head number (2 bytes). If the CCW count is greater than seven, only the first seven bytes are written. If the CCW count is less than seven but three or more, the storage director writes zeros until seven bytes are written. If the CCW count is less than three, the command is rejected.

*Note: Indiscriminate use of the Write Home Address command can cause loss of defect-skipping information recorded at the time of manufacture.*



# Write Special Home Address

0	7 8	31 32	39 40	47 48	63
Command Code	Data Address	Flags	Not Used	Count (Decimal)	
0000 1001 X'09'	Specifies the main storage location of the home address bytes	Used at the discretion of the programmer		27 - 3375 28 - 3380	

## Function

The Write Special Home Address command causes the home address area to be transferred from main storage and written on the drive. This command is valid for 3375s and 3380s only.

## Chaining Requirements

This command must have been preceded by a Define Extent or Set File Mask command allowing execution of Diagnostic commands and Write Home Address commands.

## Status

Initial status is normally zero. Channel end and device end are presented after the home address has been written.

## Description

The Write Special Home Address command is used by the Device Support Facilities program to define any new surface defects that may occur on a track. The bytes transferred by this command are used to rewrite the home address area. The home address area is formatted as follows:

3375 Bytes	3380 Bytes	Description
0-13	0-13	Skip control
14, 15	14, 15	Segment number
16, 17	16-18	Physical address
18	19	Flag
19, 20	20, 21	Cylinder number
21, 22	22, 23	Head number
23-26	24-27	Not used

The skip control, segment number, physical address, cylinder number, and head number are checked for validity. Any invalid value causes the command to be rejected and no home address is written.

After checking the validity of the home address, the storage director instructs the device to orient on index, write gap G1, and then write the home address and correction code bytes. (Bits 0 through 5 of the flag byte are reset to zero before being transferred to the device.)

If a Write Special Home Address command is the last format write in a chain, the remaining portion of the track is erased. If a command other than Write R0 is chained from Write Special Home Address, it is executed after the track is erased. Since reconnection may not occur until some time after index, the next command will not be oriented.

*Note: Use caution when using the Write Special Home Address command. The storage director does not verify the actual cylinder and head positioning of the device before writing the home address. If there was a previous error in positioning the device, the home address may be written on the wrong track. If there is a readable home address on the track, the Write Special Home Address command should be preceded by a Read or Search Home Address command to verify head positioning before the new address is written.*

# Write Record Zero

0	7 8	31 32	39 40	47 48	63
Command Code	Data Address	Flags	Not Used	Count (Decimal)	
0001 0101 X'15'	Specifies the main storage location of the R0 count, key, and data bytes	Used at the discretion of the programmer		Specifies the number of bytes in R0 count, key and data areas	

## Function

The Write Record Zero (R0) command causes the count, key, and data areas of record zero to be transferred from main storage and written on the drive.

*Note: Record zero (R0) is the first record after home address. The count field CCHHR in R0 does not have to be zero.*

## Chaining Requirements

The Write R0 command must be chained from a Write Home Address command or a Search Home Address Equal command whose argument was equal to four bytes (cylinder and head numbers) of the home address area.

The Write Record Zero command may also be chained from a Locate Record command that specified a Format Write (with search modifiers) subcommand.

## Status

Initial status is normally zero. Channel end and device end are presented after writing the data area correction code bytes.

## Description

Record 0, the track descriptor record, is always the first record on the track following the home address area. Although R0 may be used as a normal data record, it is usually reserved by the operating system to store pertinent track information. For a defective track, R0 points to an alternate track. For an alternate track, R0 points to a defective track. An unused alternate track R0 points to itself.

The first eight bytes of data transferred are the count area: cylinder number (2 bytes), head number (2 bytes), record number (1 byte), key length (1 byte), and data length (2 bytes). On a defective track, the CCHH bytes are assigned the alternate track address; on an assigned alternate, they must contain the defective track address.

The remaining data sent from main storage is written in the key and data areas as specified by the values set in the key length (KL) and data length (DL) bytes.

The count field of the CCW specifies the total number of bytes to be transferred ( $8 + KL + DL$ ). If the count is less than  $8 + KL + DL$ , zeros are written in the remainder of the record. Correction code bytes are written at the end of the count area, end of the key area, and end of the data area.

If the Write R0 command is the last format write command in a chain, the remaining portion of the track is erased. If a command other than another format write is chained from the Write R0, it is executed after the track is erased. Since reconnection may not occur until some time after index, the next command will not be oriented.

*Note: Record zero is normally written on the tracks by the disk manufacturer. The use of this command should be limited to identifying defective tracks and assigning alternate tracks. Utility programs are available to perform these functions. Proper operation with IBM operating systems requires a 0 key length and an 8-byte data field.*

# Erase

Command Code	Data Address	Flags	Not Used	Count (Decimal)
0001 0001 X'11'	Specifies the main storage location of the count, key, and data bytes	Used at the discretion of the programmer		Specifies the number of count, key and data bytes

## Function

The Erase command writes zeros on the remainder of the track.

## Chaining Requirements

The Erase command must be chained from a Write R0, Write CKD, Search ID Equal, or Search Key Equal command. The search commands must have compared equal on all bytes.

*Note: A Read Data or Read Key and Data CCW may be inserted between a Search ID Equal and the Erase command. A Read Data command may be inserted between a Search Key Equal and the Erase command.*

*On 3375 and 3380 devices, a Write Data, or Write Key and Data command may be inserted between a Search ID and Erase command; or a Write Data command may be inserted between a Search Key and Erase command.*

The Erase command may also be chained from a Write Data command that was chained from a Locate Record command that specified a Write Track subcommand.

## Status

Initial status is normally zero. Channel end and device end are presented after the correction code bytes have been written at the end of the data area.

## Description

This command is executed like a Write Count, Key, and Data command, except that zeros are written to the end of the track. Although data is transferred from the channel, it is not written on the device.

# Write Count, Key, and Data

0	7 8	31 32	39 40	47 48	63
Command Code	Data Address	Flags	Not Used	Count (Decimal)	
0001 1101 X'1D'	Specifies the main storage location of the count, key, and data bytes	Used at the discretion of the programmer		Specifies the number of bytes in the count, key and data areas	

## Function

The Write Count, Key, and Data (CKD) command causes an entire record to be transferred from the main storage and written on the drive.

## Chaining Requirements

The Write CKD command must be chained from a Write R0, Write CKD, Write CKD Next Track, Search ID Equal or Search Key Equal command. The Write CKD command may not be chained from a search command that operated on an overflow record segment. The search commands must have compared equal on all bytes of the searched field.

*Note: A Read Data or Read Key and Data CCW may be inserted between a Search ID Equal and the Write CKD command. A Read Data command may be inserted between a Search Key Equal and the Write CKD command.*

*On 3375 and 3380 devices, a Write Data, or Write Key and Data command may be inserted between a Search ID and Write CKD command; or a Write Data command may be inserted between a Search Key and Write CKD command.*

The Write CKD command may also be chained from a Locate Record command that specified a Format Write subcommand, or from a Write Data command that was chained from a Locate Record command that specified a Write Track subcommand.

## Status

Initial status is normally zero. Channel end and device end are presented after the correction code bytes have been written at the end of the data area.

# Seek Cylinder

0	7 8	31 32	39 40	47 48	63
Command Code	Data Address	Flags	Not Used	Count (Decimal)	
0000 1011 X'0B'	Specifies the main storage location of the seek address	Used at the discretion of the programmer		6	

## Function

The Seek Cylinder command transfers the seek address from the channel to the storage director. This command performs the same functions as the Seek command.

## Chaining Requirements

None.

## Status

Initial status is normally zero. Channel end and device end are presented after the seek address has been transferred. See the description below for other status conditions.

## Description

The Seek Cylinder command transfers the six-byte seek address from the channel to the storage director. The storage director saves the address to allow positioning of the access mechanism at a later time. If the seek address indicates that no access motion is required, the proper head is selected before channel end and device end status are presented.

The storage director checks the seek address for validity (see the following chart). If the seek address is not valid, channel end, device end, and unit check are presented in ending status.

The format for the seek address is:

Byte	0	1	2	3	4	5
	0	0	C	C	H	H

## Description

The count, key, and data areas of a record are transferred from main storage and written on the addressed device. The first eight bytes are the count area: record ID (5 bytes), key length (1 byte), and data length (2 bytes).

The remaining data sent from main storage is written in the key and data areas as specified by the values set in the key length (KL) and the data length (DL) bytes.

The count field of the CCW specifies the total number of bytes to be transferred ( $8 + KL + DL$ ). If the CCW count is less than  $8 + KL + DL$ , zeros are written in the remainder of the record.

Correction code bytes are written at the end of the count area, at the end of the key area, and at the end of the data area.

If the Write CKD command is the last format-write command in a chain, the remaining portion of the track is erased. If a command other than another format write is chained from the Write CKD, it is executed after the track has been erased. Since reconnection may not occur until some time after index, the next command will not be oriented.



# Write Special Count, Key, and Data

0	7 8	31 32	39 40	47 48	63
Command Code	Data Address	Flags	Not Used	Count (Decimal)	
0000 0001 X'01'	Specifies the main storage location of the count, key, and data bytes	Used at the discretion of the programmer		Specifies the number of count, key and data bytes in the record segment	

## Function

The Write Special Count, Key, and Data (CKD) command is used to format overflow records. (See the Record Overflow section of this manual.) This command is not valid for 3375s and 3380s.

## Chaining Requirements

The Write Special CKD command must be chained from a Write R0, Write CKD, Search Key Equal, or Search ID Equal command. The Write Special CKD may not be chained from a search command that operated on an overflow record segment. The search commands must have compared equal on all bytes of the searched field.

*Note: A Read Data or Read Key and Data command may be inserted between a Search ID Equal and the Write Special CKD command. A Read Data command may be inserted between a Search Key Equal and the Write Special CKD command.*

## Status

Initial status is normally zero. Channel end and device end are presented after the correction code bytes have been written at the end of the data area.

## Description

This command is executed exactly the same as a normal Write CKD command except that the storage director writes a 1 in bit position 4 of the flag byte to indicate that it is a segment of an overflow record.

All segments of an overflow record are formatted with the Write Special CKD command except the last segment. The last segment is formatted with a normal Write CKD command.

During the execution of this command, the count, key, and data areas of a record are transferred from main storage and written on the addressed device. The first eight bytes transferred are the count area: record ID (5 bytes), key length (1 byte) and data length (2 bytes).

The remaining data sent from main storage is written in the key and data area segment as specified by the values set in the key length (KL) and data length (DL) bytes.

The count field of the CCW specifies the total number of bytes to be transferred for the particular segment ( $8 + KL + DL$ ). If the CCW count is less than  $8 + KL + DL$ , zeros are written in the remainder of the segment.

Correction code bytes are written at the end of the count area, at the end of the key area, and at the end of the data area.

If the Write Special CKD command is the last format-write command in a chain, the remaining portion of the track is erased. If a command other than another format write is chained from the Write Special CKD command, it is executed after the track has been erased. Since reconnection may not occur until some time after index, the next command will not be oriented.

# Write Data

0	7 8	31 32	39 40	47 48	63
Command Code	Data Address	Flags	Not Used	Count (Decimal)	
0000 0101 X'05'	Specifies the main storage location of the data used to update a record	Used at the discretion of the programmer		Specifies the number of bytes to be written	

## Function

The Write Data command causes the specified data in main storage to be written in the data area of the selected record.

## Chaining Requirements

The Write Data command must be chained from a Search ID Equal or Search Key Equal command that compared equally on all bytes of the searched field or from a Locate Record command that specified a Write Data or Write Track subcommand.

## Status

Initial status is normally zero. Channel end and device end are presented after the correction code bytes have been written.

## Description

The Write Data command is used to perform normal record updating after track formatting. The number of bytes to be written is specified in the count field of the Write Data CCW.

If the number of bytes specified in the CCW count is less than that specified in the count area data length (DL) bytes, the storage director writes zeros in the remaining data area and then writes the correction code bytes. If the CCW count is greater than the number of bytes specified in the count area DL bytes, only the number of bytes specified in the count area DL bytes are written. The storage director then writes the correction code bytes after the data area.

# Write Key and Data

0	7 8	31 32	39 40	47 48	63
Command Code	Data Address	Flags	Not Used	Count (Decimal)	
0000 1101 X'0D'	Specifies the main storage location of the data used to update a record	Used at the discretion of the programmer		Specifies the number of bytes to be written	

## Function

The Write Key and Data command causes the specified data in main storage to be written in the key and data areas of the selected record.

## Chaining Requirements

The Write Key and Data command must be chained from a Search ID Equal command that compared equally on all bytes of the search field or from a Locate Record command that specified a Write Data subcommand.

## Status

Initial status is normally zero. Channel end and device end are presented after the correction code bytes have been written at the end of the data area.

## Description

The Write Key and Data command is used to perform normal updating of the key and data areas after track formatting. The number of bytes to be written is specified in the count field of the Write Key and Data CCW. If the number of bytes specified in the CCW count is less than that specified in the count area key length (KL) and data length (DL) bytes, the storage director writes zeros in the remaining area. If the CCW count is greater than the number of bytes specified in the KL and DL bytes, only the number of bytes specified in the KL and DL bytes are written.

Correction code bytes are written after the key and data areas.

# Write Update Data

0	7 8	31 32	39 40	47 48	63
Command Code	Data Address	Flags	Not Used	Count (Decimal)	
1000 0101 X'85'	Specifies the main storage location of the data used to update a record	Used at the discretion of the programmer		Specifies the number of bytes to be written	

## Function

The Write Update Data command causes the specified data in main storage to be written in the data area of the selected record. This command is valid only with 3880s with the speed matching buffer for the 3375 or 3380 feature.

## Chaining Requirements

A Write Update Data command must be chained from a Locate Record command that specified a Write Data subcommand or from another Write Update Data command.

## Status

Initial status is normally zero. Channel end and device end are normally presented when the data has been loaded into the buffer. If this is the last write in the Locate Record command domain, channel end and device end are presented after the data is written on the device.

## Description

The Write Update Data command is used to perform normal record updating of the data area after track formatting. The number of bytes to be written is specified in the count field of the updated record.

The Write Update Data command writes data in the first data field encountered on the track. (The 3880 maintains track orientation after the search function performed by the previous Locate Record command.) When index point is detected, head switching to the next track occurs as long as the next track is within the parameters defined by the previously executed Define Extent command. If head switching occurs, the first record on the track (R0) is passed over and data is written in the first data record on the track. The storage director automatically switches to track 0 of the next cylinder when the end of cylinder is reached.

# Write Update Key and Data

Command Code	Data Address	Flags	Not Used	Count (Decimal)
1000 1101 X'8D'	Specifies the main storage location of the data used to update a record	Used at the discretion of the programmer		Specifies the number of bytes to be written

## Function

The Write Update Key and Data command causes the specified data in main storage to be written in the key and data areas of the selected record. This command is only valid with 3880s with the speed matching buffer for the 3375 or 3380 feature.

## Chaining Requirements

A Write Update Key and Data command must be chained from a Locate Record command that specified a Write Data subcommand or from another Write Update Key and Data command.

## Status

Initial status is normally zero. Channel end and device end are presented when the data has been loaded into the buffer. If this is the last write in the Locate Record domain, channel end and device end are presented after the data is written on the device.

## Description

The Write Update Key and Data command is normally used to update the key and data areas encountered on the track. (The 3880 maintains track orientation after the search function performed by the previous Locate Record command.) When index point is detected, head switching to the next track occurs as long as the next track is within the extent defined by the previously executed Define Extent command. If head switching occurs, the first record on the track (R0) is passed over and data is written in the key and data areas of the first data record on the track. The storage director automatically switches to track 0 of the next cylinder when the end of cylinder is reached.

# Write CKD Next Track

0	7 8	31 32	39 40	47 48	63
Command Code	Data Address	Flags	Not Used	Count (Decimal)	
1001 1101 X'9D'	Specifies the main storage location of the data used to update a record	Used at the discretion of the programmer		Specifies the number of bytes to be written	

## Function

The Write CKD Next Track command combines the functions of head switching, orienting to the first record of a track, and writing the count, key, and data areas of a record on the track. This command is valid only with 3880s with the speed matching buffer for the 3375 or 3380 feature.

## Chaining Requirements

The Write CKD Next Track command must be preceded by a Locate Record command that specified a Format Write subcommand. It can only be chained from another Write CKD or Write CKD Next Track command.

## Status

Initial status is normally zero. Channel end and device end are normally presented when the data has been loaded into the buffer. If this is the last write in the Locate Record domain, channel end and device end are presented after the data is written.

## Description

Execution of a Write CKD Next Track command causes the heads to be switched to the next track (or the next cylinder, head 0, if the end of cylinder is reached). The storage director verifies that there is a record (R0) following home address, skips over this record, and writes the count, key, and data areas of the record as specified by the values set in the key length (KL) and data length (DL) bytes. Correction code bytes are written at the end of each area.

*Note: Head switching does not occur if the end of the extent, as defined in the previously executed Define Extent command, has been reached.*

# Diagnostic Sense

Command Code	Data Address	Flags	Not Used	Count (Decimal)
0100 0100 X'44'	Specifies the main storage location where the first byte of error code message accumulated during a previous Diagnostic Write command is to be transferred	Used at the discretion of the programmer		16

## Function

The Diagnostic Sense command transfers the error code message accumulated during a previous Diagnostic Write command from the storage director to main storage. This command is not valid for 3375s and 3380s.

## Chaining Requirements

The Diagnostic Sense command should be chained from a Diagnostic Write command.

## Status

Initial status is normally zero. Channel end and device end are presented after data transfer.

## Description

The execution of a Diagnostic Sense command that is chained to a Diagnostic Write command causes 16 bytes of error code information to be transferred to main storage. The error code information was accumulated during execution of the previous Diagnostic Write command. When chained to a Diagnostic Write command, the CCW count field should be set to 16.

*Note: This command is intended for maintenance purposes only. Any use other than that provided by IBM diagnostic programs may yield unpredictable results.*



# Diagnostic Load

Command Code	Data Address	Flags	Not Used	Count (Decimal)
0101 0011 X'53'	Specifies the main storage location of the control byte for the diagnostic test	Used at the discretion of the programmer		1

## Function

The Diagnostic Load command transfers one byte of control information (diagnostic program ID number) from main storage to the storage director. This command is not valid for 3375s and 3380s.

## Chaining Requirements

None.

## Status

Initial status is normally zero. Channel end and device end are presented after the diagnostic program has been transferred from the diagnostic diskette to a buffer in the storage director.

## Description

The control byte transferred by the Diagnostic Load command specifies the program ID number of the diagnostic test that is to be transferred from the diskette to the buffer.

When addressing the storage director, the address of any device attached to the storage director may be used with the Diagnostic Load command.

*Note: This command is intended for maintenance purposes only. Any use other than that provided by IBM diagnostic programs may yield unpredictable results.*

Valid Seek Address**	3330		3340 (35 MB)	3340 (70 MB)	3344 (70 MB)	3350	3375	3380		
	Models 1 or 2	Model 11						Models AA4/A04/B04 AD4/BD4 AJ4/BJ4	Models AE4/BE4	Models AK4/BK4
Bytes 0, 1 and 4 must be:	0	0	0	0	0	0	0	0	0	0
Bytes 2 and 3 are not greater than:	410	814	348*	697*	697*	559*	959*	885*	1770*	2655*
Byte 5 is not greater than:	18	18	11	11	11	29	11	14	14	14
CE cylinders are:			349	698 699	2,800 through 2,804	1,024	960	886	1771	2658
SA cylinders			350	700	2,805	1,025	961	-3***	1780 and 1781	2667 2668 2669
* Unless the file mask bit 5 is on. **All values are decimal. *** File mask bit 5 must be on.										

If access motion is required, it is not initiated until a Set Sector, read, search, write, or Space Count command is received in the same chain or until the CCW chain ends normally. If more than one Seek command is received in the CCW chain before access motion is initiated, only the last Seek command will cause access motion.

If the CCW chain ends normally and the last Seek command has not been initiated, the storage director initiates the seek after disconnecting from the channel. If the device is addressed by another command before the seek is completed, device end is not generated, but busy status is presented.

The Seek command does not have to be preceded by another CCW in order to be executed. However, if a Define Extent or Set File Mask command has been issued, the file mask must be set to allow seeks. (See the Set File Mask section of this manual.) If preceded by a Define Extent command, the seek address must also be within the defined extent. (See the Define Extent command section of this manual.)

Execution of a Seek command resets track orientation information in the storage director.

# Diagnostic Write

Command Code	Data Address	Flags	Not Used	Count (Decimal)
0111 0011 X'73'	Specifies the main storage location of the diagnostic test	Used at the discretion of the programmer		8

## Function

The Diagnostic Write command transfers 8 bytes of data from main storage to the storage director and initiates execution of the diagnostic test previously loaded by a Diagnostic Load command. This command is not valid for 3375s and 3380s.

## Chaining Requirements

The Diagnostic Write command must be preceded by a Set File Mask command which allows the execution of Diagnostic Write commands. (See the Set File Mask section of this manual.)

## Status

Initial status is normally zero. Channel end and device end are presented after the test has been transferred, run, and the results stored in a buffer in the storage director.

## Description

The diagnostic test run had previously been loaded by a Diagnostic Load command. After data transfer is complete, the test is run and a 16-byte error code is stored in a buffer in the storage director.

A subsequent Diagnostic Sense command transfers the error code to main storage.

*Note: This command is intended for maintenance purposes only. Any use other than that provided by IBM diagnostic programs may yield unpredictable results.*

# Diagnostic Control

0	7 8	31 32	39 40	47 48	63
Command Code	Data Address	Flags	Not Used	Count (Decimal)	
1111 0011 X'F3'	Specifies the main storage location of the diagnostic control parameters	Used at the discretion of the programmer			4

## Function

The Diagnostic Control command transfers four bytes of diagnostic control parameters from the channel to the storage director. This command is valid for 3330s, 3350s, and 3380s only. This command is not valid for 3380s with the speed matching buffer feature.

## Chaining Requirements

The Diagnostic Control command must be preceded by a Set File Mask command that allows the execution of diagnostic commands. If a violation of the file mask is detected, the command is rejected with channel end, device end, and unit check status.

## Status

Initial status is normally zero. Channel end and device end are presented after the parameters have been transferred from the channel.

## Description

The four bytes of diagnostic control parameters transferred by this command have the following format:

Bytes	Description
0	Subcommand
1	Subcommand modifier
2 and 3	Number of additional parameter bytes to be transferred

After transferring the four bytes, the storage director checks the validity of the subcommand code and modifiers, and that bytes 2 and 3 are set to zero. The Diagnostic Control command is terminated with channel end, device end, and unit check if invalid parameters are detected.

## Byte 0

Byte 0 specifies the following subcommands that can be executed by the storage director:

Subcommand	Hexadecimal	Binary
Locate Data Checks (Feature 3005 only)	X'01'	0000 0001
Inhibit Write	X'02'	0000 0010
Enable Write	X'08'	0000 1000

**Locate Data Checks** prevents data checks from causing a unit check or Channel Command Retry. Also, it builds a table to display the location of all data checks found in the first field read by a read CCW that has a data check. This table can be read back to the host with a Diagnostic Sense/Read command. Refer to "Diagnostic Sense/Read" on page 4-94 for more information.

*Note: Using this CCW on the address of a 3380 Model AJ4/BJ4 or AK4/BK4 causes data checks in ECC bytes to be reported.*

**Inhibit Write** inhibits all subsequent write operations by the storage director on the data paths specified by the subcommand modifiers. Any write commands that attempt a write operation on a path, after an inhibit write subcommand has been issued for that path, will be rejected with channel end, device end, and unit check status. The sense bytes associated with this unit check will indicate an equipment check and write inhibited.

*Note: Inhibit Write subcommand should not be confused with the Write Inhibit switch that is available on 3330 or 3350 devices. The latter is a physical switch located on the device.*

**Enable Write** cancels the effect of any previous Inhibit Write subcommands and allows the storage director to process all write commands normally. The subcommand modifier is not used and must be set to zero.

## Byte 1

The subcommand identification modifier byte specifies the data path associated with the Write Inhibit subcommand and has the following format:

<b>Modifier</b>		<b>Description</b>
<b>Hexadecimal</b>	<b>Binary</b>	
X'80'	1000 0000	Inhibits all write operations on the selected storage director.
X'40'	0100 0000	Inhibits all write operations on the selected channel path.
X'20'	0010 0000	Inhibits write operations to all devices associated with the selected device controller.

When a Diagnostic Control command with a subcommand identification modifier of X'40' is received, the storage director will verify whether the inhibit write function is active on any other channel path. If so, all write operations are inhibited on the selected storage director.

## Bytes 2 and 3

Bytes 2 and 3 contain the number of additional parameter bytes to be transferred from the channel to the storage director.

*Note: This command is intended for use by system error recovery programs only.*

# Diagnostic Sense/Read

0            7 8                            31 32                            39 40                            47 48                            63

Command Code	Data Address	Flags	Not Used	Count (Decimal)
1100 0100 X'C4'	Specifies the main storage location where the first byte of diagnostic information is to be transferred	Used at the discretion of the programmer		4,092 (maximum) 4,092 (3375 SMB) 5,632 (3380 SMB)

## Function

The Diagnostic Sense/Read command transfers the contents of the trace/dump buffer from the storage director to the channel.

## Chaining Requirements

A Diagnostic Sense/Read command must be chained after a read command, such as Read Home Address, Read Count, Read Data, Read Key and Data, or any other read command, if the read command was preceded by a Diagnostic Control command with an order code X'01' (Locate Data Checks.) Refer to "Diagnostic Control" on page 4-91 for more information.

## Status

Initial status is normally zero. Channel end and device end are presented after the contents of the trace/dump buffer have been transferred to the channel.

## Description

The trace/dump buffer contains information about channel interface sequences, microcode sequences, and status information that is used by the customer engineer to isolate hardware failures.

*Note: This command is intended for maintenance purposes only. Any use other than that provided by IBM diagnostic programs may yield unpredictable results.*

If a Diagnostic Control with order code X'01' (Locate Data Checks) precedes the Diagnostic Sense/Read command, 1024 bytes containing information about the location of all data checks found in the first field read by a preceding Read CCW that detected a data check.

# Channel Programs

The following channel programs are typical examples of how CCWs are arranged to format, read, and write records using a 3880 with a 3330 series disk storage, a 3340 disk storage with the RPS feature, a 3350 disk storage, a 3375 disk storage, or a 3380 disk storage. These examples do not include the system control program used to start the channel program.

## Track Formatting

**Example:** Format track X'08' on cylinder X'6A' with records R1, R2, and R3 for customer records. Assume the R0 has a key length (KL) of zero and a data length (DL) of eight bytes, and that R1, R2, and R3 have a key length of six bytes and a data length of X'0064' (100<sub>10</sub>) bytes.

The channel program is:

```

Seek
Set File Mask
Set Sector
Search ID Equal (R0)
TIC *.8
Write CKD
Write CKD
Write CKD
  
```

Seek

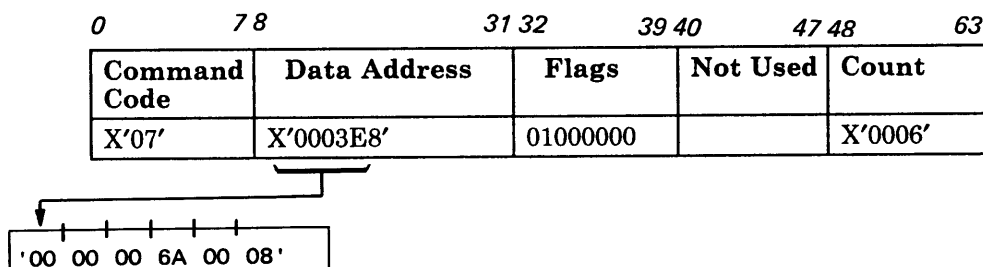

All Seek commands transfer six bytes of data from main storage (count = 6). The first two seek address bytes are always zeros, the cylinder number (X'006A') is specified in the bytes 3 and 4, and bytes 5 and 6 indicate the required head (X'0008'). The seek address is saved in the storage director.



### Set File Mask

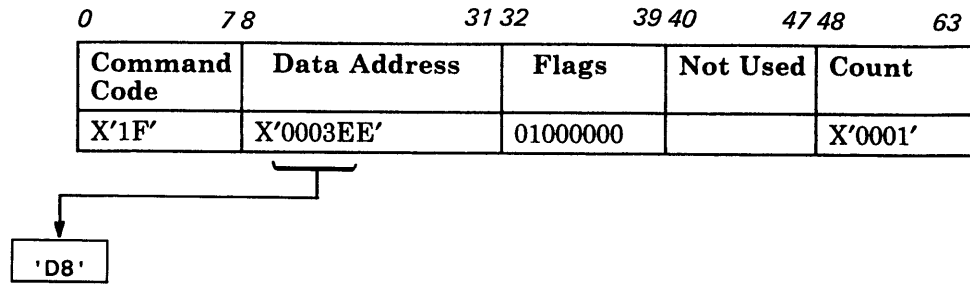

The Set File Mask command specifies the types of operations that can be performed in this channel program. The mask byte in this case (X'D8') permits format write commands and inhibits seek commands. The mask is reset to zero at the beginning of each command chain.

### Set Sector

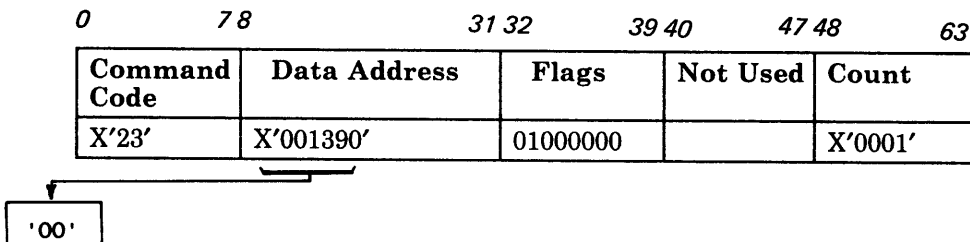

Execution of a Set Sector command with an argument of zero, orients the track to index. During the time the storage director is waiting for index, the channel is available to perform other operations. If the previous Seek command indicated that access motion was required, the access mechanism is positioned while the storage director is disconnected from the channel.

### Search ID Equal

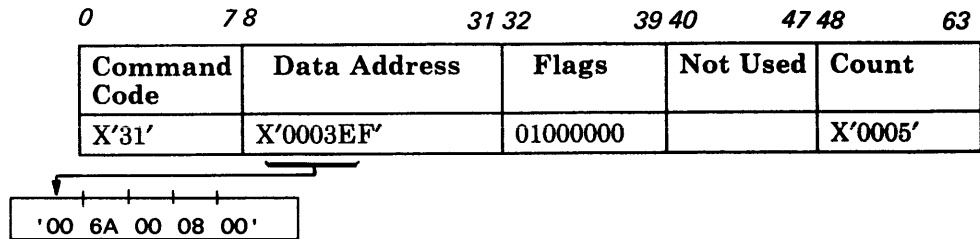

The Search ID Equal command causes the first ID found on the track to be compared with the argument. All unequal comparisons of IDs caused the 3880 to signal channel end and device end to the channel causing the TIC command (back to Search ID Equal) to be executed. When an equal comparison is found (ID of record 0), the 3880 signals channel end, device end, and status modifier to the channel. The status modifier causes the next command (TIC) to be skipped and the first Write CKD command to be executed.

### Transfer-In-Channel (TIC)

0	78	31 32	39 40	47 48	63
---	----	-------	-------	-------	----

Command Code	Data Address	Flags	Not Used	Count
X'X8'	Address of the previous command	XXXXXXXX		X'XXXX'

TIC \*8 branches back to the last command address.  
 X = positions ignored.

## Write CKD

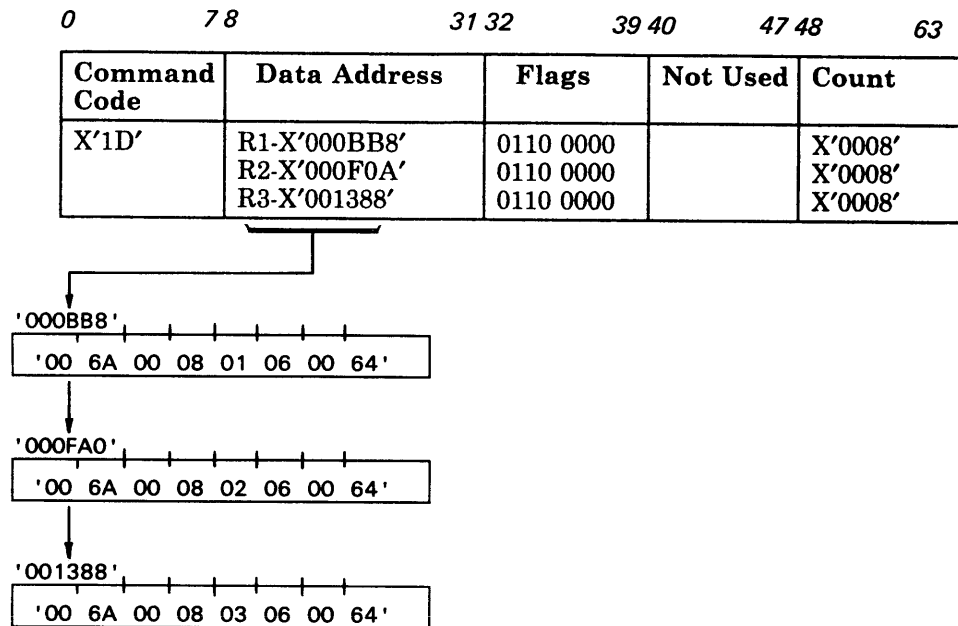

Execution of the Write CKD commands causes a count area, key area (if not zero), and the data area with the length specified by the DL bytes, to be written on the disk.

The main storage locations specified in the data address are coded with the cylinder number, head number, record number, key length, and data length of each record. Since the KL = X'06', a key area of six bytes is created. The data length specified is X'0064' (100<sub>10</sub>) bytes. Although the CCW bytes count is only eight, and the channel byte count goes to zero after eight bytes are written, the storage director is committed to write a key area six bytes long and a data area 100 bytes long. Therefore, the storage director inserts zeros in the applicable track positions until the byte count reaches zero.

The difference in the channel byte count and the storage director byte count causes an incorrect length indication, so the SLI flag (bit 34) is set in the CCWs.

In this example, six bytes of zeros are recorded in the key area and followed by the ECC bytes, a gap, 100 bytes of zeros, and more ECC bytes. The data that replaces the zeros can be recorded in the key and data areas at a later time with the following CCW sequence:

```
Set Sector
Search ID Equal (R1)
TIC *-8
Write KD
Search ID Equal (R2)
```

# Seek Head

0	7 8	31 32	39 40	47 48	63
Command Code	Data Address	Flags	Not Used	Count (Decimal)	
0001 1011 X'1B'	Specifies the main storage location of the seek address	Used at the discretion of the programmer		6	

## Function

The Seek Head command transfers the seek address from the channel to the storage director.

## Chaining Requirements

None.

## Status

Initial status is normally zero. Channel end and device end are presented after the transfer of the seek address.

## Description

The Seek Head command transfers the six-byte seek address from the channel to the storage director. The storage director selects the drive and the proper head. Regardless of the value of the seek address cylinder bytes (bytes 2 and 3), no access motion is initiated.

*Note: Although the cylinder bytes are not used, they must contain a valid address.*

The storage director checks all six bytes of the seek address for validity (see the following chart). If the seek address is not valid, channel end, device end, and unit check are presented in ending status.

The format for the seek address is:

Byte	0	1	2	3	4	5
	0	0	C	C	H	H

## Update Write

Example: Update Frank Smith's record. Assume that the disk is organized by key areas. Each key area contains an employee number. Frank Smith's number is 656151. This number is located in cylinder X'0C', head X'04'. The key areas are six bytes long and the data areas are X'64' (100<sub>10</sub>) bytes long.

The channel program is:

```

Seek
Set File Mask
Search Key Equal
TIC *-8
Write Data
  
```

**Seek**

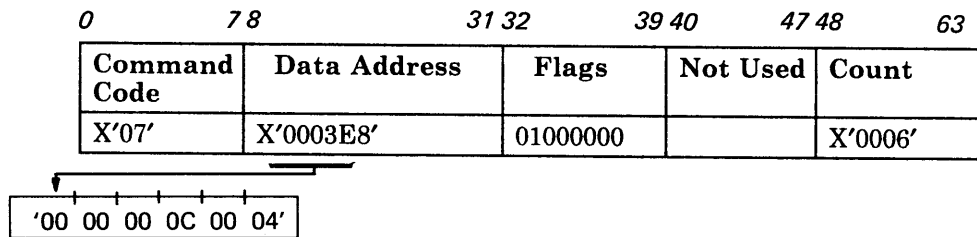

As explained in the track formatting example, the Seek command saves the seek address for later execution.

### Set File Mask

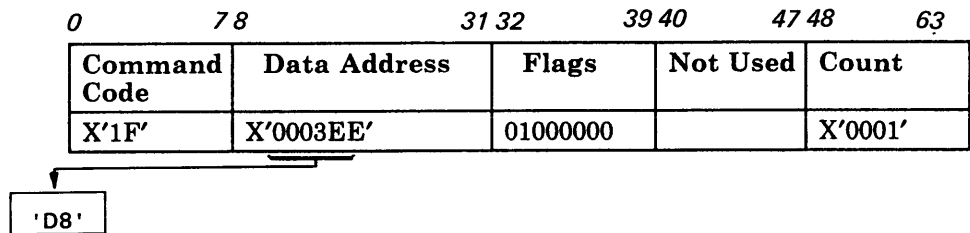

The Set File Mask command specifies the types of operations that can be performed in this channel program. The mask byte in this case (X'D8') permits all write commands and inhibits all seek commands. The mask is reset to zero at the beginning of each command chain.

### Set Sector

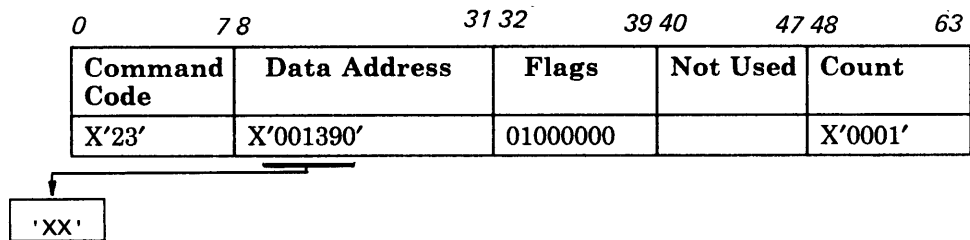

Execution of the Set Sector command transfers the sector number of the record specified in the following search key command to the storage director (X'XX' = sector number.) If the previous Seek command indicated access motion was required, the access mechanism is moved to the proper location before the sector positioning is accomplished.

### Search Key Equal

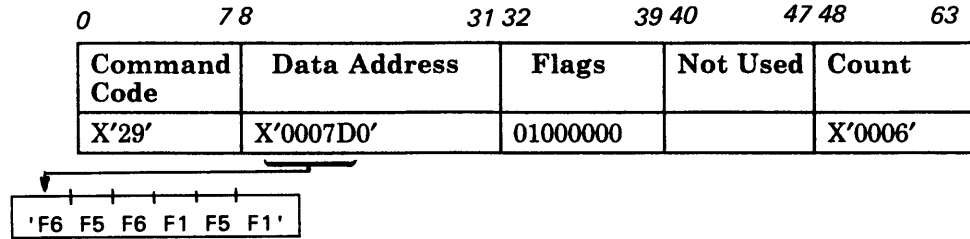

After locating the correct cylinder and track, Frank Smith's record must be found. Since the disk is organized by keys, a Search Key Equal command is executed. This causes the storage director to search the key area of the next record on the track. If the key is not equal to Frank Smith's number (main storage locations X'07D0' through X'07D5'), the storage director signals channel end and device end to the channel and the TIC command (return to Search Key Equal) is executed. Normally the first record encountered is the correct record and the TIC is not executed. This continues until the correct record is found. The storage director then sends channels end, device end, and status modifier to the channel. The status modifier bit in the status byte causes the channel to skip the next command (TIC) and execute the Write Data command.



### Transfer-in-Channel (TIC)

0	7 8	31 32	39 40	47 48	63
<b>Command Code</b>	<b>Data Address</b>	<b>Flags</b>	<b>Not Used</b>	<b>Count</b>	
X'X8'	Address of the previous command	XXXXXXXX		X'XXXX'	

TIC \*-8 branches back to the Search Key Equal command.  
 X = positions ignored.

### Write Data

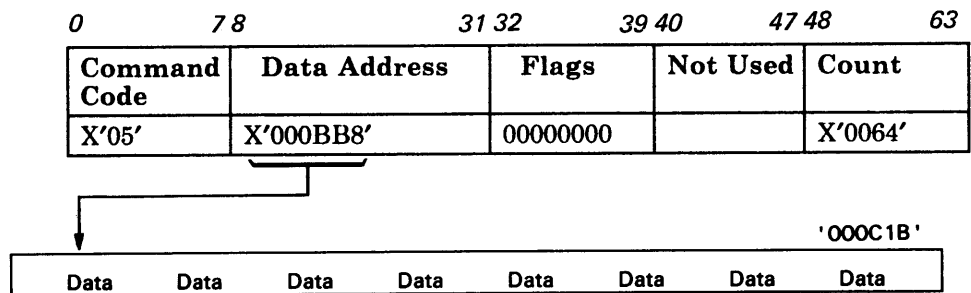

The Write Data command transfers the data to update Frank Smith's payroll record from main storage locations X'0BB8' through X'0C1B' to the disk.

If Frank Smith's payroll record is not at cylinder X'0C', head X'04', the program loops between the Search Key Equal and the TIC until every key on the track has been searched. The storage director then signals unit check to the channel. A subsequent Sense command indicates no record found.

The data just written could be verified by chaining the following CCWs to the Write Data command:

Read Sector	Store sector address
Set Sector	Locate sector
Search Key Equal	Locate record
TIC *-8	
Read Data	Verify data

## Read

**Example:** Find and read Joe Brown's insurance policy number. Assume that the 3330 disk is organized by ID (no keys). Joe Brown's employee number is 12341. The data length of each record is X'00AA' ( $170_{10}$ ) bytes. His policy number is in the data area.

*Note: If 3340s, 3350s, 3375s, or 3380s are attached, the only difference would be the figures taken from the record capacity chart. The procedure remains the same.*

The 3330 record capacity chart shows that forty-three 170-byte records can be written on the track. Since the disk is organized by IDs (Joe Brown's = 12341), the track and record location can be found by dividing the ID by the number of records per track. In this case:

$$12341/43 = 287_{10} \text{ (add 1 to the remainder to establish the address)}$$

Thus, Joe Brown's ID is  $287_{10}$  tracks from the beginning of the data set. There is no remainder, so the first record on the track is Joe Brown's. The CC HH R for the Seek command is then determined by converting the  $287_{10}$  tracks to cylinders and adding the results to the beginning of the data set.

	CYLINDER	TRACK	RECORD	C	C	H	H	R
Starting Address	10	00	0	00	0A	00	00	00
Displacement*	15	02	1	00	0F	00	02	01
Result	25	02	1	00	19	00	02	01

\*Determined by dividing 287 by 19.

The channel program is:

Seek  
 Set File Mask  
 Set Sector  
 Search ID Equal  
 TIC \*-8  
 Read Data

**Seek**

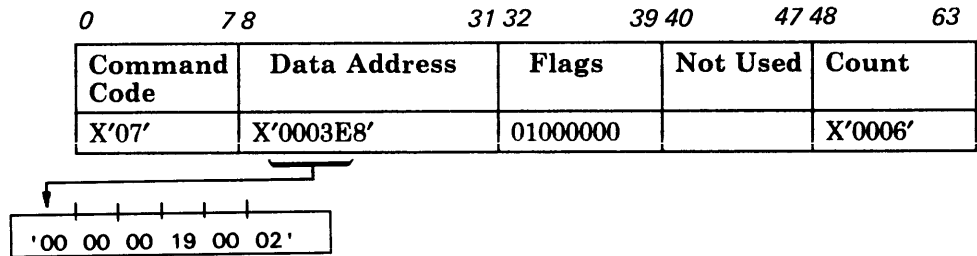

The Seek command is executed as explained in the Update Write example and moves the access mechanism cylinder X'19' ( $25_{10}$ ) and select head X'02'.

### Set File Mask

0	7 8	31 32	39 40	47 48	63
Command Code	Data Address	Flags	Not Used	Count	
X'1F'	X'001000'	01000000			X'0001'

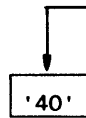

The Set File Mask command specifies the types of operations that can be performed in the channel program. The mask byte in this case X'40' permits all seek commands and inhibits all write commands.

### Set Sector

0	7 8	31 32	39 40	47 48	63
Command Code	Data Address	Flags	Not Used	Count	
X'23'	X'001390'	01000000			X'0001'



Execution of the Set Sector command transfers the sector number of the record specified in the following Search ID command to be transferred to the storage director. (X'XX' = sector number.)

### Search ID Equal

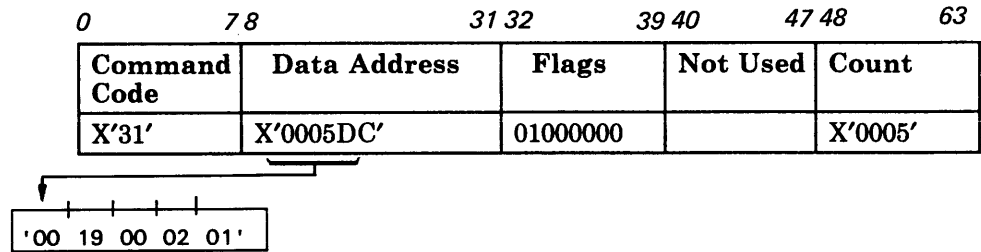

The Search ID Equal causes the first ID found on the track to be compared with Joe Brown's ID. All unequal comparisons of IDs cause the storage director signal channel end and device end to the channel and the TIC (back to Search ID Equal) is executed. Normally, the first record encountered is the correct record and the TIC is not executed. When an equal compare is found (ID of record 1), the storage director signals channel end, device end, and status modifier to the channel. Status modifier causes the next command (TIC) to be skipped and the Read Data command to be executed.

### Transfer-in-Channel (TIC)

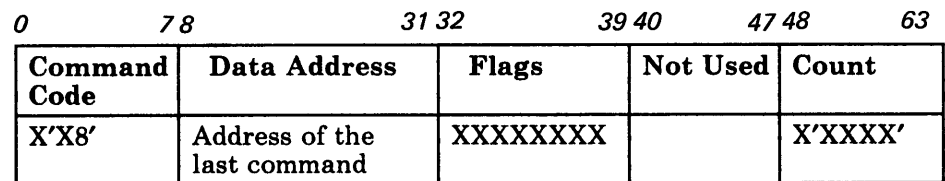

TIC \*-8 branches back to the Search ID Equal command.  
 X = positions ignored.

### Read Data

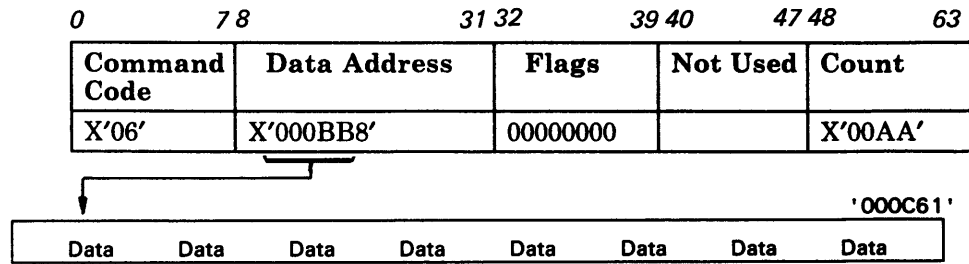

Execution of the Read Data command causes the data area containing Joe Brown's insurance policy number to be read into main storage at locations X'0BB8' through X'0C61'.

# Channel Programs – 3880 with Speed Matching Buffer for 3375 or 3380

The following channel programs are examples of how the Define Extent command, Locate Record command, and data transfer CCWs are arranged to format, update, and read records on a 3375 or 3380 that is attached to a 3880 with the speed matching buffer for 3375 or 3380 Models AA4 and A4.

## Track Formatting

**Example:** Format track X'08' in cylinder X'006A' with records R1, R2, R3, and an end-of-file record. The three data records (R1, R2, R3) all have a key length of 6 bytes and a data length of 100 (X'64') bytes. The end-of-file record consists of a count field only, with the key and data length in the count field set to X'00'.

The channel program is:

```
Define Extent
Locate Record
Write CKD
Write CKD
Write CKD
```

### Define Extent

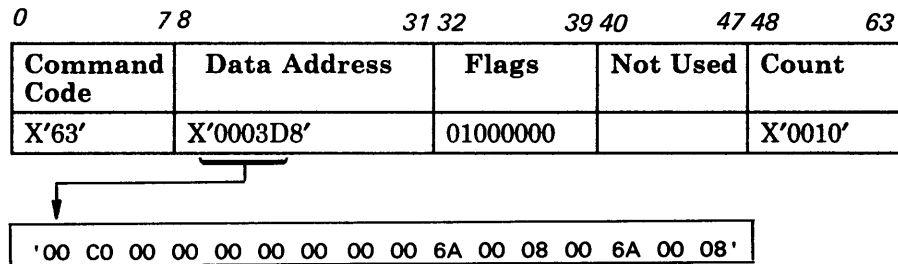

The Define Extent command transfers a 16-byte parameter list from main storage to the storage director. The parameter list has the following format and content:

**Byte 0** is the file mask. X'00' permits format write operations.

**Byte 1** must be X'C0' to indicate that this is a CKD Define Extent (rather than a Fixed Block Define Extent).

**Bytes 2 and 3** are the block size (X'0000'). The block size is not specified by this Define Extent command. The size of the records to be written must be specified by either Define Extent or Locate Record. Therefore, in this example, the transfer length factor (bytes 14-15) in the Locate Record parameter list must specify the record size.

Valid Seek Address**	3330		3340 (35 MB)	3340 (70 MB)	3344 (70 MB)	3350	3375	3380		
	Models 1 or 2	Model 11						Models AA4/A04/B04 AD4/BD4 AJ4/BJ4	Models AE4/BE4	Models AK4/AK4
Bytes 0, 1 and 4 must be:	0	0	0	0	0	0	0	0	0	0
Bytes 2 and 3 are not greater than:	410	814	348*	697*	697*	559*	959*	885*	1770*	2655*
Byte 5 is not greater than:	18	18	11	11	11	29	11	14	14	14
CE cylinders are:			349	698 699	2,800 through 2,804	1,024	960	886	1771	2658
SA cylinders			350	700	2,805	1,025	961	-3***	1780 and 1781	2667 2668 2669
* Unless the file mask bit 5 is on. **All values are decimal. *** File mask bit 5 must be on.										

If the 3380 AJ4/AK4 Attachment (Feature 3005) is installed, the Seek Head command must be preceded by one of the following commands:

- Seek
- Seek cylinder
- Read IPL
- Recalibrate
- Locate record.

If the 3380 AJ4/AK4 Attachment (Feature 3005) is not installed, the Seek Head command does not have to be preceded by another CCW in order to be executed. However, if a Define Extent or a Set File Mask command has been issued, the file mask must be set to allow Seek Head commands. (See "Set File Mask" on page 4-13.) If preceded by a Define Extent command, the seek address must also be within the defined extent. (See "Define Extent" on page 4-23.)

Execution of a Seek Head command resets track orientation information in the storage director.



Bytes 4 through 7 must contain zeros.

Bytes 8 through 15 define an extent that begins and ends with track X'006A 0008'. If the channel program attempts to access a track that is outside the defined extent, it will be terminated with a file protect error.

### Locate Record

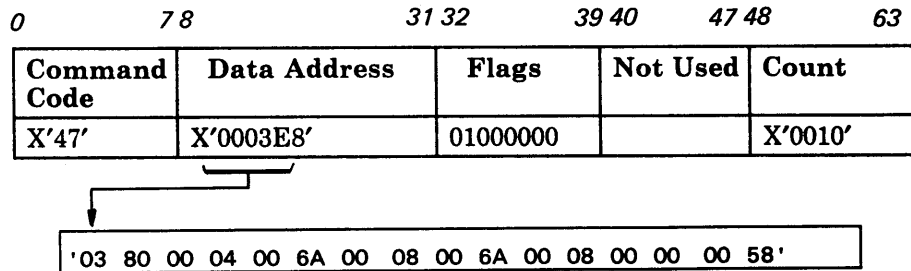

The Locate Record command transfers a 16-byte parameter list from main storage to the storage director. The parameter list has the following format and content:

**Byte 0** X'03' specifies that a format write operation is to be performed.

**Byte 1** X'80' specifies that bytes 14 and 15 contain a transfer length factor (TLF).

**Byte 2** must always be zero.

**Byte 3** specifies the number of records to be written (X'04'). Four Write CKD CCWs must follow Locate Record.

**Bytes 4 through 7** specify the seek address (X'006A 0008'). A seek to cylinder X'006A' head X'0008' will be performed before any access to the data on the device is started.

**Bytes 8 through 12** specify the search argument (X'006A 0008 00'). A successful search for record X'00' on track X'006A 0008' must be completed before any data is written *on the device*.

The storage director assumes that the search operation will be successful. One or more of the Write CKD commands may be executed, and the data will be transferred to the buffer before the search operation is started.

**Byte 13** indicates that the device is to be positioned to sector X'00' before the search operation is started.

**Bytes 14 and 15** contain a transfer length factor of X'0058' (88<sub>10</sub>). The transfer length factor is a number which, when multiplied by the record count in byte 3, gives the total number of bytes to be transferred *to the device* by the execution of the Write CKD CCWs that follow the Locate Record command.

In this case, the first three Write CKD commands will transfer an eight-byte count field, and the records will be formatted with a six-byte key field and a 100-byte data field ( $8 + 6 + 100 = 114$ ). The fourth record (the end-of-file record) will be formatted as an eight-byte count field, with no key and data fields. Each write CCW will transfer only the eight-byte count field to the storage director. The count field specifies the length of the key and data fields. The storage director will generate 106 bytes of zeros to fill out the key and data fields that are transferred to the device for the three data records. No fill is required for the end-of-file record, since it consists only of a count field. Note that the correct value for the TLF is not the same as the number of bytes transferred from main storage to the storage director. Since the records are not all the same size, the TLF is calculated by summing the number of bytes to be written on the device and dividing the total by the number of Write CKD CCWs (four). In this case, the TLF is 88 (X'58'). This is derived by adding the length of the three data records (114 each) and the length of the end-of-file record (8) for a total of 350 [ $8 + (3 \times 114)$ ] and dividing by 4. The final result contains a fraction, and is rounded high.

After the parameters have been checked for validity, the storage director performs a seek to cylinder X'006A', head X'0008' and positions the device to sector X'00'. The storage director disconnects from the channel during the seek and set sector operations.

If the maximum data rate capability of the channel is equal to, or greater than that of the device, the storage director reconnects to the channel when the device is positioned to sector X'00'. If the sector value had been X'FF' ( $255_{10}$ ), the storage director would reconnect to the channel when the seek operation was complete.

If the maximum data rate capability of the channel is less than the device (speed matching case), the storage director determines the total number of bytes to be written by multiplying the TLF (X'0058') by the record count (X'04'). It then calculates the amount of lead time (head start) required to compensate for the difference in channel and device speeds, and reconnects to the channel early to begin executing the Write CKD CCWs. The search ID operation for record X'00' is started after the device is positioned to sector X'00'.

**Write CKD**

0	7 8	31 32	39 40	47 48	63
Command Code	Data Address	Flags	Not Used	Count	Count
X'1D'	R1-X'000BB8'	01100000			X'0008'
X'1D'	R2-X'000FA0'	01100000			X'0010'
X'1D'	R3-X'001388'	01100000			X'0010'
X'1D'	R4-X'001770'	00100000			X'0010'

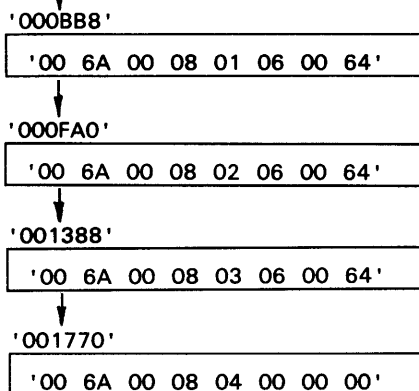

Execution of the Write CKD commands causes a count area, key area (if not zero), and the data area with the length specified by the DL bytes, to be written on the disk.

The main storage locations specified in the data address are coded with the cylinder number, head number, record number, key length, and data length of each record. In the first three count fields the KL = X'06', which creates key areas of six bytes. The data length specified is X'0064' (100<sub>10</sub>) bytes. Although the CCW byte count is only eight, and the channel byte count goes to zero after eight bytes are written, the storage director is committed to write a key area six bytes long and a data area 100 bytes long. Therefore, the storage director inserts zeros in the applicable track positions until the byte count reaches zero.

The difference in the channel byte count and the storage director byte count causes an incorrect length indication, so the SLI flag (bit 34) is set in the CCWs.

In this example, six bytes of zeros are recorded in the key area and followed by the ECC bytes, a gap, 100 bytes of zeros, and more ECC bytes. The data that replaces the zeros can be recorded in the key and data areas at a later time with the following CCW sequence:

- Define Extent
- Locate Record
- Write KD
- Write KD
- Write KD

## Update Write

The fourth data area is for the end-of-file record. In this count field, the key and data length are set to zero, and the count field is the entire record. No key or data field is written on the device.

Example: Assume track X'08' in cylinder X'006A' has been formatted with records R1, R2, and R3, and that each record has a key length of six bytes and a data length of X'64' (100<sub>10</sub>) bytes. Update the contents of the data fields of records R2 and R3.

The channel program is:

```

Define Extent
Locate Record
Write Update Data
Write Update Data.

```

### Define Extent

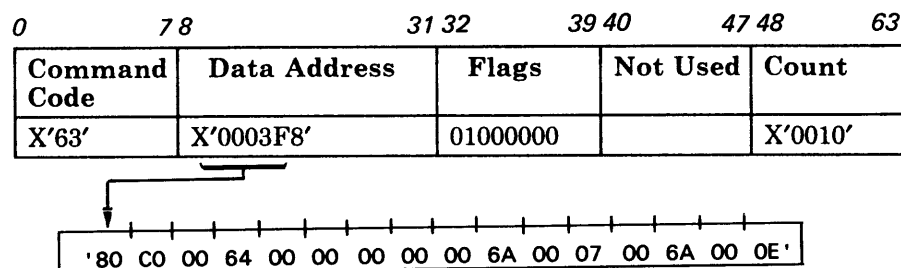

The Define Extent command transfers a 16-byte parameter list from main storage to the storage director. The parameter list has the following format and content:

**Byte 0** is the file mask. X'80' permits update write operations and inhibits format write operations.

**Byte 1** must be X'C0' to indicate that this is a CKD Define Extent (rather than a Fixed Block Define Extent).

**Bytes 2 and 3** specify the number of bytes to be written to the device by each Write Update Data CCW that follows the Locate Record. In this case, X'0064' (100<sub>10</sub>). If the key field were to be written also, the proper value would be X'6A' (106<sub>10</sub>) which is the sum of the key length and the data length.

**Bytes 4 through 7** must contain zeros.

**Bytes 8 through 15** define an extent that begins with track X'006A 0007' and continues through track X'006A 000E'. If the channel program attempts to access a track that is outside the defined extent, it will be terminated with a file protect error.

## Locate Record

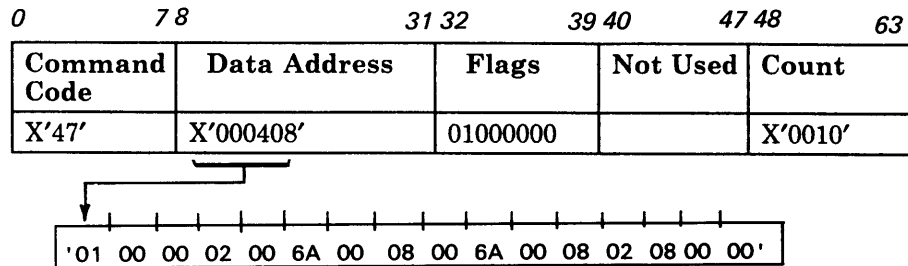

The Locate Record command transfers a 16-byte parameter list from main storage to the storage director. The parameter list has the following format and content:

**Byte 0 (X'01')** specifies that an update write operation is to be performed.

**Byte 1 (X'00')** specifies that bytes 14 and 15 do not contain a transfer length factor. The transfer length factor is not required because Define Extent specified the amount of data to be transferred to the device by the execution of each write CCW that follows the Locate Record.

**Byte 2** must always be zero.

**Byte 3** specifies the number of records to be written (X'02'). Two Write Update Data CCWs must follow the Locate Record. If the key fields were to be updated also, two Write Update Key and Data CCWs would be used.

**Bytes 4 through 7** specify the seek address (X'006A 0008'). A seek to cylinder X'006A' head X'0008' will be performed before any access to the data on the device is started.

**Bytes 8 through 12** specify the search argument (X'006A 0008 02'). A successful search for record X'02' on track X'006A 0008' must be completed before any data is written *on the device*.

The storage director assumes that the search operation will be successful. One or more of the Write Update Data commands may be executed (and the data transferred to the storage buffer) before the search operation is started.

**Byte 13** indicates that the device is to be positioned to sector X'08' before the search operation is started.

**Bytes 14 and 15** must be X'0000' when bit 0 of byte 1 is X'0'.

After the parameters have been checked for validity, the storage director performs a seek to cylinder X'006A', head X'0008' and positions the device to sector X'08'. The storage director disconnects from the channel during the seek and set sector operations.

If the maximum data rate capability of the channel is equal to or greater than the device, the storage director reconnects to the channel when the device is positioned to sector (X'08'). (If the sector value had been X'FF' (255<sub>10</sub>), the storage director would reconnect to the channel when the seek operation is complete.)

If the maximum data rate capability of the channel is less than that of the device (speed matching case), the storage director determines the total number of bytes to be written by multiplying the block size (X'0064') times the record count (X'02'). It then calculates the amount of lead time (head start) that is required to compensate for the difference in channel and device speeds, and reconnects to the channel early to begin the execution of the Write Update Data CCWs. The search ID operation for record X'02' is started after the device is positioned to sector X'08'.

#### Write Update Data

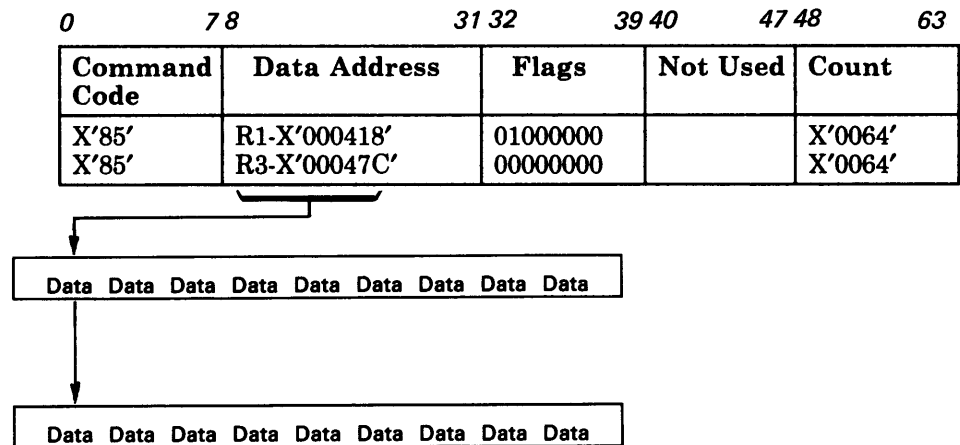

## Read

Example: Read records R1 and R2 from track X'0E' in cylinder X'007F'. Both records have a key length of 8 and a data length of X'64' (100<sub>10</sub>) bytes.

The channel program is:

```
Define Extent
Locate Record
Read Key and Data
Read Data.
```

### Define Extent

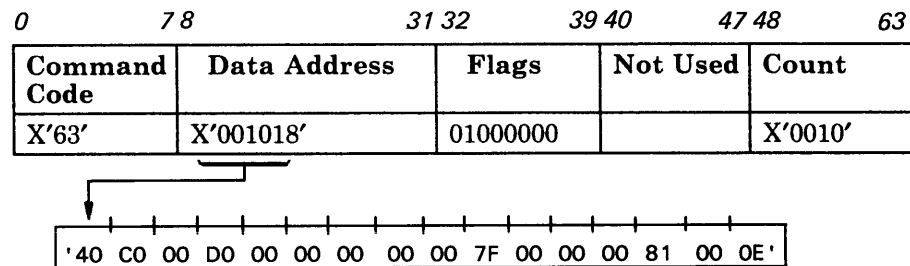

The Define Extent command transfers a 16-byte parameter list from main storage to the storage director. The parameter list has the following format and content:

**Byte 0** is the file mask. X'40' inhibits all write operations.

**Byte 1** must be X'C0' to indicate that this is a CKD Define Extent (rather than a Fixed Block Define Extent).

**Bytes 2 and 3** specify the maximum number of bytes to be transferred from any single record, X'006C' (108<sub>10</sub>). This is the sum of the key and data field lengths for record 1.

**Bytes 4 through 7** must contain zeros.

**Bytes 8 through 15** define an extent that begins with track X'007F 0000' and continues through track X'0081 000E'. If the channel program attempts to access a track that is outside the defined extent, it will be terminated with a file protect error.

## Locate Record

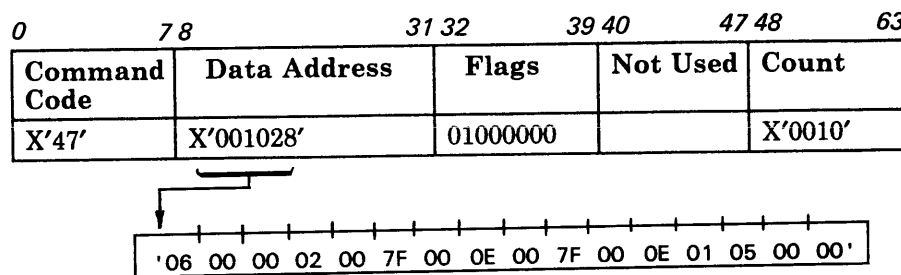

The Locate Record command transfers a 16-byte parameter list from main storage to the storage director. The parameter list has the following format and content:

**Byte 0** (X'06'). specifies that a read operation is to be performed.

**Byte 1** (X'00') specifies that bytes 14 and 15 do not contain a transfer length factor. The transfer length factor is not required because the Define Extent specified the maximum number of bytes to be transferred from any single record.

**Byte 2** must always be zero.

**Byte 3** specifies the number of records to be read (X'02'). The Locate Record must be followed by a sequence of read type CCWs that will operate on two records; for example, Read KD, Read Data; or Read Count, Read Data, Read CKD; and so on.

**Bytes 4 through 7** specify the seek address (X'007F 000E'). A seek to cylinder X'007F', head X'000E' will be performed before any access to data on the device is started.

**Bytes 8 through 12** specify the search argument (X'007F 000E 01'). A successful search for record X'01' on track X'007F 000E' must be completed before any data is read from the device.

**Byte 13** specifies the sector value (X'05') to be used to position the device before starting the search operation.

**Bytes 14 and 15** must be X'0000' when bit 0 of byte 1 is X'0'.

After the parameters have been checked for validity, the storage director performs a seek to cylinder X'007F', head X'000E' and positions the device to sector X'05'. The storage director disconnects from the channel during the seek and set sector operations and reconnects to the channel when the device is positioned to sector X'05'. If the sector value had been X'FF' ( $255_{10}$ ), the storage director would reconnect to the channel when the seek operation was complete.



## Read

0	78	31 32	39 40	47 48	63
Command Code	Data Address	Flags	Not Used	Count	
X'0E' X'06'	R1-X'001038' R2-X'001108'	01000000 00000000		X'006C' X'0064'	

Execution of the Read Key and Data, and Read Data commands causes the specified key and data areas to be read and transferred to the channel. Read operations operate the same on both fast and slow channels.

## Space Count

Command Code	Data Address	Flags	Not Used	Count (Decimal)
0000 1111 X'0F'	Specifies the main storage location of the key and data lengths of the record to be recovered	Used at the discretion of the programmer		3

### Function

The Space Count command provides a means of bypassing a defective count area.

### Chaining Requirements

The Space Count command cannot be chained from a Write Home Address, Write R0, Write CKD, Write Special CKD, or Erase command. It cannot be followed by any type of write command, Set File Mask, Read IPL, Device Reserve, or Device Release command in the same chain.

### Status

Initial status is normally zero. See the description below for ending status presentation.

### Description

The Space Count command is used for data recovery. It causes the count area of a track in the cache or on the addressed device to be bypassed.

The Space Count command is used:

1. When the Space Count command is chained from a read, search, write or Space Count command, the track has already been located in the cache or is only on DASD. (The previous command required track orientation.) The storage director:
  - a. Orients at the start of the next count area (including R0).
  - b. Spaces over the count area while accepting the three bytes of data from the channel.

- c. Sets an end of count area internal orientation indicator.
- d. Presents channel end and device end to the channel.

*Note: If the track is flagged as defective, a Space Count command should always follow a Search ID Equal command to provide consistent results.*

Command chain (A) may be used to recover key and data areas of record (N≠0). Command chain (B) may be used to recover record N + 1.

(A) Set Sector	(B) Set Sector
Search ID Equal	Search ID Equal
(record N-1)	(record N-1)
TIC*-8	TIC*-8
Space Count**	Space Count**
Read KD	Read CKD

\* Transfers to the TIC command's address, minus 8.

\*\* Must specify correct key and data lengths or a data check will occur.

2. When the command is not chained from a read, write, search, or Space Count command, the storage director:
  - a. Searches for index.
  - b. Clocks through gap 1, home address and gap 2.
  - c. Spaces over the R0 count area while accepting 3 bytes of data from the channel.
  - d. Sets end-of-count area internal orientation state indicator.
  - e. Presents channel end and device end to the channel.

When the count field of R0 is defective, Space Count may be followed by a Read Key and Data command that recovers or bypasses a bad R0 count area or Space Count may be followed by a Read CKD that reads R1.

The three bytes of data transferred from the channel are used as the key length (first byte) and the data length (last two bytes). If the CCW count is greater than 3, only three bytes are transferred. If the CCW count is less than 3, the number of bytes specified is transferred and a value of zero is assumed for bytes not transferred.

# Set File Mask

Command Code	Data Address	Flags	Not Used	Count (Decimal)
0001 1111 X'1F'	Specifies the main storage location of the mask byte	Used at the discretion of the programmer		1

## Function

The Set File Mask command transfers one byte of data (the mask byte) from main storage to the storage director.

## Chaining Requirements

The Set File Mask command cannot be issued more than once in the same CCW chain and cannot follow a Space Count or Define Extent command in the same chain.

## Status

Initial status is normally zero. Channel end and device end are presented after the mask byte has been transferred to the storage director.

## Description

The mask byte transferred by this command defines the write and seek operations that can be used in the CCW chain and defines command retry-PCI interaction. Figure 4-2 on page 4-14 describes the significance of each bit in the mask.

Any attempted violations of the file mask cause unit check status to be presented to the channel.

The mask is reset to all zeros at the end of the CCW chain or by a system or selective reset. Therefore, a CCW chain that does not contain a Set File Mask command permits the program to execute all seek and write commands except Write Home Address, Write R0, Write Special Home Address, and Diagnostic Write.

Execution of a Set File Mask command resets track orientation information in the storage director.

Bits 0 and 1	Function
00	Inhibits Write Home Address and Write R0 commands.
01	Inhibits all write commands.
10	Inhibits all format write commands.
11	Permits all write commands.
Bit 2 must be zero or unit check, channel end, and device end are presented in ending status.	
Bits 3 and 4	Function
00	Permits all seek commands.
01	Permits Seek Cylinder and Seek Head commands.
10	Permits Seek Head commands.
11	Inhibits all seek commands and head switching.
Bits 5 and 6 with Feature 3005	Function
00	A channel program executing with normal access authorization may not access diagnostic or device support tracks.
01	Channel programs executing with device support access authorization can access all tracks in all track groups
10	For 3380 Models A04, AA4/B04 , this bit inhibits retry of data checks in the count, key, and data areas of any record other than home address.  For 3380 Models AD4 and AE4, following a Set File Mask command with a diagnostic authorization, channel programs may only seek to the diagnostic and device support tracks. See note 1.  For 3380 Models AJ4 and AK4, diagnostic authorization access restricts access to the CE tracks only, regardless of whether the seek precedes or follows the Set File Mask.
11	Similar to bit 01, except that retry and correction of data checks is inhibited except during the execution of read commands other than Read Home Address, Diagnostic Read Home Address, and all Search operations.
Bits 5 and 6 without Feature 3005	Function
0	Inhibits Write Special Home Address, Read Special Home Address and seeks to CE and SA tracks.

**Figure 4-2. Description of Set File Mask Bits**

1	Permits Write Special Home Address, Read Special Home Address and seeks to CE and SA tracks. For 3380s, this bit inhibits retry of data checks in the count, key and data areas of any record other than home address. For 3375s, this bit inhibits retry of data checks in all areas of all records including home address.
Bit 6 must be zero or unit check, channel end, device end and is presented in ending status.	
Bit 7 See note 2	Function
0	Not PCI fetch mode.
1	PCI fetch mode. The storage director presents unit check if command retry is used to recover from ECC uncorrectable errors.

*Notes:*

1. *For 3380 Models AE4 after a Set File Mask with diagnostic authorization is issued, data transfer is not restricted to the Diagnostic and Device Support range. If a Seek to a non-diagnostic or Device Support Track is performed before the File Mask with diagnostic authorization is issued, the data transfer on that track will not be inhibited.*
2. *Bit 7 applies to 3330, 3350, 3375, and 3380 devices only.*

# Set Sector

Command Code	Data Address	Flags	Not Used	Count (Decimal)
0010 0011 X'23'	Specifies the main storage location of the sector argument	Used at the discretion of the programmer		1

## Function

The Set Sector command transfers one byte of information (a relative angular track position) from main storage to the storage director.

## Chaining Requirements

None.

## Status

Initial status is normally zero. Channel end is presented after a valid angular position argument is received. Device end is presented when the desired angular position is reached.

## Description

The Set Sector command, used on block multiplexer channels, allows the storage director to disconnect from the channel during rotational delay.

The storage director checks the byte transferred by the Set Sector command for validity:

<b>3330</b>	<b>3340</b>		
<b>3350</b>	<b>3344</b>	<b>3375</b>	<b>3380</b>
0-127	0-63	0-195	0-221
or	or	or	or
255	255	255	255

If the argument is not valid, the command is not executed. Channel end, device end, and unit check are presented as ending status.

If the Set Sector command is executed with an argument of 255, the storage director presents channel end and device end as ending status. No positioning operation is performed.

If the Set Sector command is executed with an argument of zero, the storage director attempts reconnection just before index.

All valid Set Sector arguments, except 255, are adjusted by the storage director to compensate for channel reselection delay.

If a 3340 without rotational position sensing (RPS) is addressed, channel end and device end are presented in initial status. No operation is performed.

Execution of Set Sector resets orientation information in the storage director.

The Set Sector command does not guarantee record orientation. The search commands must still be used for this function.

Indiscriminate use of the Set Sector command with multitrack search may result in missing the desired record. A Set Sector (sector 0), Read Home Address and search multitrack sequence will avoid this problem.

See the Rotational Position Sensing section of this manual for additional information on the use of the Set Sector command.



# Restore

Command Code	Data Address	Flags	Not Used	Count (Decimal)
0001 0111 X'17'	Not checked for validity, should not exceed addressing capacity	Used at the discretion of the programmer		Must be nonzero to avoid program check

## Function

The Restore command causes no action at the addressed device.

## Chaining Requirements

None.

## Status

Initial status is normally zero. Channel end and device end are presented as ending status immediately after initial status.

## Description

The Restore command causes no action to be performed at the addressed device. It is maintained primarily for compatibility with other IBM direct access storage devices.

Execution of a Restore command resets track orientation information in the storage director.

# Suspend Multipath Reconnection

0	7 8	31 32	39 40	47 48	63
Command Code	Data Address	Flags	Not Used	Count (Decimal)	
0101 1011 X'5B'	Ignored	Used at the discretion of the programmer		Must be nonzero to avoid program check	

## Function

The Suspend Multipath Reconnection command provides the option of restricting a single channel program to operate only on the path over which the command was received. This command is valid only for devices with the dynamic path selection function.

## Chaining Requirements

None.

## Status

Initial status is zero. Channel end and device end are presented after the command is executed.

## Description

The Suspend Multipath Reconnection command is intended for failure diagnosis in a multipath mode environment. There is no need to restructure a path group that already exists. If the command is accepted, the channel program is restricted to a single path until final status for the command chain is presented and accepted by the channel.

The command has no affect on the state of device reservations and path groups.

# Set Path Group Identifier

0	7 8	31 32	39 40	47 48	63
Command Code	Data Address	Flags	Not Used	Count (Decimal)	
1010 1111 X'AF'	Specifies the main storage location of the first byte of the path group ID	Used at the discretion of the programmer		12	

## Function

The Set Path Group Identifier (ID) command transfers 12 bytes of path group identification information from main storage to the storage director. This command is valid only for devices with the dynamic path selection function.

## Chaining Requirements

The Set Path Group ID command must be the only command in the chain.

## Status

This command is privileged in that it will be executed without testing the status of the addressed device; therefore, initial status is normally zero. Channel end and device end are presented after the command is executed.

## Description

The Set Path Group ID command, with the dynamic path selection (DPS) function, provides greater flexibility in operations on reserved devices. Once a path group for a device has been established, it may be accessed over any path which is a member of the group to which it is reserved. In addition, on 370-XA systems which set the multipath mode bit in the function control byte (byte 0) to a 1, block multiplex reconnections will occur on the first available path which is a member of the group over which the channel program was initiated (regardless of the reservation state of the device).

Path group identifiers must be established in the storage directors to provide the enhanced device pathing function.

The path group identification is used to identify the system control program (SCP) governing a group of channels. Subsequent Device Reserve commands will reserve devices to the *group* of channels having a common ID.

Each SCP must have a unique ID. If the same ID is assigned to more than one SCP, a reserved device will be available to each SCP with the common ID.

When the Set Path Group ID command is received at the storage director, the storage director checks to see if a path group ID had been set for this channel since the last system reset; if not, the path group ID is accepted. If a previous path group ID had been accepted by this channel, the new ID is compared against it. If the comparison is not equal, the command is rejected.

The path group ID for a given channel is common for all the devices attached to the storage director through the same channel.

*Note: Devices are grouped on an individual basis and all devices do not have to be grouped alike. To group all devices alike, the same command must be executed on each device over each path.*

The 12 bytes transferred by this command have the following format:

Byte(s)	Description
0	Function control byte
1-11	Path group ID

## Byte 0

The function control byte (byte 0) has the following format:

Bit	Description
0	0 = Single path mode 1 = Multipath mode
1, 2	00 = Establish group 01 = Disband group 10 = Resign from group 11 = Invalid
3-7	Must be zero

**Path Mode.** Determines whether block multiplexor reconnection is to be attempted in a single path (System/370) mode or multipath (370-XA) mode.

**Establish Group.** The establish group function causes the storage director to compare the ID in bytes 1 through 11 with all other IDs received for the same device over other paths. If any matches are found, a group is formed for the addressed device consisting of all paths with matching IDs.

**Disband Group.** The disband function causes each member of a path group to become a stand alone path to the addressed device. Path groups for the addressed device that did not include the channel issuing the command are not affected.

**Resign from Group.** The resign from group function causes the issuing channel to be removed from the path group for the addressed device. The issuing channel becomes a stand alone channel.

## Bytes 1 through 11

These bytes identify the system control program. These bytes cannot be all 0s. If they are, the parameters are considered invalid and the command is rejected.

If the addressed device is reserved to a path group which is expanded, the device is reserved to the expanded group.

If a device is reserved to a group with multiple paths and the group is contracted through use of the resign from group function, the device remains reserved to the paths remaining in the group.

If a device is reserved to a path group that is disbanded, the device remains reserved to the channel that executed the disband group function.

A system reset causes the path group ID for the channel to be reset. A device that is reserved to the resetting channel will be released if the resetting channel is the only member of a path group. A device that is reserved to more than one channel will remain reserved to the channels that did not execute the reset.

Due to the privileged nature of this command, a system control program should not attempt to expand or contract a path group while it has a CCW chain in progress on the addressed device. Such attempts may cause interrupts to be lost or misdirected, or give other unpredictable results.

# Define Extent

0	7 8	31 32	39 40	47 48	63
Command Code	Data Address	Flags	Not Used	Count (Decimal)	
0110 0011 X'63'	Specifies the main storage location of the first byte of parameters	Used at the discretion of the programmer		16	

## Function

The Define Extent command transfers 16 bytes of parameters from the channel to the storage director. These parameters define limits and block size values for use by subsequent commands in the channel program.

*Note: This command is valid only when the speed matching buffer for the 3375 or 3380 feature is installed.*

## Chaining Requirements

The Define Extent command must not be preceded by another Define Extent, Set File Mask, or Space Count command in the same chain.

## Status

Initial status is normally zero. Channel end and device end are presented after the parameters have been transferred and checked for validity. Invalid parameters cause the command to be terminated with channel end, device end, and unit check status.

## Description

The data extent area, defined by the parameters transferred to the storage director, establishes limits on the device within which subsequent chained commands are permitted to operate. The parameter list also contains an inhibit mask to determine which types of commands are permitted in the chain. The parameters are retained until the end of the command chain. The format of the parameters transferred is:

Byte	Description
0	Mask byte
1	Global attributes
2, 3	Block size (in bytes)
4-7	Reserved (zero)
8-11	CCHH of beginning of extent
12-15	CCHH of end of extent

*Note: An extent is a set of consecutively addressed tracks that can be accessed by a channel program. The limits of the extent are defined by specifying the addresses of the first and last tracks in the extent.*

**Byte 0**

Bits 0 and 1	Function
00	Inhibits Write Home Address and Write RO commands.
01	Inhibits all write commands.
10	Inhibits all format write commands.
11	Permits all write commands.
Bit 2 must be zero or unit check, channel end, and device end are presented in ending status.	
Bits 3 and 4	Function
00	Permits all seek commands.
01	Permits Seek Cylinder and Seek Head commands.
10	Permits Seek Head commands.
11	Inhibits all seek commands and head switching.
Bits 5 and 6 See Note 1.	Function
0	Inhibits Write Special Home Address, Read Special Home Address and seeks to CE and SA tracks.
1	Permits Write Special Home Address, Read Special Home Address and seeks to CE and SA tracks. For 3380s, this bit inhibits retry of data checks in the count, key and data areas of any record other than home address. For 3375s, this bit inhibits retry of data checks in all areas of all records including home address.
Bit 6 must be zero or unit check, channel end, device end and is presented in ending status.	
Bit 7 See Note 2.	Function
0	Not PCI fetch mode.
1	PCI fetch mode. The storage director presents unit check if command retry is used to recover from ECC uncorrectable errors.

**Notes:**

1. *Bit 5 is used for diagnostic purposes only. Use of this bit for any other purpose may yield unpredictable results.*
2. *Bit 7 applies to 3330, 3350, 3375, and 3380 devices only.*

## Byte 1

Bits 0 and 1 must be on (11).

## Bytes 2 and 3

These bytes define the block size. The block size is the maximum number of bytes to be transferred in a single record. On speed matching buffer features, failure to specify the maximum byte count could cause an overrun during write operations.

## Bytes 4 through 7

These bytes must be set to zero.

## Bytes 8 through 11

These bytes contain the cylinder and head number (CCHH) of the beginning of the extent. CCHH is the same format as the cylinder and head numbers of the seek address. These bytes must contain valid addresses or the command is rejected.

## Bytes 12 through 15

These bytes contain the cylinder and head number (CCHH) of the end of the extent. These bytes must contain valid addresses or the command is rejected.

The range of the extent controls subsequent seek and head switching operations for data transfer commands that operate within the domain of a Locate Record command. For other commands, seeking and head switching are controlled by whichever of the following is more restrictive:

- The valid extent range
- The mask byte (byte 0).

When the address (CCHH) in bytes 12 through 15 is greater than the address (CCHH) in bytes 8 through 11, a multitrack extent is indicated. Multitrack head switching is permitted with one restriction: head switching across cylinder boundaries (requiring a new value of CC) is permitted only for data transfer commands executing within the domain of a Locate Record command. Other multitrack operations that attempt to head switch to the next cylinder are terminated. The cylinder value of -3 (X'FFFD'), for DASD Models AA4, A04, B04, AD4/BD4, AJ4/BJ4 but not AE4/BE4 and AK4/BK4, is interpreted as a large positive value and must appear in this field, not in bytes 8 through 11.

An extent defined to include diagnostic cylinder (3380) or 960, and/or 961 (3375) is invalid unless byte 0 bit 5 is set to 1. Otherwise, the Define Extent command will be terminated with unit check (command reject).



# Locate Record

0	7 8	31 32	39 40	47 48	63
Command Code	Data Address	Flags	Not Used	Count (Decimal)	
0100 0111 X'47'	Specifies the main storage location of the first byte of parameters	Used at the discretion of the programmer		16	

## Function

The Locate Record command transfers 16 bytes of parameters from the channel to the storage director. The parameters specify the location and number of records to be processed and the type of operation to be performed on these records.

*Note: This command is only valid when the speed matching buffer for the 3375 or 3380 feature is installed.*

## Chaining Requirements

The Locate Record command must be preceded by a Read IPL or Define Extent command in the same chain.

## Status

Initial status is normally zero. Channel end is presented after the parameters have been transferred and checked for validity. Device end is presented when the storage director is ready to receive the next command. See the following description for conditions causing command termination and status associated with the termination.

## Description

Execution of the Locate Record command establishes a domain within which subsequent data transfer commands, that are chained from the Locate Record command, may operate. The domain is identified by the Locate Record parameters and starts with the first record identified and extends through the processing of the number of records indicated.

*Note: Execution of a Locate Record command initially resets orientation information in the storage director, then establishes the orientation specified by the Locate Record parameters.*

The parameters transferred by this command are summarized below:

**Byte 0** - defines the operations to be performed at the completion of access motion.

**Byte 1** - is used for validating optional fields in the Locate Record command parameters.

**Byte 2** - must be zero.

**Byte 3** - specifies the number of records to be processed by data transfer commands following the Locate Record command.

**Bytes 4 through 7** - specify the seek address.

**Bytes 8 through 12** - specify the search argument to be used by the Locate Record command.

**Byte 13** - contains the sector number.

**Bytes 14 through 15** - contain an optional transfer length factor which may be used to indicate the total number of bytes to be transferred by data transfer commands executing within the domain of the Locate Record command.

## Byte 0

Byte 0 is the operation byte. It specifies the type of operation to be performed at the completion of access motion. Byte 0 consists of two functional parts: bits 0 and 1 are modifier bits, and bits 4 through 7 define the operation code. (Bits 2 and 3 are set to zero.)

**Modifier Bit 0 (Previous)** When this bit is set to 1, the key and data areas of the record that satisfied the search operation will not be processed by the immediately following command. When set to zero, the command following the Locate Record is executed immediately following the successfully compared count field. This bit can only be used with Orient and Read Data operation codes and it cannot be set to 1 if the search modifier (bit 1) is set to 1.

**Modifier Bit 1 (Search Modifier)** When this bit is set to zero, search operations operate on count fields; when set to 1, search operations operate on the home address area. (See Bytes 8 through 12.) This bit can only be used with Orient, Format Write, and Read Data operation codes and it cannot be set to 1 when bit 0 is set to 1.

**Operation Code Bits (4 through 7)** These bits define the following operations:

Bits 4-7	Description
0000	Orient
0001	Write Data
0011	Format Write
0110	Read Data
1011	Write Track

Any other combination of bit settings is invalid and causes the command to terminate with device end, channel end, and unit check status.

*Orient (0000):* This operation code orients the device according to the seek, search, and sector values in parameter bytes 4 through 13. Bytes 3, 14, and 15 must be zero. When the device is at the proper sector, the search function described in bytes 8 through 12 is executed.

*Note:* *The search function is normally performed during execution of the CCW chained from the Locate Record command. If the CCW following the Locate Record command is a control type command (except Space Count), a sense type command, Read Sector command, or a Read IPL command, the search function is not performed.*

If the search operation is not successful, unit check will be included in the ending status for a CCW that follows a Locate Record command.

Device end status is presented when the track is positioned at the sector value specified in byte 13.

*Write Data (0001):* This operation code prepares the storage director to write the number of records specified in byte 3, starting with the record specified in bytes 8 through 12.

The device is positioned according to the seek, search, and sector values specified in bytes 4 through 13. When the device is at the proper sector, the search function described in bytes 8 through 12 is executed.

*Note:* *The search function may be performed during execution of a read CCW that follows the Locate Record command.*

If the search is not successful, unit check will be included in the ending status for a CCW that follows a Locate Record command.

The block size value from parameter bytes 2 and 3 of the previously executed Define Extent command, or the transfer length factor specified in bytes 14 and 15 of the Locate Record command, must be equal to the record length of the records to be updated. The record length must be equal to the data length of the record to be updated or to the sum of the key and data length, depending on whether the following data transfer command specifies Write Data or Write Key and Data. If the record length differs, the channel program is terminated with unit check and intent violation is indicated in the sense information.

*Note:* *The unit check will be included in the ending status for a write CCW that follows the Locate Record command.*

A Locate Record command specifying a Write Data operation code must be followed by the number (count) of update write commands specified in byte 3. When the value in byte 3 is 1, a Write Data, Write Key and Data, Write Update Data, or Write Update Key and Data command must be chained from the Locate Record command. If the value specified in byte 3 is greater than 1 (n), the Locate Record command must be followed by either (n) Write Update Data commands or (n) Write Update Key and Data commands. If the subsequent CCWs do not conform to this requirement, the command is rejected with unit check status and command reject is indicated in the sense information.

*Format Write (0011):* This operation code prepares the storage director to write the number of records specified in byte 3.

The device is positioned according to the seek, search, and sector values specified in bytes 4 through 13. When the device is at the proper sector, the search function described in bytes 8 through 12 is executed.

*Note:* The search function may be performed during execution of a write CCW that follows the Locate Record command.

If the search is not successful, unit check will be included in the ending status of a CCW that follows a Locate Record command.

A Locate Record command specifying a Format Write operation code must be followed by the number (count) of format write commands specified in byte 3. In addition, the Format Write operation code has the following chaining requirements:

- If byte 0 bit 1 = 1; Locate Record must be followed by a Write HA or Write R0.
- If byte 0 bit 1 = 0; Locate Record must be followed by a Write CKD.
- A Write Home Address command must be followed by a Write R0 command.
- A Write R0 command must be followed by a Write CKD command.
- A Write CKD command must be followed by another Write CKD command or a Write CKD Next Track command.
- A Write CKD Next Track command must be followed by another Write CKD Next Track, or a Write CKD command.

*Read Data (0110):* This operation code prepares the storage director to read the number of records specified in byte 3.

*Note:* The search function may be performed during execution of a read CCW that follows the Locate Record command.

If the search is not successful, unit check will be included in the ending status of a CCW that follows a Locate Record command.

A Locate Record command specifying a Read Data operation code must be followed by the number of read commands required to transfer the number of records indicated in byte 3 before any other CCW can be executed.

Read Multiple CKD, Read Sector, Read Special Home Address, and Read IPL commands are not permitted; any other sequence of read type commands is valid.

*Write Track (1011):* This operation code prepares the storage director to orient to home address, search ID equal on record zero, write data in the data area of record zero, and format the remainder of the track. The number of records indicated in byte 3 includes the update of R0.

The search modifier (byte 0, bit 1) must be zero for this operation. Byte 13, the sector number, is ignored; the storage director executes an internal set sector zero. The block size value specified in parameter bytes 2 and 3 of the previously executed Define Extent command, or the transfer length factor specified in bytes 14 and 15 of the Locate Record command applies to the format write operations which follow the update of record zero. The storage director assumes a value of 8 for the R0 data length. If the R0 data area is not eight bytes long, the operation is ended with status that includes Unit Check (Intent Violation).

The search function is executed once. If bytes 8 through 12 do not compare equal to the ID of R0, ending status for a write CCW that follows a Locate Record command will include unit check and the sense information will indicate no record found. A Locate Record command must be followed by a Write Data CCW and "n-1" Format Write CCWs, where "n" is the value of the count parameter in byte 3. The last Format Write CCW may be an Erase CCW.

*Note: This command can be used to restore full tracks. Such restore operations must search on R0 to determine if an alternate track exists, then update write the data area of R0 and format the remainder of the track.*

*The following command sequence permits the restoration of an empty track on a single revolution:*

*Locate Record  
Write Track (byte 3 = 2)  
Write Data (count = 8)  
Erase (count = 8)*

*The CCW count for the Erase command should be limited to 8 to avoid unneeded data transfer overhead. Erase, when specified, should be the last CCW in the domain of a Locate Record - Write Track operation. No other write CCW can be chained from an Erase command.*

## Byte 1

Byte 1 is an auxiliary byte. It is used to validate optional fields in the Locate Record parameters. When bit 0 is on, it indicates that bytes 14 and 15 contain the transfer length factor. The transfer length factor must not be zero when bit 0 is on and must be zero when bit 0 is off. Bits 1 through 7 must be zero.

## Byte 2

Byte 2 must be set to zero.

### Byte 3

Byte 3 is the record count. It specifies the number of records to be processed by the data transfer commands following the Locate Record command. Unless the operation code specifies Orient, this byte must not be zero.

*Note: On write operations, a failure to write all of the records specified could result in a data problem. If the number of Write CCWs that follow a Locate Record command is less than the value in the count parameter, the channel program may end before all the data that was transferred to the 3880 has been written to the device. If subsequent conditions prevent the control unit from successfully writing this data to the device, no error indication is sent to the host system.*

### Bytes 4 through 7

Bytes 4 through 7 specify a seek address (CCHH). The seek address must be within the extent defined by the previously executed Define Extent command.

### Bytes 8 through 12

Bytes 8 through 12 specify a value (CCHHR) used as a search argument. They are used for orientation before reading and writing. These bytes are compared with the CCHHR bytes of the count area or CCHH bytes of the home address area on the track. All bytes must compare equal before data is transferred to or from the disk storage.

### Byte 13

Byte 13 contains a sector number. The storage director executes an internal set sector using the value in this byte either as is, or adjusted, before establishing track orientation.

### Bytes 14 and 15

Bytes 14 and 15 contain an optional transfer length factor. When byte 1, bit 0 is set to 1, the storage director uses the product of the value in byte 3 (record count) and the value in bytes 14 and 15 to determine the number of bytes transferred by data transfer commands executing within the domain of this Locate Record command.

The transfer length factor replaces the block size value retained from the Define Extent parameters or a transfer length factor value retained from a previous Locate Record parameter. If a Locate Record command does not specify a transfer length factor, the storage director uses the most recent retained value for any needed total data transfer length calculations.

The transfer length factor should only be used by programs dealing with variable length records. For fixed length records, the block size value from the Define Extent command should be the only length value required.

Channel programs should follow a convention of using the transfer length factor in every Locate Record CCW, or not using it at all.

## Performance Factors

Performance can be significantly affected by the way that Locate Record commands are used in the channel program. For example, two channel programs might read or write two consecutively addressed records on a track. The first channel program consists of a single Locate Record command followed by two read or write commands. The other channel program consists of two Locate Record commands, each of which is followed by a single read or write command. While both channel programs provide the same function, the second channel program will always take longer to execute. This is because the storage director, after transferring the first record, must transfer and validate another Locate Record parameter list and position the device to begin transfer of the second record. The transfer of the second record may be delayed up to a full revolution of the disk.

For write operations on a slow channel, the maximum number of records that can be written is determined by: a) the number of data transfer CCWs chained to the Locate Record command, or b) the record count in byte 3 of the Locate Record command.

However, if command chaining ends before the specified number of records have been processed, no unit check (intent violation) can be reported since ending status for the CCW chain has already been cleared. Therefore, the number of records processed within a Locate Record domain, is the smaller of a) or b).

Channel programs which do not include sufficient data transfer CCWs to exhaust the record count specified in the Locate Record command will not receive any indication that this happened.

# Search Home Address Equal

Command Code	Data Address	Flags	Not Used	Count (Decimal)
0011 1001 X'39' <b>Multitrack:</b> 1011 1001 X'B9'	Specifies the main storage location of a cylinder number (CC) and a head number (HH)	Used at the discretion of the programmer		4

## Function

The Search Home Address Equal command causes the storage director to compare the four bytes of home address data from main storage with four bytes of home address data from the drive.

## Chaining Requirements

If the 3380 AJ4/AK4 Attachment (Feature 3005) is installed, this command must be preceded by a Seek, Seek Cylinder, Read IPL, Locate Record, or Recalibrate command.

## Status

Initial status is normally zero. Channel end and device end are presented if the comparison is not equal. Channel end, device end, and status modifier are presented when the comparison is equal.

## Description

The execution of a Search Home Address Equal command causes the storage director to search for index. When index is detected, the storage director compares the cylinder and head numbers from main storage with the cylinder and head numbers from the track home address.

If the multitrack bit is off, the search is confined to one track. The search continues (as long as the channel repeats the command) until the condition is satisfied or index is sensed again. When index is detected for the second time, channel end, device end, and unit check status are presented to the channel.

If the multitrack bit is on and the file mask permits, the head number automatically increments when index is detected. The search then continues (as long as the channel repeats the command) until the search condition is satisfied or until the head number advances beyond the end of the cylinder (head 11 for 3340, 3344, and 3375; head 18 for 3330; head 29 for 3350; and head 14 for 3380). Channel end, device end, and unit check status are presented at the end of the cylinder.



If the CCW count is greater than four bytes, only the first four bytes are used. Channel end and device end status are presented to terminate the command. Status modifier is also presented if the comparison was equal.

If the CCW count is less than four bytes, comparison of main storage and track data continues until the CCW count reaches zero. Channel end and device end status are presented after the home address and correction code bytes have been read and checked. Status modifier is also presented if the comparison was equal.

The validity of the data is verified by the correction code bytes following the home address area. If the data is not valid, channel end, device end, and unit check status (data check) are presented.

# Search Identifier Equal

Command Code	Data Address	Flags	Not Used	Count (Decimal)
0011 0001 X'31' <b>Multitrack:</b> 1011 0001 X'B1'	Specifies the main storage location of a five-byte record identifier (CC HH R)	Used at the discretion of the programmer		5

## Function

The Search Identifier (ID) Equal command causes the storage director to compare the five bytes (CC HH R) from main storage with the five-byte count area ID from the drive.

## Chaining Requirements

If the 3380 AJ4/AK4 Attachment (Feature 3005) is installed, this command must be preceded by a Seek, Seek Cylinder, Read IPL, Locate Record, or Recalibrate command.

## Status

Initial status is normally zero. Channel end and device end are presented if the comparison is not equal. Channel end, device end, and status modifier are presented when the comparison is equal.

## Description

The execution of the Search ID Equal command causes the ID from main storage to be compared with the count area ID of the next record read on the track (including R0).

If the multitrack bit is off, the search is confined to one track. The search continues (as long as the channel repeats the command) until the condition is satisfied or index is sensed again. When index is detected, channel end, device end, and unit check status are presented to the channel.

If the multitrack bit is on and the file mask permits, the head number automatically increments when index is detected. The search then continues (as long as the channel repeats the command) until the search condition is satisfied or until the head number advances beyond the end of the cylinder (head 11 for 3340, 3344, and 3375; head 18 for 3330; head 29 for 3350; and head 14 for 3380). Channel end, device end, and unit check status are presented at the end of the cylinder.

If the CCW count is greater than five bytes, only the first five bytes are used. Channel end and device end status are presented to terminate the command. Status modifier is also presented if the comparison was equal.

If the CCW count is less than five bytes, comparison of main storage and track data continues until the CCW count reaches zero. Channel end and device end status are presented after the count area correction code bytes have been read and checked. Status modifier is also presented if the comparison was equal.

The validity of the data is verified by the correction code bytes following the count area. If the data is not valid, channel end, device end, and unit check status (data check) are presented.

# Search Identifier High

Command Code	Data Address	Flags	Not Used	Count (Decimal)
0101 0001 X'51' Multitrack: 1101 0001 X'D1'	Specifies the main storage location of a five-byte record identifier (CC HH R)	Used at the discretion of the programmer		5

## Function

The Search Identifier (ID) High command causes the storage director to compare the five bytes (CC HH R) from main storage with the five-byte count area ID from the drive.

## Chaining Requirements

If the 3380 AJ4/AK4 Attachment (Feature 3005) is installed, this command must be preceded by a Seek, Seek Cylinder, Read IPL, Locate Record, or Recalibrate command.

## Status

Initial status is normally zero. Channel end, device end, and status modifier are presented if the ID on the drive is higher than the ID from main storage. Channel end and device end are presented when the ID from the drive is not higher.

## Description

The execution of the Search ID High command causes the ID from main storage to be compared with the count area ID of the next record read on the track (including R0).

If the multitrack bit is off, the search is confined to one track. The search continues (as long as the channel repeats the command) until the condition is satisfied or index is sensed again. When index is detected, channel end, device end, and unit check status are presented to the channel.

If the multitrack bit is on and the file mask permits, the head number automatically increments when index is detected. The search then continues (as long as the channel repeats the command) until the search condition is satisfied or until the head number advances beyond the end of the cylinder (head 11 for 3340, 3344, and 3375; head 18 for 3330; head 29 for 3350; and head 14 for 3380). Channel end, device end, and unit check status are presented at the end of the cylinder.

If the CCW count is greater than five bytes, only the first five bytes are used. Channel end and device end status are presented to terminate the command. Status modifier is also presented if the drive ID was higher than the ID from main storage.

If the CCW count is less than five bytes, comparison of main storage and track data continues until the CCW count reaches zero. Channel end and device end status are presented after the count area and correction code bytes have been read and checked. Status modifier is also presented if the drive ID is higher than the ID from main storage.

The validity of the data is verified by the correction code bytes following the count area. If the data is not valid, channel end, device end, and unit check status (data check) are presented.

# Search Identifier Equal or High

0	7 8	31 32	39 40	47 48	63
Command Code	Data Address	Flags	Not Used	Count (Decimal)	
0111 0001 X'71' <b>Multitrack:</b> 1111 0001 X'F1'	Specifies the main storage location of a five-byte record identifier (CC HH R)	Used at the discretion of the programmer		5	

## Function

The Search Identifier (ID) Equal or High command causes the storage director to compare the five bytes (CC HH R) from main storage with the five-byte count ID area from the drive.

## Chaining Requirements

If the 3380 AJ4/AK4 Attachment (Feature 3005) is installed, this command must be preceded by a Seek, Seek Cylinder, Read IPL, Locate Record, or Recalibrate command.

## Status

Initial status is normally zero. Channel end, device end, and status modifier are presented if the ID in the drive is equal to or higher than the ID from main storage. Channel end and device end are presented if the ID from the drive is not equal to or higher than the ID from the drive.

## Description

The execution of the Search ID Equal or High command causes the ID from main storage to be compared with the count area ID of the next record read on the track (including R0).

If the multitrack bit is off, the search is confined to one track. The search continues (as long as the channel repeats the command) until the condition is satisfied or index is sensed again. When index is detected, channel end, device end, and unit check status are presented to the channel.

If the multitrack bit is on and the file mask permits, the head number automatically increments when index is detected. The search then continues (as long as the channel repeats the command) until the search condition is satisfied or until the head number advances beyond the end of the cylinder (head 11 for 3340, 3344, and 3375; head 18 for 3330; head 29 for 3350; and head 14 for 3380). Channel end, device end, and unit check status are presented at the end of the cylinder.

If the CCW count is greater than five bytes, only the first five bytes are used. Channel end and device end status are presented to terminate the command. Status modifier is also presented if the comparison was equal or high.

If the CCW count is less than five bytes, comparison of main storage and track data continues until the CCW count reaches zero. Channel end and device end status are presented after the count area and correction code bytes have been read and checked. Status modifier is also presented if the comparison was equal or high.

The validity of the data is verified by the correction code bytes following the count area. If the data is not valid, channel end, device end, and unit check status (data check) are presented.

# Search Key Equal

0	7 8	31 32	39 40	47 48	63
Command Code	Data Address	Flags	Not Used	Count (Decimal)	
0110 1001 X'20' <b>Multitrack:</b> 1010 1001 X'A9'	Specifies the main storage location of a five-byte record identifier (CC HH R)	Used at the discretion of the programmer		5	

## Function

The Search Key Equal command causes the storage director to compare the key data from main storage with the key area read from the track.

## Chaining Requirements

If the 3380 AJ4/AK4 Attachment (Feature 3005) is installed, this command must be preceded by a Seek, Seek Cylinder, Read IPL, Locate Record, or Recalibrate command.

## Status

Initial status is normally zero. Channel end, device end, and status modifier are presented if the key from main storage compares equally with the key from the track. Channel end and device end are presented if the comparison is not equal.

## Description

The execution of the Search Key Equal command causes the key data from main storage to be compared with the next key area read on the track (including R0).

*Note: When this command is chained from a search ID or a Read Count command, the key compared is in the same record as the ID or count area. The Search Key Equal command bypasses R0 unless it is chained from a command that searched the ID of R0.*

If the multitrack bit is off, the search is confined to one track. The search continues (as long as the channel repeats the command) until the condition is satisfied or index is sensed again. When index is detected, channel end, device end, and unit check status are presented to the channel.



If the multitrack bit is on and the file mask permits, the head number automatically increments when index is detected. The search then continues (as long as the channel repeats the command) until the search condition is satisfied or until the head number advances beyond the end of the cylinder (head 11 for 3340, 3344, and 3375; head 18 for 3330; head 29 for 3350; and head 14 for 3380). Channel end, device end, and unit check status are presented at the end of the cylinder.

If the CCW count is greater than the key length (KL), the search operation is completed when the key area is read. Channel end and device end status are presented to terminate the command. Status modifier is also presented if the comparison was equal.

The validity of the data is verified by the correction code bytes following the key area. If the data is not valid, channel end, device end, and unit check status (data check) are presented.

# Search Key High

0	7 8	31 32	39 40	47 48	63
Command Code	Data Address	Flags	Not Used	Count (Decimal)	
0100 1001 X'49' <b>Multitrack:</b> 1100 1001 X'C9'	Specifies the main storage location to which the key is compared	Used at the discretion of the programmer			Equal to the length of the argument

## Function

The Search Key High command causes the storage director to compare the key data from main storage with the key area read from the track.

## Chaining Requirements

If the 3380 AJ4/AK4 Attachment (Feature 3005) is installed, this command must be preceded by a Seek, Seek Cylinder, Read IPL, Locate Record, or Recalibrate command.

## Status

Initial status is normally zero. Channel end, device end, and status modifier are presented if the key from the drive is higher than the key from main storage. Channel end and device end are presented if the key from drive is not higher.

## Description

The execution of the Search Key High command causes the key data from main storage to be compared with the next key area read on the track (including R0).

*Note: When this command is chained from a search ID or Read Count command, the key compared is in the same record as the ID or count area. The Search Key High command bypasses R0 unless it is chained from a command that searched the ID or R0.*

If the multitrack bit is off, the search is confined to one track. The search continues (as long as the channel repeats the command) until the condition is satisfied or index is sensed again. When index is detected, channel end, device end, and unit check status are presented to the channel.

If the multitrack bit is on and the file mask permits, the head number automatically increments when index is detected. The search then continues (as long as the channel repeats the command) until the search condition is satisfied or until the head number advances beyond the end of the cylinder (head 11 for 3340, 3344, and 3375; head 18 for 3330; head 29 for 3350; and head 14 for 3380). Channel end, device end, and unit check status are presented at the end of the cylinder.

If the CCW count is greater than the key length (KL), the search operation is completed when the key area is read. Channel end and device end status are presented to terminate the command. Status modifier is also presented if the comparison was high.

If the CCW count is less than the KL, comparison of main storage and track data continues until the CCW count reaches zero. Channel end and device end are presented after the key area correction code bytes have been read and checked. Status modifier is also presented if the comparison was high.

The validity of the data is verified by the correction code bytes following the key area. If the data is not valid, channel end, device end, and unit check status (data check) are presented.

# Search Key Equal or High

0	7 8	31 32	39 40	47 48	63
Command Code	Data Address	Flags	Not Used	Count (Decimal)	
0110 1001 X'69' <b>Multitrack:</b> 1110 1001 X'E9'	Specifies the main storage location to which the key is compared	Used at the discretion of the programmer		Equal to the length of the argument	

## Function

The Search Key Equal or High command causes the storage director to compare the key data from main storage with the key area read from the track.

## Chaining Requirements

If the 3380 AJ4/AK4 Attachment (Feature 3005) is installed, this command must be preceded by a Seek, Seek Cylinder, Read IPL, Locate Record, or Recalibrate command.

## Status

Initial status is normally zero. Channel end, device end, and status modifier are presented if the key from the drive is equal to or higher than the key from the main storage. Channel end and device end are presented if the key from the drive is lower than the key from main storage.

## Description

The execution of the Search Key Equal or High command causes the key data from main storage to be compared with the next key area read on the track (excluding R0).

*Note: When this command is chained from a search ID or Read Count command, the key compared is in the same record as the ID or count area. The Search Key Equal or High command bypasses R0 unless it is chained from a command that searched the ID of R0.*

If the multitrack bit is off, the search is confined to one track. The search continues (as long as the channel repeats the command) until the condition is satisfied or index is sensed again. When index is detected, channel end, device end, and unit check status are presented to the channel.

If the multitrack bit is on and the file mask permits, the head number automatically increments when index is detected. The search then continues (as long as the channel repeats the command) until the search condition is satisfied or until the head number advances beyond the end of the cylinder (head 11 for 3340, 3344, and 3375; head 18 for 3330; head 29 for 3350; and head 14 for 3380). Channel end, device end, and unit check status are presented at the end of the cylinder.

If the CCW count is greater than the key length (KL), the search operation is completed when the key area is read. Channel end and device end status are presented to terminate the command. Status modifier is also presented if the comparison was equal or high.

If the CCW count is less than the KL, comparison of main storage and track data continues until the CCW count reaches zero. Channel end and device end status are presented after the key area correction code bytes have been read and checked. Status modifier is also presented if the comparison was equal or high.

The validity of the data is verified by the correction code bytes following the key area. If the data is not valid, channel end, device end, and unit check status (data check) are presented.

# Read Home Address

0	7 8	31 32	39 40	47 48	63
Command Code	Data Address	Flags	Not Used	Count (Decimal)	
0001 1010 X'1A' <b>Multitrack:</b> 1001 1010 X'9A'	Specifies the main storage location where the home address is to be started	Used at the discretion of the programmer		5	

## Function

The Read Home Address command transfers the home address area of a track to main storage.

## Chaining Requirements

If the 3380 AJ4/AK4 Attachment (Feature 3005) is installed, this command must be preceded by a Seek, Seek Cylinder, Read IPL, Locate Record, or Recalibrate command.

## Status

Initial status is normally zero. Channel end and device end are presented after reading the home address correction code bytes.

## Description

The Read Home Address command transfers the flag, cylinder, and head bytes of the home address area to the channel. The validity of the data read is verified by the correction code bytes following the home address area.

If the multitrack bit is on and the file mask permits, the flag, cylinder, and head bytes of the home address area are transferred to the channel.

If a data overrun or data check is detected on a 3330, 3350, 3375, or 3380 during the execution of this command, the storage director attempts recovery with command retry. If command retry is unsuccessful, channel end, device end, and unit check status are presented to the channel.

# Read Special Home Address

0	7 8	31 32	39 40	47 48	63
Command Code	Data Address	Flags	Not Used	Count (Decimal)	
0000 1010 X'0A'	Specifies the main storage location where the first byte of home address is to be stored	Used at the discretion of the programmer		27 - 3375 28 - 3380	

## Function

The Read Special Home Address command transfers the home address area on a 3375 or 3380 track to main storage. This command is valid for 3375s, and 3380s only.

## Chaining Requirements

The Read Special Home Address command must be preceded by a Define Extent or Set File Mask command, allowing execution of Diagnostic commands.

If the 3380 AJ4/AK4 Attachment (Feature 3005) is installed, this command must be preceded by a Seek, Seek Cylinder, Read IPL, Locate Record, or Recalibrate command.

## Status

Initial status is normally zero. Channel end and device end are presented after reading the home address correction code bytes.

## Description

The Read Special Home Address command transfers the skip control bytes, segment number, physical address bytes, flag, and identifier bytes (CCHH) of the home address area to the channel. The validity of the data read is verified by the correction code bytes following the home address area.

If a data overrun or data check is detected during execution of this command, the storage director attempts recovery through use of command retry. If command retry is unsuccessful, channel end, device end, and unit check are presented to the channel.

## Chapter 5. Standard and Special Features

This section of the manual describes the features available with the 3880 and its attached disk storage, and gives examples of how to use the features.

### Multitrack

The multitrack feature is a standard feature that applies to all disk storage devices except the 3370. It is not required on devices that use fixed block formats.

On all search and most read commands, a storage director can automatically select the next sequentially numbered head on the disk drive under control of bit 0 of the command code. If bit 0 is a 1 and data transfer of the command has not been initiated, the next sequentially numbered head is selected at index. Thus, the need for Seek Head commands in a chain of read or search commands is eliminated.

Discretion must be used when using the multitrack bit. For example, assume that during a multitrack search operation the desired record is on the first track searched and the search begins after that record is passed. The head number, therefore, is advanced to the next track without comparing the key or ID of the desired record. Also, should a Set Sector command with a sector value of zero precede a multitrack command, head switching could occur before the desired record is reached. To avoid these conditions, a single-track Read Home Address or Read R0 command should be placed before the search command, thus ensuring that the search begins at R0 or R1 of the track. (See Figure 5-1 on page 5-2 for an example of a multitrack operation.)

Multitrack operations are not used on Read IPL, Read Sector, or Read Multiple CKD commands.



## Cylinder 02

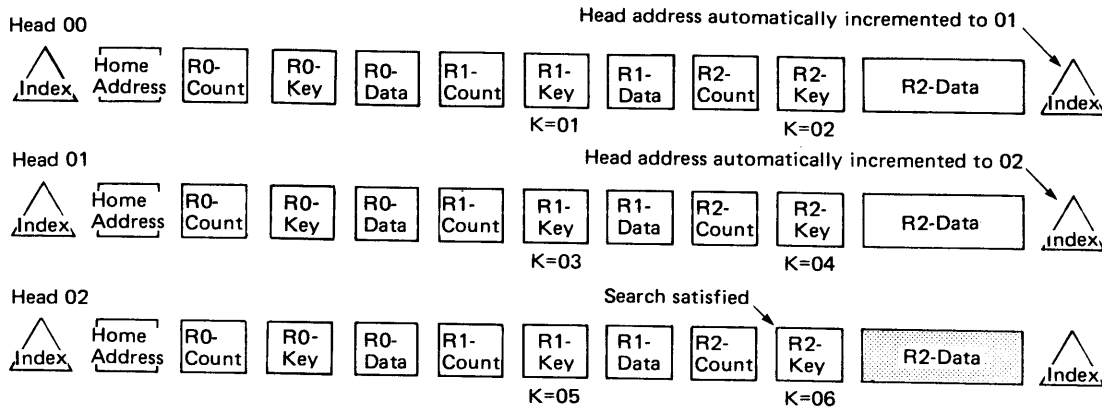

The disk is organized by keys, and the physical address of the record is unknown.

### Channel Program:

```

Seek (cylinder 02, head 00)
Set File Mask (allow write and seek commands)
Set Sector (sector number = 00)
Read Home Address (make sure all records are read)
Search Key Equal (multitrack bit on, argument = 06)
TIC *-8
Write Data (updates shaded area)
  
```

Figure 5-1. Multitrack

# Record Overflow

The record overflow feature is a standard feature that applies to 3330, 3333, 3340, 3344, and 3350 disk storage devices; it is not supported by 3375 or 3380. Record overflow provides a means of processing logical records that exceed the capacity of a track. When using overflow records, the cylinder boundary limits the size of the record.

Each part of an overflow record written on (or read from) one track is called a record segment. Each segment contains a count, key (optional), and data field.

## Formatting Overflow Records

The Write Special CKD command is used to format all segments of an overflow record except the last segment. The key and data lengths specified in the KL and DL bytes of the count field of the command pertain only to that segment, not the complete overflow record. Except for the first overflow segment, the record number in the count fields of all the subsequent segments must be 1. Since only the key field of the first segment has significance, overflow records are usually formatted without key fields (KL=0). The last segment is formatted with a normal Write CKD command as shown in Figure 5-2 on page 5-4.

When a Write Special CKD command is executed, a 1 is written in the flag byte bit position 4 of the record segment being written. This bit, which identifies the record as an overflow segment, indicates to the following record processing commands that the logical record continues in the following track.

No internally generated head switching is associated with formatting overflow records; all head seeking must be done by the formatting program, as shown in Figure 5-2.

Except for the first, all record segments must be written immediately following R0, and all segments except the last must be the last physical record on their tracks.

## Cylinder 02

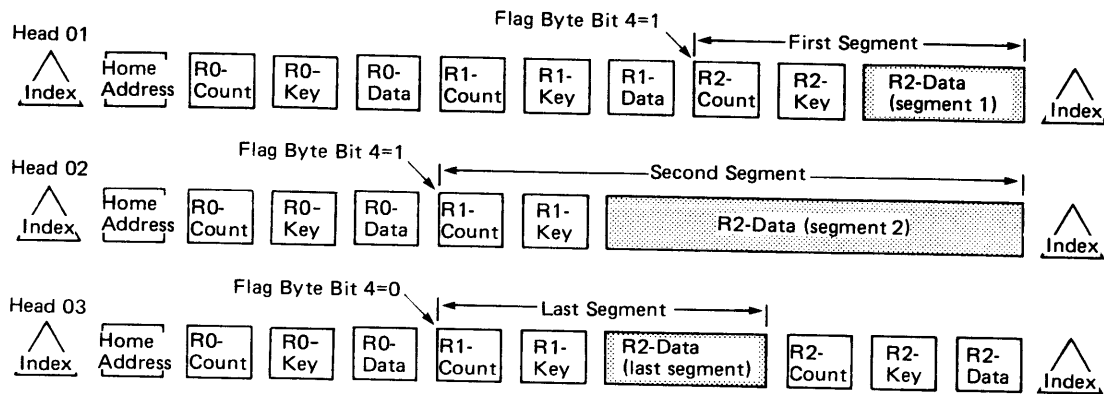

Typical channel programs for formatting, updating, and reading overflow records.

### Formatting:

Seek (cylinder 02, head 01)  
 Set File Mask  
 Set Sector  
 Search ID R1 (track 1)  
 TIC \*-8  
 Write Special CKD (segment 1)  
 Seek Head (next track)  
 Search ID R0 (track 2)  
 TIC \*-8  
 Write Special CKD (segment 2)  
 Seek Head (next track)  
 Search ID R0 (track 3)  
 TIC \*-8  
 Write CKD (last segment)

### Updating:

Seek (cylinder 02, head 01)  
 Set File Mask  
 Set Sector  
 Search ID R2 (segment 1)  
 TIC \*-8  
 Write Data

### Reading:

Seek (cylinder 02, head 01)  
 Set File Mask  
 Set Sector  
 Search ID R2 (segment 1)  
 TIC \*-8  
 Read Data

Figure 5-2. Overflow Record

## Processing Overflow Records

The following commands may be used to read or update previously formatted overflow records:

- Read Count, Key, and Data
- Read Key and Data
- Read Data
- Write Key and Data
- Write Data.

When any of the above commands are used to process an overflow record, the operation does not stop at the end of a record segment when the segment is flagged with bit 4 (on) in the flag byte. Instead, the head address is incremented by one at index and the operation continues in the data field of record 1 on the next track. If this record segment is also flagged with bit 4 (on) in the flag byte, the operation continues on the next track. When a segment is found that is not flagged, the operation finishes at the end of the data field. The net effect of this procedure is that the data fields of all the record segments appear as a single logical data field.

If a data overrun or data check occurs during the first segment, the storage director attempts recovery through use of command retry. If a data overrun occurs during an operation involving the second (or subsequent) segments, unit check is signaled immediately during a read operation, or at the end of the associated segment during write operations.

If a data check or bus out parity error occurs, unit check is signaled at the end of the associated area.

*Note: If a write operation was in progress, unit check is signaled at the end of the record segment.*

If the CCW count is less than the number of bytes in the logical record, the operation continues to the end of the logical record before presenting ending status.

Spacing over overflow records does not occur automatically. The channel program must be written so that the entire logical record is spaced over, not just the first segment. For example, in the sequence:

Set Sector  
Search ID (first segment)  
TIC \*-8  
Read CKD (multitrack)

the Read CKD command does *not* read the next logical record on the cylinder. It begins reading the overflow record at the count field of the second segment.

The sequence:

Set Sector  
Search ID (first segment)  
TIC \*-8  
Read Key and Data (skip flag on)  
Read CKD (multitrack)

reads the count, key, and data fields of the next logical record.

Multitrack operations should not be confused with overflow record operations. Head switching, when processing overflow records, occurs regardless of whether the multitrack bit is on or off.

Head switching does not occur:

- In violation of the file mask
- Past the end of the cylinder
- To a defective track
- To an alternate track.

All segments of an overflow record, except the first, must be written immediately following record zero; all segments, except the last, must be the last physical record on their respective tracks.

## End of File

The end-of-file feature is a standard feature that applies to all disk storage devices except the 3370. It is not required on devices that use fixed block formats.

An end-of-file record, used to define the end of a logical group of records, is written by executing a Write CKD, Write Special CKD, or Write R0 command with the data length (DL) bytes in the count area set to zero. Execution of one of these commands with a data length of zero causes the storage director to write a data area consisting of one byte (20 for 3380; 32 for 3375) of zeros followed by the error correction code bytes, as shown in Figure 5-3 on page 5-8.

The key length (KL) portion of the count area can be either zero or nonzero. If KL equals zero, the end-of-file record contains only the contents of the count and data areas. If the key length is not zero, the key area is written as specified by the KL byte.

Detection of a zero data length causes unit exception status to be generated. No data from the data area is transferred to the channel. A Read R0, Read CKD, or Read Key and Data (KD) command transfers the key area (if any) to the channel.

The unit exception is generated during execution of Read IPL, Read R0, Read CKD, Read KD, Read Data, Write KD, and Write Data commands.

*Note: When an end-of-file (EOF) mark is written, the DL in the count area must be zero. The storage director, however, adds a one-byte data area (20 bytes for 3380; 32 for 3375) when writing the EOF mark. Programmers working with track balance routines must allow for this byte(s) by subtracting one byte (20 for 3380; 32 for 3375) from the track balance remaining. The overhead allowance (for example, 135 for 3330) should, therefore, be increased by one (20 for 3380; 32 for 3375) for each EOF written.*

## Cylinder 02

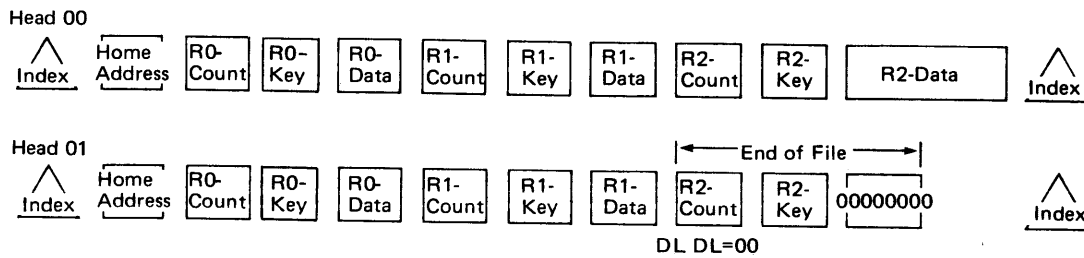

### Channel Program:

Seek (cylinder 02, head 00)	Seek (cylinder 02, head 01)
Set File Mask (allow seek and write)	Search ID R0
Set Sector	TIC *.8
Search ID R0	Write CKD R1
TIC *.8	Write CKD R2 (data length = 00)
Write CKD R1	
Write CKD R2	

Figure 5-3. End of File

# Rotational Position Sensing

Rotational position sensing (RPS) is a standard feature (special on 3340) that reduces the time required for the channel to search for a record. This feature lets a search command be started just before the required record comes under the read/write head.

Rotational position sensing is accomplished by dividing the storage disks into sectors. Each track in the cylinder is divided into equally spaced sectors and each track record has a sector location and a record address. When chained to a read, write, or search CCW, the Read Sector command provides the sector location required to access the record that was processed by the previous command. A later Set Sector command sends the sector value back to the storage director and causes it to reconnect to the channel just ahead of that record location. This type of operation is particularly useful in write verification (see Figure 9) and sequential disk processing operations.

The sector location of a record is determined by the length of all records that are ahead of it and its sequential position on the track. The sector value for record  $n$  ( $n \neq 0$ ) can be calculated with the following formulas. (If  $n=0, S(n)=0$ .)

The following formulas include some tolerance. The value will connect ahead of the target record. However, the target record may not be in the calculated sector; a search command must be used to establish orientation.

## 3330 Series

$$S(n) = \frac{1}{105} \left[ 237 + \sum_{i=1}^{n-1} (KL_i + DL_i + C) \right]$$

Where:

$C=135$  if  $KL_i = 0$

$C=191$  if  $KL_i \neq 0$

## 3340 Series Drives

$$S(n) = \frac{1}{140} \left[ 353 + \sum_{i=1}^{n-1} (KL_i + DL_i + C) \right]$$

Where:

$C=167$  if  $KL_i = 0$

$C=242$  if  $KL_i \neq 0$



### 3350 Series Drives

$$S(n) = \frac{1}{156} \left[ 389 + \sum_{i=1}^{n-1} (KL_i + DL_i + C) \right]$$

Where:

C = 187 if  $KL_i = 0$

C = 267 if  $KL_i \neq 0$

### 3375 Series

$$S(n) = \frac{1}{192} \left[ 832 + \sum_{i=1}^{n-1} (KL_i + DL_i + C) \right]$$

Where:

$KL_i$  = key length rounded up to a multiple of 32

$DL_i$  = data length rounded up to a multiple of 32

C = 384 if  $KL_i = 0$

C = 544 if  $KL_i \neq 0$

### 3380 Series

$$S(n) = \frac{1}{224} \left[ 1248 + \sum_{i=1}^{n-1} (KL_i + DL_i + C) \right]$$

Where:

$KL_i$  = key length plus 12 rounded up to a multiple of 32

$DL_i$  = data length plus 12 rounded up to a multiple of 32

C = 480 if  $KL_i = 0$

C = 704 if  $KL_i \neq 0$

The following example shows some of the advantages of using rotational position sensing to find and retrieve records.

### 3340 without RPS

<b>Command</b>	<b>Channel and Storage Director Status</b>
Seek	Available when the storage director accepts the seek address.
Search ID Equal	Busy (average of 1/2 revolution or 10.2 ms on the 3340).
TIC *-8	
Read Data	Busy.

### 3330, 3340/3344, 3350, 3375 or 3380 with RPS

When the sector address is known or can be calculated, the following channel program can be used.

<b>Command</b>	<b>Block Multiplexer Channel and Storage Director Status</b>
Seek	Available when the storage director accepts the seek address.
Set Sector	Available during access movement and until sector is located.
Search ID Equal	Busy.
TIC *-8	Normally the first ID read is the required record and the TIC is not executed.
Read Data	Busy.

The channel and storage director are available during access motion and rotational positioning, allowing seek and set sector operations to be overlapped with other I/O operations on the storage director and channel.

# Channel Program

- Seek**                 Selects the proper cylinder and head.
- Search ID**         Reads the ID of each record.
- Equal (Rn)**
- TIC \*-8**            Branches back to the Search ID  
Equal command until Rn is located,  
then branches to the Write Data command.
- Write Data**         Transfers the data from main storage  
and writes it in Rn.
- Read Sector**        Reads and stores the sector number of  
Rn (42).
- Set Sector**         Transfers the sector number of Rn (42) to  
the storage director. The channel disconnects  
until the target sector is located. It is available  
for other operations during this period. If the  
channel is not available when the target sector  
is located, the storage director tries to  
reconnect on the next revolution.
- Search ID**         Reads the ID of each record.
- Equal (Rn)**
- TIC \*-8**            Branches back to the Search ID  
Equal command until Rn is located, then  
branches to the Read Data command.  
Normally, the first ID read is the required  
record and the TIC is not executed.
- Read Data**         Transfers the data from record Rn to  
main storage where it is compared with the  
original data from the Write Data command.

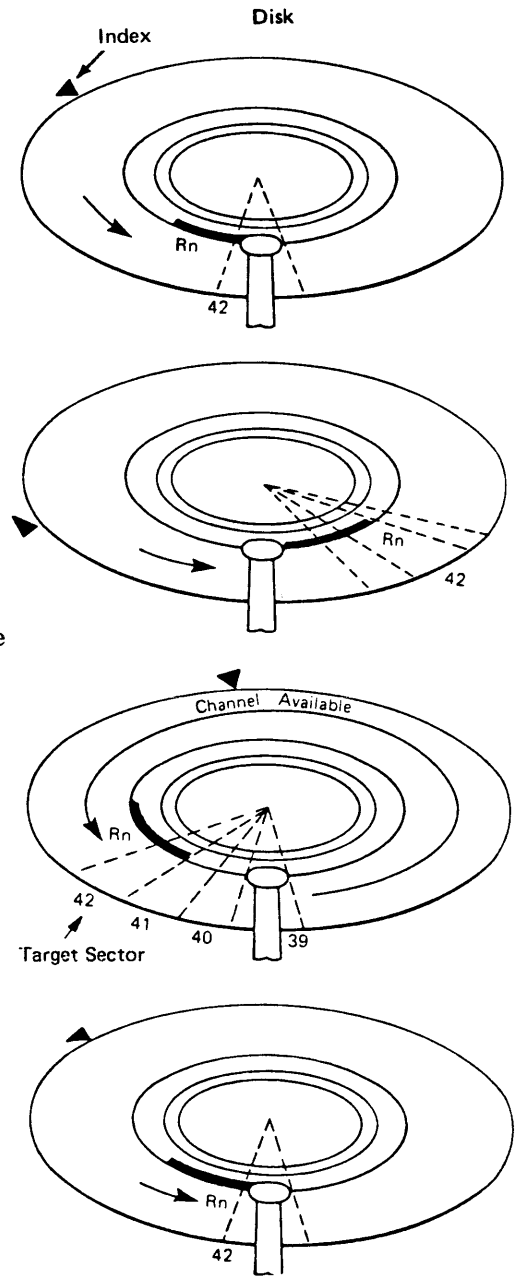

Figure 5-4. RPS for Write Verification

## Command Retry

Command retry (a standard feature) is a combined channel and storage director procedure that allows a command in a channel program to be re-executed without causing an I/O interrupt. Retry is requested when the storage director sends retry status (unit check with channel end and/or device end and status modifier) to the channel. Command retry procedures are device dependent and are not implemented in the same manner for all devices attached to the 3880. In some applications command retry is not carried out but the retry status is used to orient the CCW address to the proper main storage location for the system error recovery procedures.

Command retry procedures that apply to 3330, 3350, 3375, and 3380 disk storage are described in the Command Retry – 3330, 3340/3344, 3350, 3375, and 3380 section of this manual; command retry procedures for the 3370 are described in the Command Retry – 3370 section of this manual.

## Channel Switching

Four channel-switch features are available with the 3880:

- The *two-channel switch* feature (3880 Model 4 only) allows the storage director and its attached drives to be shared by two channels. Different channels can be switched to the storage director.
- The *two-channel switch pair* feature allows each storage director and its attached drives to be shared by two channels. Different channels can be switched to each storage director.
- The *two-channel switch pair, additional* feature allows each storage director and its attached drives to be shared by four channels. Different channels can be switched to each storage director. The two-channel switch pair feature is a prerequisite for this feature.
- The *eight-channel switch* feature allows both storage directors and their attached drives to be shared by eight channels. The same eight channels must be switched to both storage directors. The two-channel switch pair and the two-channel switch pair, additional features are prerequisites for this feature.

The channels may be attached to the same or different processing units and, with appropriate programming or operator action, individual drives may be reserved for the exclusive use of any of the channels.

Channel switching and device reservations are controlled by the channel program. Three special commands are associated with the channel switching features: Device Reserve, Device Release, and Unconditional Reserve.

Two Enable/Disable switches are added to the operator panel for the two-channel switch pair feature; four more are added for the two-channel switch pair, additional feature; and eight more are added for the eight-channel switch feature.

## Channel Selection Switch

Channel selection is controlled by a logical switch in the storage director. When the switch is in the neutral position, the storage director can be selected by any channel.

Once a storage director has been selected by a channel, it is switched to that channel until the channel disconnects. The channel selection switch then returns to the neutral position unless:

- Chaining is indicated and device end is included in the status. (The channel does not disconnect in this case.)
- Chaining is indicated without device end in the status, the channel disconnects, and the storage director becomes busy to allow execution of an ERP, Diagnostic Load command or Diagnostic Write command.
- Chaining is indicated and a storage director controlled format-write operation is in progress.
- The last status byte was part of a channel signal sequence and was stacked by the channel.
- A contingent connection is established.
- Ending status associated with an interface disconnect has not been accepted by the channel.

## Remote Switching

The remote switch features are special features that remove the Enable/Disable switches from the 3880 operator panel and relocate them to a remote location. This allows an operator to reconfigure the system from a central point.

Some systems (for example, S/370 Models 158 and 168) provide a remote configuration control panel for the switches. If the system is not equipped with a remote panel, the customer must provide a suitable panel for mounting the switches.

- The *remote switch* feature is used when attaching to a single channel with the two-channel switch pair feature.
- The *remote switch additional* feature is used with the two-channel switch pair, additional feature.
- The *remote switch for eight-channel switch* is used with the eight-channel switch feature.

## Statistical Usage and/or Error Recording

Each storage director maintains a statistical data record of usage and error information for each attached logical device. The usage information provides an accumulated count of the number of access motions and the number of bytes read or searched for each device. The error information includes the accumulated counts of the number of ECC uncorrectable data errors retried, ECC correctable data errors retried, access motions retried, command overruns, and data overruns.

Usage and error information is maintained for each channel that has access to the attached devices. This information is off-loaded to the system when the counters reach a predetermined level or when a Read and Reset Buffered Log command is executed. When a counter is off-loaded to the system, it is reset to zero in the storage director.

For 3370 devices, the usage information also includes an accumulated count of the number of access movements, data blocks read, and data blocks written with write verify specified. The error information also provides the total number of seek errors, correctable data errors, and uncorrectable data errors.

For 3375 and 3380 devices, temporary seek checks and temporary data checks are logged when a predetermined error rate is exceeded. When the error rate is exceeded, logging mode is set. Error conditions and sense data related to the next series of error conditions of the same type are presented to the system for logging in SYS1.LOGREC.

Statistical usage and/or error recording is a standard feature.

## Error Detection and Logging

Failures that occur during execution of channel commands are indicated in unit status. Other failures are presented to the system through the alternate storage director or cause a channel check. If one of the storage directors in the 3880 fails, error sense information related to the failing storage director is transferred to the system through the other storage director.

Some error conditions and sense information presented to the system by the 3880 are saved in the operating system error log. (See the Logged column in the Error Condition Table.) The EREP program is used to format, summarize, and print the system recorded error information.

## Block Multiplexing

Block multiplexing is a standard feature that allows a storage director to disconnect from the channel during mechanical delays such as repositioning of the access mechanism or rotational delay.

During execution of Seek, Set Sector, Locate, and Diagnostic Control commands, the storage director is allowed to disconnect from the channel between channel end and device end status. The storage director attempts to reconnect when the access motion is completed and/or the desired rotational position is detected.

While the storage director is disconnected from the channel, the processing unit is free to initiate I/O operations on other devices attached to the storage director even though the disconnected channel program is not complete. This allows separate channel program to operate concurrently on each drive attached to the storage director.

## Speed Matching Buffer for 3375

The speed matching buffer for 3375 feature allows 3375s to attach to block-multiplexer channels that operate at data rates as low as 1.5 megabytes per second or at data rates greater than the 1.859 megabyte per second data rate of the 3375. This feature is required to attach 3375s to System/370 Models 145, 148, 155, 158, 158-3, 165, 168, 168-3, and to block-multiplexer channels without data streaming on the 3031, 3032, 3033, and 3042 Model 2.

The 3375s can also be attached to the high-speed channel on the 4331 Model Group 2 Processor, the 2 or 3 megabyte per second block-multiplexer channels on the 4341 Processor, the 3 megabyte per second block multiplexer on the 3081 Processor, and block-multiplexer channels with the data streaming feature on the 3031, 3032, 3033, and 3042. The speed matching buffer feature is only required for these channels if the 3375s are shared with a 1.5 megabyte channel.

If, through use of a channel-switch feature, the 3375 is attached to a channel with a data rate faster than 1.859 megabytes per second and a slower channel, the speed matching buffer feature supports the faster channel at the 3375 data rate of 1.859 megabytes per second, and the slower channel at a data rate of 1.5 megabytes per second.

3375s attached to two storage directors may be configured so that each storage director is buffered or unbuffered independently of the other storage director. However, if both storage directors attach to the same processor, both storage directors must have the speed matching buffer feature or neither can have it.

## Speed Matching Buffer for 3380

The speed matching buffer for 3380 feature allows 3380 Models AA4, A04, and B04 to attach to block-multiplexer channels with a data rate less than 3 megabytes per second. The speed matching buffer can be installed in one storage director in a 3880 Model 2 or either one or both storage directors in a 3880 Model 3. This feature is required to attach 3380s to System/370 Models 158 and 168 and to block multiplexer channels without data streaming on the 3031, 3032, 3033, and 3042.

The speed matching buffer is not supported for 3380 Model AD4/BD4, AE4/BE4, AJ4/BJ4, and AK4/BK4.

If, through use of a channel switch feature, a storage director is attached to a 3-megabyte channel and a slower channel, the speed matching buffer supports the 3-megabyte channel at a 3-megabyte data rate and the slower channel at a 1.5-megabyte data rate.

When both paths of 3380 with the dynamic path selection function are attached to a single processor, both storage directors must have the speed matching buffer feature or neither can have it.

## I/O Operation for Speed Matching Buffer

The speed matching buffer for the 3375 feature and the speed matching buffer for the 3380 feature (Models AA4, A04, and B04 only) will correctly execute standard command chains when connected to channels slower than the 3375 or the 3380. However, a performance reduction on write operations (described below) will occur.

**Write Operations:** When write operations are carried out with a channel that is slower than the device and the channel has not been notified through use of the Define Extent and Locate Record commands, each write command causes a loss of one revolution of the disk. When a Locate Record command is used to convey intent to write, no revolution loss occurs. The sector target supplied by the Locate Record command is adjusted earlier and, at later reconnection, the channel program is advanced through the write command(s) to fill the buffer with write data before it is needed by the device.

When a storage director with the speed matching buffer for the 3375 feature or the speed matching buffer for the 3380 feature is connected to a channel operating at the same speed as the 3375 or the 3380, the performance of the device is realized as long as the channel remains in synchronization. When the intent to write is given through use of the Define Extent and Locate Record command, no adjustment of the starting point for channel operation is done. The channel and device are started at the same time and place on the track.



**Read Operations:** When a Locate Record command indicates that a read operation (on a slow channel) is to follow, no unique action occurs. Data from the track enters the buffer sequentially, starting with the record specified in the previous Locate Record command.

When a storage director with the speed matching buffer for the 3375 or the 3380 feature is connected to a channel operating at the same speed as the 3375 or the 3380, read operations execute at the 3375 or 3380 data rates.

When a Locate Record command is not used, buffer filling starts with the record processed by the first read or search command.

**Programming Considerations** The following should be taken into consideration when developing channel programs for the speed matching buffer for the 3375 or 3380 features.

- Performance can be significantly affected by the way the Locate Record commands are used in the channel program. For example, two channel programs might be constructed to read or write two consecutively addressed records on a track. The first channel program consists of a single Locate Record command followed by two read or write commands. The other channel program consists of two Locate Record commands, each of which is followed by a single read or write command. While both channel programs provide the same function, the second channel program will always take longer to execute. This is because the storage director, after transferring the first record, must transfer and validate another Locate Record parameter list and position the device to begin transfer of the second record. The transfer of the second record may be delayed up to a full revolution of the disk.
- Channel programs for the speed matching buffer feature let the CCW address pointer in the channel advance ahead of the actual CCW command execution in the storage director. An error in executing a command may be indicated as unit check status in some following command. These are either permanent errors or errors where the ERPs will restart the program at the beginning of the original chain. Although no adverse effects are experienced for these cases, there may be a possibility of misinterpreting the dumps or error logs.
- Interruptions requested by the PCI flag may occur at different times, with respect to the transfer of data between the device and storage control, than PCI interrupts in operations without the speed matching buffer for the 3375 or 3380 features.
- Data chaining should not be attempted for Write Key and Data (0D) and Write Update Key and Data (8D) when these commands are within a Locate Record command domain for speed matching buffer operations. When write data is transferred in advance for operations with a channel slower than the device, the boundary between the key and data fields is not known to the storage control. Therefore, the speed matching buffer cannot provide enough pause between the key and data fields to allow time for the channel hardware to carry out the data chaining. Data overruns or chaining checks may occur if data chaining is used under these conditions.

## Chapter 6. Error Recovery Procedures

The error recovery procedures contain an error condition table and a recovery action table for each type of device that attaches to the 3880. The error condition table identifies all unique configurations of the sense bits in sense bytes 0, 1, and 2. Each configuration has a specific recovery action that is invoked by the system. The recovery action table specifies the action to be taken for each error condition. The recovery action and error condition tables for each device are located after the sense byte descriptions for the device. (The 3330 and 3350 recovery action and error condition tables are combined and are located after the 3350 sense byte descriptions.)

### Console Error Message

The console error message should be printed for all permanent errors and should contain the:

- Message code
- Error type (read, write, or control)
- Module designation (drive address), cylinder number, and head number (seek address)
- Status and sense bytes sent to the processor.

### Error Correction Function – Fixed Block Devices

The device recovery action tables use the error correction function as a step in recovering correctable data errors that may occur in the data area of a record.

When the correctable and data check sense bits are presented in the sense information, sense bytes 18 through 23 provide error pattern and displacement information. Error correction is accomplished by aligning the error pattern in sense bytes 20 through 23 with the erroneous data in main storage and exclusive ORing the data.

The location of the erroneous data in main storage is determined by the displacement information in sense bytes 18 and 19, and by the counts provided in the interrupt CCW chain. The storage director specifies the location of the error bytes relative to the first byte transferred in the operation. The displacement between the first byte transferred and the first byte in error is calculated by multiplying the number of blocks transferred (sense bytes 16 and 17) by 512 to obtain the restart displacement and subtracting the error displacement provided in sense bytes 18 and 19. The result is the forward error displacement which is used, with the count specified in the interrupted CCW, to find the erroneous data in main storage.

If data chaining was indicated in the operation that presented the correctable error, the forward displacement may reference data from the second (or subsequent) CCW in the chain. The channel automatically ensures that the indicated CCW address points to the interrupted CCW + 8.

The error correction function is bypassed for bytes that were not transferred to main storage because the skip bit was on or there was a short CCW count.

If the indirect address bit is on during the operation that presented the correctable error, the first data address is obtained from the first indirect address word (IDAW). The CCW data address points to the IDAW, and correction proceeds as described for data chaining.

### Example

In this example, the indicated CCW address minus 8 points to CCW 2 in the following chain:

CCW	Command	Address	Count	Flags
1	Locate	A	8	Command chaining
2	Read	B	1024	Data chaining
3	TIC	CCW 4	—	—
4	Read	D	6	Suppress incorrect length

The error affects bytes 6 and 7 of the first block of data transferred by CCW 4 as follows:

Byte 6 - - - - - XX

Byte 7 X - - - - -

Where (-) corresponds to a correct bit .

(X) corresponds to an incorrect bit

The illustrated condition generates the following error correction information:

Sense bytes 16 and 17 = 3 (block count)

Sense bytes 18 and 19 = 507 (error displacement)

Sense bytes 20 and 21 = 0000 0011 and 1000 0000 (error pattern)

Application of the error correction function, as outlined in the preceding sections, results in the following system recovery action.

1. Sense byte 20 (pattern byte 1) is exclusively ORed with main storage location D + 5.
2. Sense byte 21 (pattern byte 2) does not apply to data byte 7 of the third block because of the short count in CCW 4.

## Restart CCWs – Fixed Block Devices

If operation incomplete (byte 1, bit 7) is set in the sense information, it indicates that an error or unusual condition occurred during a logical operation after data transfer had been initiated. By building restart CCWs, the error recovery procedures are able to correct the unusual condition and continue the current operation from the point of interruption to the normal ending point.

### Restart CCW 1

Build restart CCW 1 as follows:

1. If sense byte 8, bit 7 equals 0, set the restart command code to X'42'; otherwise, set it to X'41'.
2. Use the data address of the interrupted CCW, plus the count of that CCW, minus the residual count.
3. Use the flags (except PCI) of the interrupted CCW.
4. Use the residual count for the count field of restart CCW 1. If the residual count is zero, a count of one must be used and if a write command was in progress, the data address must specify a byte containing X'00'. If a read command was in progress, the skip bit must be on.

### Restart CCW 2

Build restart CCW 2 as follows:

1. If sense byte 8, bit 7 equals 0, set the restart command code to X'42'; otherwise, set it to X'41'.
2. Build the count.
  - a. Fetch the byte count of the CCW determined by the indicated CCW address minus 8, designate it COUNT, and set a pointer to it.
  - b. Set T equal to the number of blocks derived from COUNT. Set N equal to the number of blocks transferred as indicated in bytes 16 and 17. If  $T - N > 0$ , go to step f; otherwise, go to step c.
  - c. Check the chain data flag of the CCW designated by the pointer. If the flag is off (truncation occurred), go to step e; otherwise, go to step d.
  - d. Advance the pointer to the next non-TIC CCW in the data chain and add the count of the CCW to the counts of all preceding non-TIC CCWs in the data chain. Return to step b.
  - e. Set the restart CCW 2 count equal to 1. Go to step 3.
  - f. Set the restart CCW 2 count equal to  $COUNT - N \times 512$ . Go to step 3.

3. Use the flags (except PCI) of the CCW designated by the pointer in step 2. Set the skip bit if step 2e was executed and the operation was read.
4. Use the data address of the CCW designated by the pointer in step 2, plus the count of that CCW, minus the restart CCW count built in step 2. If step 2e was executed and the interrupted operation was a write, the data address must specify a byte containing X'00'.

If another operation incomplete occurs while executing the restart CCW, a new restart CCW may be generated from the old restart CCW. Do not destroy the old restart CCW before attempting to build the new one.

### **Error Correction Function – Count, Key, and Data Devices**

The following description of the error correction function applies to 3330, 3333, 3340, 3344, 3350, 3375, and 3380 disk storage.

The recovery action tables use an error correction function as a step in recovering from data errors. The error correction function is used when the storage director posts the data check and correctable sense bits in the sense information. These bits are presented if a correctable data error is detected in any data area.

Correctable data errors in home address, count, and key areas on 3330s, 3333s, 3375s, and 3380s are corrected internally by the storage director using command retry. Data check and correctable sense bits are not presented for these errors and do not cause a system interrupt.

When the correctable and data check sense bits are included in the sense information, sense bytes 18 through 22 (21 for 3375; 23 for 3380) in format 5 provide the error pattern and displacement. Error correction is accomplished by aligning the error pattern provided in sense bytes 20 through 22 (21 for 3375; 23 for 3380) with the erroneous data in main storage and exclusively ORing the error pattern and main storage bytes.

The location of the erroneous data in main storage is determined by using displacement information provided in the sense bytes and the counts provided in the interrupted CCW chain. The storage director specifies the location of the error bytes, relative to the first byte transferred in the operation that incurred the error. The displacement between the first byte transferred and the first byte in error is calculated by subtracting the error displacement provided in sense bytes 18 and 19 from the restart displacement provided in sense bytes 15 through 17. The result constitutes the forward error displacement and is used with the count specified in the interrupt CCW, to locate the erroneous main storage data.

If data chaining was indicated in the operation that presented the correctable error, the forward displacement may reference data from the second (or subsequent) CCW in the data chain.

If the indirect address bit is on during the operation that presented the correctable error, the first data address is obtained from the first indirect address work (IDAW). The CCW data address points to the IDAW, and correction proceeds as described for data chaining.

Before applying the error correction function, determine whether any error bytes were not transferred because the skip bit was on, there was a short count in the CCW, or if the error bytes are not in adjacent main storage locations because of data chaining between CCWs.

- If any of the error bytes are in data specified by a CCW with the skip bit on, the error correction function cannot be used for the bytes that were not transferred to main storage.
- If any of the error bytes are in data not transferred to main storage because of a short CCW count, the error correction function cannot be used for the bytes that were not transferred to main storage.
- If no short CCW count is found and bit 7 of sense byte 23 indicates that a channel truncation occurred (3330 only), the error correction function cannot be applied correctly.
- If the error pattern covers non-adjacent main storage boundaries because of data chaining, the error correction function must be selectively applied to the separate storage locations.

Except for 3375 and 3380, if the error displacement in sense bytes 18 and 19 is less than 3, the error is partially or totally contained in the correction code bytes. The error pattern in sense bytes 20 through 22 is then built as follows:

1. If the error displacement is zero, or if the error is totally contained in the gap that immediately precedes the data area, the error pattern must be set to zero by the error recovery procedures.
2. If the error displacement is one, the two low-order error pattern bytes (bytes 21 and 22) must be set to zero by the error recovery procedures. The high-order bytes contain the correction syndrome.
3. If the error displacement is two, the low-order pattern byte must be set to zero by the error recovery procedures. The high-order bytes contain the correction syndrome.

## Example

In this example, the key length is 2, the data length is 10, and the error pattern is 3 bytes long.

The indicated CCW address minus 8 points to CCW1 in the following chain:

CCW	Command	Address	Count	Flags
1	Read Key and Data	A	2	Data chaining
2	TIC	CCW 3	-	-
3	-	B	4	Data chaining, skip
4	-	C	1	Suppress incorrect length

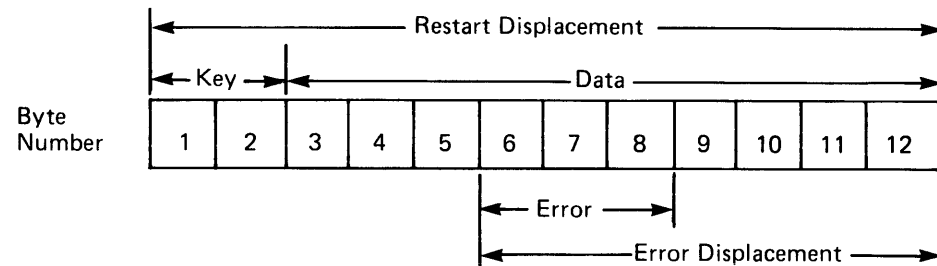

The error affects bytes 6, 7 and 8 as follows:

Byte 6 - - - - - XX

Byte 7 X X X - - - - -

Where (-) corresponds to a correct bit

(X) corresponds to an incorrect bit

The illustrated condition generates a restart displacement of 12 and an error displacement of 7. The following error pattern is produced.

Pattern byte 1 (sense byte 20) 0 0 0 0 0 0 1 1

Pattern byte 2 (sense byte 21) 1 1 1 0 0 0 0 0

Pattern byte 3 (sense byte 22) 1 0 0 0 0 0 0 0

Application of the error correction function, as outlined in the preceding sections, results in the following system recovery action.

1. Pattern byte 1 does not apply to data byte 6, since this byte is not transferred to main storage because of the skip flag in CCW 3.
2. Pattern byte 2 is exclusively ORed to main storage location B, where data byte 7 resides.
3. Pattern byte 3 does not apply to data byte 8, since this byte is not transferred to main storage because of a short count in CCW 4.

## Restart CCWs – Count, Key, and Data Devices

If operation incomplete (byte 1, bit 7) is set in the sense information, it indicates that an error or unusual condition occurred during a logical operation after data transfer had been initiated. By constructing restart CCWs, the error recovery procedures are able to correct the unusual condition and continue the current operation from the point of interruption to the normal ending point. (3375s and 3380s do not support record overflow so byte 1, bit 7 is not set. However, restart CCW 2 is used after a data check on a Read Multiple CKD command.)

The recovery action table specifies the restart CCW required, either 1 or 2.

### Restart CCW 1

Build restart CCW 1 as follows:

1. Use the command code byte provided in sense byte 3. For errors associated with Read Multiple CKD commands, step 1 is not used. The recovery actions specify a specific command code to be used.
2. Use the data address of the interrupt CCW, plus the count of that CCW, minus the residual count.
3. Use the flags (except PCI) of the interrupted CCW.
4. Use the residual count for the count field of CCW 1. If the residual count is zero, a count of one must be used, and if a write command was in progress, the data address must specify a byte containing X'00'. If a read command was in progress, the skip bit must be on.

### Restart CCW 2

Build restart CCW 2 as follows:

1. Use the command code provided in sense byte 3. For errors associated with Read Multiple CKD commands, step 1 is not used. The recovery actions specify a specific command code to be used.
2. Build the count as follows:
  - a. Fetch the count of the CCW designated by the indicated CCW address minus 8, and set a pointer to this CCW.
  - b. Subtract the restart displacement from the count obtained in step a. If this result is positive, go to step f; otherwise, go to step c.
  - c. Check the chain data flag of the CCW designated by the pointer. If the flag is not set (truncation occurred), go to step e; otherwise, go to step d.



- d. Advance the pointer to the next non-TIC CCW in the data chain and add the count of this CCW to the counts of all preceding non-TIC CCWs in the data chain. Return to step b.
  - e. Set the restart CCW 2 count to 1. Go to step 3 and include the skip bit in the restart CCW flags.
  - f. Set restart CCW 2 count equal to the result of the subtraction in step b. Go to step 3.
3. Use the flags (except PCI) of the CCW designated by the pointer in step 2. Set the skip bit if step 2e was executed.
  4. Use the data address of the CCW designated by the pointer in step 2, plus the count of that CCW, minus the restart CCW count generated in step 2. If step 2e was executed and the interrupted operation was a write, the data address must specify a byte containing X'00'.

If another operation incomplete or an error in a Read Multiple CKD command occurs while executing the restart CCW, a new restart CCW may be generated from the old restart CCW. Return to step 2d, but do not destroy the old restart CCW before generating the new one.

## Command Retry – 3370

Command retry is used to recover from the following error conditions.

- When a correctable data error occurs in the data area of a record, command retry is used to orient the system error recovery procedures to the first CCW of the chain in which the error occurred. The data error is corrected through use of the sense information, and the chain is restarted under control of the error recovery procedures.
- When an uncorrectable data error occurs in the first block during a read operation, the command is retried until the error is corrected, or until it is determined that the error cannot be corrected.
- When an uncorrectable data error is detected in any other block, command retry is used to cause the system error recovery procedures to build a restart CCW chain which begins reading from the block that was in error.
- When a seek error is detected or seek incomplete is signaled in the sense information, the storage director retries the seek until the access mechanism is positioned correctly or until it is determined that the error is permanent. If the error is permanent, the sense information indicates a permanent seek error.

- When a command overrun occurs, the storage director establishes reorientation and retries the command.
- When a service overrun occurs in the first block during a read or write data operation or in any block during a write and check data operation, the storage director retries the operation until it recovers from the error condition or it determines that the error is permanent.

If the error is permanent, the sense information indicates an overrun and a permanent error. If a service overrun occurs in the data area of any block except the first during a read- or write-without-check data operation, command retry is used to orient the error recovery procedures to the correct CCW and the system error recovery procedures are used to restart the command chain.

### **Internal Retry**

Internal retry is a storage director procedure that causes some operations to be retried without an I/O interrupt or channel assistance.

Internal retry is used for the following conditions:

- When a defective or alternate block is detected during a read or write operation, the storage director accesses to the correct position and continues the operation in progress.
- If an error is detected in the block ID field, the storage director reorients to the failing block and repeats the operation until the error is corrected.

If the error cannot be corrected, sense information indicates data check, permanent error, and uncorrectable block ID.

- When a seek error is detected during execution of a format defective block, check data, or format block ID operation, the storage director repositions the access mechanism to the desired track and retries the seek until the error is corrected, or until it is determined that the error cannot be corrected. If the error cannot be corrected, the sense information indicates equipment check, permanent error, and seek check. The storage director attempts to recover from the error by using the system error recovery procedures.

## Command Retry – 3330, 3340/3344, 3350, 3375 and 3380

Command retry is used to recover from the following error conditions.

- When a correctable data error occurs during a read or search operation on a home address, count, or key area on 3330, 3375, or 3380 devices.
- When a correctable data error occurs in the data area of a record on a 3330, 3340/3344, 3350, 3375, or 3380, command retry is used to orient the system error recovery procedures to the first CCW of the chain in which the error occurred. The data error is corrected by use of the sense information and the chain is restarted under control of the error recovery procedures.
- When an uncorrectable data error is detected in any field during a read or search operation, the command is retried until the error is corrected or until it is determined that the error cannot be corrected.
- When a defective or alternate track is detected before data transfer has started, the storage director issues a seek to the appropriate track, orients on index, and reissues the command.
- When a seek error is detected or seek incomplete is signaled by the device, the storage director retries the seek until the access mechanism is positioned correctly, or until it is determined that the error is permanent. If the error is permanent, the sense information indicates equipment check, permanent error, and seek check.
- When a command overrun occurs, the storage director retries the last command.
- When a data overrun occurs, the command is retried (unless the data overrun occurred during the second or following segment of an overflow record, during a format write operation, or during a Read Multiple CKD command).
- When command retry is used to allow the channel to disconnect during some padding operations, and to reconnect on completion of padding.
- When command retry starts a seek operation previously received from the channel but not initiated by the device. If a Space Count, Diagnostic Write Home Address, read, or search command is received, the storage director disconnects from the channel, seeks to the specified track, and reissues the command.

Execution of command retry may cause the following conditions to be detected by the channel program:

- A CCW containing a PCI may, if retried because of command retry, cause multiple PCI interruptions to occur.
- A channel program consisting of a single, unchained CCW specifying an immediate command may cause a condition code of 0 rather than 1 to be set. This condition code is set if the storage director signals command retry at the time initial status is presented to the channel. The channel program then causes a later interruption on completion of the operation.
- If a channel program stops prematurely during a command retry, the residual count and indicated CCW address field may not necessarily indicate the extent of main storage used.
- If a CCW used in an operation is changed before that operation has been successfully completed, the results are unpredictable.

When the speed matching buffer for 3375 or 3380 is installed in the 3880, command retry is also used:

- To reposition and write after receiving a write operation when write intent has not been specified. (Applies to operation on a slow channel only.)
- To reposition and write a group of records when the write intent covers a specified number of records whose total byte length exceeds the buffer capability. (Since the buffer is used in a wraparound manner, the capability of the buffer is greater than the capacity of the buffer.) The group of records is the number of consecutive records that can be handled at one time. (Applies to operation on a slow channel only.)
- To reposition and resume reading when the buffer capability has been exceeded. (Applies to operation on a slow channel only.)
- To position to the next cylinder when required by a data transfer operation within the domain of a Locate Record command.
- When a track switch has occurred at index but the channel program specifies continuing on the original track (applies to operation on a slow channel only).
- To reposition and retry a format write command after a data overrun occurs within the domain of a Locate Record command.

## Device Support Facilities

The Device Support Facilities program carries out various error handling functions for use by operations personnel. This program exercises hardware, checks disk surfaces, assigns chip defects, assigns alternate tracks or blocks, rewrites home addresses and record zeros.

Guidance on error handling for system programmers can be found in the following publications:

- *IBM Disk Storage Management Guide* describes data and equipment errors that can occur in disk storage operations. It also includes the *IBM Disk Storage Management Guide, Error Handling* and *IBM Disk Storage Management Guide, Background Reference Information*. It also provides tutorial information on the Environmental Recording, Editing, and Printing (EREP) program System Exception reports.
- *IBM Reference Summary for Handling Data Checks*, pocket-size card containing information extracted from the *IBM Disk Storage Management Guide, Error Handling* manual.
- *Device Support Facilities User's Guide and Reference* describes the Device Support Facilities program product.

The following manuals should be read for information on using the subsystem efficiently and for maintaining disk storage media:

- *IBM 3380 Direct Access Storage Device Introduction*
- *Using 3380 DAS in a MVS Environment*
- *Using 3380 DAS in a VM Environment*
- *Using 3380 DAS in a VSE Environment*
- *Maintaining Storage Subsystem Media.*

## Chapter 7. Sense Bytes – 3370

Sense information for the 3370 (24 bytes) identifies the conditions that caused the last unit check status to be generated. The sense information also provides secondary information for system error recovery and for diagnosing and isolating storage director and device malfunctions.

### Sense Byte 0

#### Bit 0 - Command Reject

Bit 0 is set by:

- An invalid command code
- An invalid command sequence
- An invalid or incomplete argument transferred by a control command
- Issuing a format write command with the Write Inhibit switch in the Read-Only position
- Issuing a format write command that violates the define extent mask
- Issuing a Locate command with a format defective block specified in the operation byte, and space in the alternate area has been exhausted. Byte 1, bit 7 (operation incomplete) is also set.
- Issuing a Locate command with write data specified in the operation byte and the define extent mask inhibits all write operations
- An invalid or incomplete argument transferred by a Diagnostic Control command.

#### Bit 1 - Intervention Required

Bit 1 is set by:

- Addressing a drive that is not attached to the system
- Addressing a drive that is not ready.

**Bit 2 - Bus Out Parity**

Bit 2 is set when a parity error is detected during the transfer of a command or data from the channel to the 3880.

**Bit 3 - Equipment Check**

Bit 3 is set when an unusual hardware condition occurs in the channel, storage director, controller, or drive. The condition is further defined in sense bytes 7 through 23.

**Bit 4 - Data Check**

Bit 4 is set when the storage director detects a data error in the information received from the drive. If byte 2, bit 1 (correctable) is also set, the error is correctable and bytes 16 through 23 provide correction information. If the data error is uncorrectable, sense byte 7 defines the specific nature of the condition.

**Bit 5 - Overrun**

Bit 5 is set when the storage director does not receive a response to a data request within a specified period of time. Detection of an overrun stops data transmission. When writing, the remaining portion of the record area is padded with zeros. Byte 1, bit 7 (operation incomplete) is also set.

**Bit 6**

Bit 6 is not used. It is set to zero.

**Bit 7**

Bit 7 is not used. It is set to zero.

## Sense Byte 1

### Bit 0 - Permanent Error

Bit 0 is set when internal error recovery has been exhausted (through the use of command retry) and was unsuccessful, or when internal error was not possible or desirable.

The bit overrides any other bit settings and indicates that system error recovery procedures may not be required.

### Bit 1 - Block Size Exception

Bit 1 is set when an invalid block size is specified in bytes 2 and 3 of a Define Extent command.

### Bit 2

Bit 2 is not used. It is set to zero.

### Bit 3 - Message to Operator

Bit 3 is set with byte 0, bit 3 (equipment check) to indicate a permanent failure in the alternate storage director or a state save operation in the reporting storage director.

### Bit 4

Bit 4 is not used. It is set to zero.

### Bit 5 - File Protected

Bit 5 is set when a Diagnostic Control or Locate command violates the logical extent limits established by a Define Extent command.

### Bit 6 - Write Inhibited

Bit 6 is set when a write operation is attempted on a drive that has its Write Inhibit switch in the Read-Only position. Byte 0, bit 0 (command reject) is also set.

### Bit 7 - Operation Incomplete

Bit 7 is set when:

- A correctable data check is detected in the data area of any block other than the last block. Byte 0, bit 4 (data check) and byte 2, bit 1 (correctable) are also set.
- An uncorrectable data check is detected in the data area of any block other than the first block. Byte 0, bit 4 (data check) is also set.



- A service overrun is detected in a data area of any block other than the first during a read or update-write operation. Byte 0, bit 5 (overrun) is also set.
- A Locate command has been issued with a format defective block specified in the operation byte, and space in the alternate area is exhausted. Byte 0, bit 0 (command reject) is also set.
- A seek error is detected after the start of data transfer during a multiblock read or write operation.

## **Sense Byte 2**

### **Bit 0 - Check Data Error**

Bit 0 is set when an uncorrectable data check is detected during the read-back verification phase of a Write command with write and check data specified in the preceding Locate command.

### **Bit 1 - Correctable**

Bit 1 is set when the data check condition indicated by byte 0, bit 4 (data check) is correctable.

### **Bit 2 - First Logged Error**

Bit 2 is set to indicate that the error rate for temporary data or seek checks has been exceeded and logging mode has been set for the device.

### **Bit 3 - Environmental Data Present**

Bit 3 is set when:

- An error counter overflows.
- The usage statistics require off-loading.
- A Read and Reset Buffered Log command is executed.

### **Bit 4**

Bit 4 is not used. It is set to zero.

### **Bit 5**

Bit 5 is not used. It is set to zero.

### **Bit 6**

Bit 6 is not used. It is set to zero.

### **Bit 7**

Bit 7 is not used. It is set to zero.

### **Sense Byte 3**

#### **Bits 0 through 7 - Cylinder High**

Bits 0 through 7 identify the high-order cylinder address of the most recent seek.

### **Sense Byte 4**

#### **Bits 0 through 7 - Cylinder Low**

Bits 0 through 7 identify the low-order cylinder address of the most recent seek.

### **Sense Byte 5**

#### **Bits 0 through 7 - Head Address, IAR, or Diskette Checks**

Bits 0 through 7 identify either:

- The head address of the most recent seek. (Operations involving head switching update this byte.)
- The high-order byte of the instruction address register (IAR) (when microcode detected Format 3 is indicated).

With sense Format 6, byte 5 indicates the number of diskette checks after an initial microcode load (IML) or a storage director-to-storage director communication failure.

Bit 0 = Communication failure during an IML	Bits 2–4 = Diskette check (seek errors)
Bit 1 = Not used	Bits 5–7 = Diskette check (read errors)

## Sense Byte 6

### Bits 0 through 7 - Block Number, IAR, or Storage Director ID

Bits 0 through 7 identify the block that was last processed. This byte is valid only when byte 7, bits 0 through 3 specify Format 4 or Format 5. For microcode detected Format 3, byte 6 contains the low-order byte of the IAR. For Format 6, byte 6 identifies the storage director.

## Sense Byte 7

### Bits 0 through 3 - Format

Bits 0 through 3 specify the format of sense bytes 8 through 23 as follows:

- 0000 = Format 0 – program or system check
- 0001 = Format 1 – device equipment check (CE information)
- 0010 = Format 2 – storage director equipment check (CE information)
- 0011 = Format 3 – storage director control checks (CE information)
- 0100 = Format 4 – data check without displacement information  
(uncorrectable data checks)
- 0101 = Format 5 – data check with displacement information (correctable  
data checks)
- 0110 = Format 6 – usage statistics/overrun errors

### Bits 4 through 7 - Message Code

Bits 4 through 7 describe the specific nature of the error conditions for each of the above formats. The message table that accompanies the format descriptions specifies the function of the message bits for the format.

## Format 0 – Program or System Check

Format 0 is used when sense bytes 0 through 7 completely describe an error or unusual condition caused by a program or system error.

### Bytes 8 through 15 - Locate Parameters

When byte 1, bit 7 (operation incomplete) is set and the error was not detected on a Diagnostic Sense command, bytes 8 through 15 contain the updated Locate parameters. Otherwise, these bytes are set to zero.

### Bytes 16 and 17 - Number of Blocks Transferred

When byte 1, bit 7 (operation incomplete) is set and the error was not detected on a Diagnostic Sense command, bytes 16 and 17 contain the number of blocks transferred to the system (excluding the error block). Otherwise, these bytes are set to zero.

### Bytes 18 through 20

Bytes 18 through 20 are not used. They are set to zero.

### Byte 21

Storage director ID.

### Bytes 22 and 23

Symptom code.

## Message Table – Format 0

Sense Byte 7, Bits 4-7 =	Message Code	Message
0000	0	No message. No additional information required.
0001	1	The storage director received an invalid command.
0010	2	The storage director received an invalid sequence of commands.
0011	3	The count specified in the CCW was less than required.
0100	4	The data argument of the command was invalid.
0101	5	A Diagnostic Control command was issued when prohibited by the Define Extent mask.
0110	6	The channel did not indicate chaining when retry status was presented.
0111	7	The command portion of the CCW that was returned after a command retry sequence did not match the command for which retry was signaled.
1000-1011	8-B	Reserved.

<b>Sense Byte 7, Bits 4-7 =</b>	<b>Message Code</b>	<b>Message</b>
1100	C	A Locate command with a format defective block specified in the operation byte was issued when the alternate space was exhausted.
1101	D	A service overrun occurred in the data area.
1110-1111	E-F	Reserved.

## Format 1 – Device Equipment Check

Format 1 is generated when:

- A device, device interface, or a controller equipment check is detected. Byte 0, bit 3 (equipment check) is also set.
- A permanent device seek check is detected. Byte 0, bit 3 (equipment check) and byte 1, bit 0 (permanent error) are also set.
- Error log information is off-loaded after a successful retried seek that occurred during error logging. Byte 2, bit 3 (environmental data present) is also set. The message bits in sense byte 7 indicate a seek error.
- Byte 11, bit 4 (on line) is off. Byte 0, bit 1 is also set.

### Byte 8 - CTL-I Tag Bus

Byte 8 contains the CTL-I tag bus value. This byte is not valid if it is zero. For message code A and if byte 11, bit 2 (drive check) is 0, byte 8 contains the high-order physical cylinder address of the track selected.

### Byte 9 - CTL-I Bus Out

For message codes 2, 4, B, C, D, E, and F, byte 9 identifies the contents of the CTL-I bus out. For message codes 1, 3, 5, 6, 7, 8, and 9, byte 9 contains the expected drive status or data. For message code A and if byte 11, bit 2 (drive check) is 0, byte 9 contains the low-order physical cylinder address of the track selected.

### Byte 10 - CTL-I Bus In

Byte 10 contains the CTL-I bus in value. This byte is not valid if it is zero. For message code A and if byte 11, bit 2 (drive check) is 0, byte 10 contains the physical head address of the track selected.

### Byte 11 - Drive Status

Bit 0 = Controller check	Bit 4 = On line
Bit 1 = Device interface check	Bit 5 = HDA attention
Bit 2 = Drive check	Bit 6 = Busy - not sector compare
Bit 3 = R/W check	Bit 7 = Seek or offset complete or search sector

### Byte 12

Bit 0-5 = Not used
Bit 6 = Device bus out parity check
Bit 7 = Device tag bus parity check

### Byte 13

When byte 11, bit 0 is off:

Bit 0 = Write mode/standby check  
Bit 1 = Capable/enable check  
Bit 2 = Write overrun  
Bit 3 = Index check  
Bit 4 = Control check  
Bit 5 = Select error  
Bit 6 = HDA write check  
Bit 7 = Decode check

When byte 11, bit 0 is on:

Bit 0 = Drive selected 0  
Bit 1 = Drive selected 1  
Bit 2 = Drive selected 2  
Bit 3 = Drive selected 3  
Bit 4 = Drive selected 4  
Bit 5 = Drive selected 5  
Bit 6 = Drive selected 6  
Bit 7 = Drive selected 7

### Byte 14

When byte 11, bit 0 is off:

Bit 0 = Write inhibit  
Bit 1 = 0 - Model A1/B1  
Bit 1 = 1 - Model A2/B2  
Bit 2 = Sector compare check  
Bit 3 = Write select verify  
Bit 4 = Write op OK  
Bit 5 = No select error  
Bit 6 = HDA read check  
Bit 7 = Transition detect check

When byte 11, bit 0 is on:

Bit 0 = Not used  
Bit 1 = Not used  
Bit 2 = Not used  
Bit 3 = Not used  
Bit 4 = Microcontroller check 1  
Bit 5 = Microcontroller check 2  
Bit 6 = CS address parity check  
Bit 7 = PROM store check

### Byte 15

When byte 11, bit 0 is off:

Bit 0 = HDA sequence latch 0  
Bit 1 = HDA sequence latch 1  
Bit 2 = HDA sequence latch 2  
Bit 3 = CE drive motor switch on  
Bit 4 = Selected PLL good  
Bit 5 = DC voltage good  
Bit 6 = Air system good  
Bit 7 = Unselected PLL good

When byte 11, bit 0 is on:

Bit 0 = CTL-I bus out parity check  
Bit 1 = CTL-I tag bus parity check  
Bit 2 = Funnel 0/1 parity check  
Bit 3 = Not used  
Bit 4 = Device bus in parity check  
Bit 5 = Selected interface (0 = A, 1 = B)  
Bit 6 = Transfer check  
Bit 7 = MD bus in parity check

### Byte 16

When byte 11, bit 0 is off:

Bit 0 = Access timeout  
Bit 1 = Overshoot check  
Bit 2 = Servo off track  
Bit 3 = Invalid location

When byte 11, bit 0 is on:

Bit 0 = Control register 3, 4, or 5  
parity check  
Bit 1 = Not used  
Bit 2 = Any FCI register parity check  
Bit 3 = Buffer or control register 16  
or 17 parity check

Bit 4 = Sequence latch 8  
Bit 5 = Sequence latch 4  
Bit 6 = Sequence latch 2  
Bit 7 = Sequence latch 1

Bit 4 = Not used  
Bit 5 = Error alert  
Bit 6 = Not used check  
Bit 7 = Forced error alert

### Byte 17

When byte 11, bit 0 is off:

Bit 0 = Guardband latch  
Bit 1 = Guardband 2 ID  
Bit 2 = Track crossing  
Bit 3 = Velocity polarity latch  
Bit 4 = Even track  
Bit 5 = Fine position  
Bit 6 = End accelerate  
Bit 7 = End decelerate

When byte 11, bit 0 is on:

Bit 0 = SERDES data funnel parity check  
Bit 1 = Counter parity check  
Bit 2 = ECC hardware check  
Bit 3 = VFO not in sync  
Bit 4 = SERDES error parity check  
Bit 5 = SERDES data parity check  
Bit 6 = Write data check  
Bit 7 = Sync-out timing error

### Byte 18

When byte 11, bit 0 is off:

Bit 0 = Direction bit (1 = in)  
Bit 1 = Difference count 512  
Bit 2 = Difference count 256  
Bit 3 = Zero  
Bit 4 = Zero  
Bit 5 = 0 - Model A1/B1  
Bit 5 = 1 - Model A2 controller  
Bit 6 = 0 - Model A1/B1  
Bit 6 = 1 - Model A2/B2  
Bit 7 = 0 - Model A1/B1  
Bit 7 = 1 - Model A2/B2

When byte 11, bit 0 is on:

Bit 0 = Device selection error  
Bit 1 = Microcode detected error  
Bit 2 = Not used  
Bit 3 = Not used  
Bit 4 = Not used  
Bit 5 = Not used  
Bit 6 = Not used  
Bit 7 = Not used

### Byte 19

When byte 11, bit 0 is off:

Bit 0 = Difference/offset 128  
Bit 1 = Difference/offset 64  
Bit 2 = Difference/offset 32  
Bit 3 = Difference/offset 16  
Bit 4 = Difference/offset 8  
Bit 5 = Difference/offset 4  
Bit 6 = Difference/offset 2  
Bit 7 = Difference/offset 1

When byte 11, bit 0 is on:

Bit 0 = Not used  
Bit 1 = Not used  
Bit 2 = Not used  
Bit 3 = Not used  
Bit 4 = Not used  
Bit 5 = Not used  
Bit 6 = Not used  
Bit 7 = Not used



## Byte 20

When byte 11, bit 0 is off:

Bit 0 = Target 128

Bit 1 = Target 64

Bit 2 = Target 32

Bit 3 = Target 16

Bit 4 = Target 8

Bit 5 = Target 4

Bit 6 = Target 2

Bit 7 = Target 1

When byte 11, bit 0 is on:

If byte 18, bit 1 is on, bits 0 through 7 contain the microcontroller error code. If byte 18, bit 1 is off, bits 0 through 7 are not used.

## Byte 21

Bits 0 through 3 are not used. Bits 4 through 7 indicate the following error conditions:

0000 = Not used.

0001 = Tag Valid indication missing on a read or write operation.

0010 = Normal End or Check End indication missing on a read or write operation.

0011 = No Tag Valid, Normal End, or Check End indication received in response to an operation other than a read or write.

0100 = Normal End received before required bytes were transferred.

0101 = Not used.

0110 = Either more than one controller selected or no controller selected.

0111 = Preselection check.

1000 = Unable to determine device type at initial selection.

1001 = Not used.

1010 = Incorrect drive selected.

1011 = Busy missing after seek start issued.

1100 = No block found.

1101 = HDA attention detected during device reconnection for disconnected command chain.

1110 = Preselection bus check.

1111 = Unresetable interrupt.

## Bytes 22 and 23

Bytes 22 and 23 contain the symptom code.

## Message Table – Format 1

Sense Byte 7, Bits 4-7 =	Message Code	Message
0000	0	No message. No additional information required.
0001	1	Transmit target error.
0010	2	Microcode detected error.
0011	3	Transmit difference high error.
0100	4	Sync-out timing error.
0101	5	Unexpected drive status at initial selection.
0110	6	Transmit cylinder address error.
0111	7	Transmit head error.
1000	8	Transmit difference error.
1001	9	Unexpected drive status.
1010	A	Seek error.
1011	B	Seek incomplete on retry.
1100	C	No interrupt from drive.
1101	D	Recovered microcontroller check.
1110	E	Cannot determine cause of an ID miscompare or check end.
1111	F	Microcontroller check.

## Format 2 – Storage Director Equipment Check

Format 2 is generated to provide sense information when the microcode detects a storage director error condition.

<b>Byte 8</b>	Contents of the transfer complete status (XCS) register.
<b>Byte 9</b>	Contents of the transfer error status (XES) register.
<b>Byte 10</b>	Contents of the check register.
<b>Byte 11</b>	Contents of the channel transfer control (CXC) register.
<b>Byte 12</b>	Contents of channel control 2 register.
<b>Byte 13</b>	Contents of the device bus out (DBO) register.
<b>Byte 14</b>	Contents of the device bus in (DBI) register.
<b>Byte 15</b>	Contents of the device tag out (DTO) register.
<b>Byte 16</b>	Contents of the device tag gate (DTG) register.
<b>Byte 17</b>	Contents of the device tag in (DTI) register.
<b>Byte 18</b>	Channel status 2 register.
<b>Byte 19</b>	Not used.
<b>Byte 20</b>	Not used.
<b>Byte 21</b>	Storage director ID.
<b>Bytes 22 and 23</b>	Symptom code.

## Message Table – Format 2

<b>Sense Byte 7, Message</b>		
<b>Bits 4-7 =</b>	<b>Code</b>	<b>Message</b>
0000-0111	0-7	Reserved for other types of storage control units.
1000	8	No message, no additional information required.
1001	9	Selective reset detected while a drive was selected.
1010	A	Failed to latch First Sync In line.
1011-1111	B-F	Reserved.

### Format 3 – Storage Director Control Check (Hardware Detected)

Format 3 is generated to provide sense information for a failing storage director that requires a reset procedure for recovery.

<b>Byte 8</b>	Contents of FRU register 2 (bit 4 = 0).
<b>Byte 9</b>	Contents of check register 1.
<b>Byte 10</b>	Contents of check register 2.
<b>Byte 11</b>	Contents of check register 3.
<b>Byte 12</b>	Not used.
<b>Byte 13</b>	Not used.
<b>Byte 14</b>	Not used.
<b>Byte 15</b>	Contents of FRU register 3.
<b>Byte 16</b>	Contents of FRU register 4.
<b>Byte 17</b>	Not used.
<b>Byte 18</b>	Not used.
<b>Byte 19</b>	Not used.
<b>Byte 20</b>	Not used.
<b>Byte 21</b>	Storage director ID.
<b>Bytes 22 and 23</b>	Symptom code.

### Message Table – Format 3

<b>Sense Byte 7, Bits 4-7 =</b>	<b>Message Code</b>	<b>Message</b>
0000-0111	0-7	Reserved for other types of storage control units.
1000	8	No message. No additional information required.
1001-1111	9-F	Reserved.

### Format 3 – Storage Director Control Check (Microcode Detected)

<b>Byte 8</b>	Not used.
<b>Byte 9</b>	Contents of the transfer error status (XES) register.
<b>Byte 10</b>	Contents of check register.
<b>Byte 11</b>	Contents of the condition register 0 (CRO). register.
<b>Byte 12</b>	Contents of the channel status (CS2) register.
<b>Byte 13</b>	Contents of the channel control 1 (CC1) register.
<b>Byte 14</b>	Contents of the channel control 2 (CC2) register.
<b>Byte 15</b>	Contents of the channel status 1 (CS1) register.
<b>Byte 16</b>	Contents of the channel status 3 (CS3) register.
<b>Byte 17</b>	Contents of the channel transfer control (CXC) register.
<b>Byte 18</b>	Contents of the channel bus out (CBO) register.
<b>Byte 19</b>	Contents of the channel bus in (CBI) register.
<b>Byte 20</b>	Contains the timeout message when sense bytes 22 and 23 contain a symptom code of 3F2X. Otherwise, this byte is the interrupt level.
<b>Byte 21</b>	Storage director ID.
<b>Bytes 22 and 23</b>	Symptom code.

### Message Table – Format 3

<b>Sense Byte 7, Bits 4-7 =</b>	<b>Message Code</b>	<b>Message</b>
0000-0111	0-7	Reserved.
1000	8	Reserved.
1001	9	Channel check 1 or storage director timeout.
1010	A	Trace table saved in this storage director.
1011-1111	B-F	Reserved.

## **Format 4 – Data Checks Without Displacement Information**

Format 4 is generated when:

- Errors were detected in the ID field or errors that were not correctable by the ECC were detected in the data field. This message code in sense byte 7 identifies the field.
- Error log information is off-loaded after an ECC uncorrectable error occurred during error logging. The information was recovered through use of command retry. Byte 2, bit 3 (environmental data present) is also set.

### **Bytes 8 through 15 - Locate Parameters**

If byte 1, bit 7 (operation incomplete) is set, bytes 8 through 15 contain the Locate Parameters. If byte 1, bit 7 is not set or the error was detected during a Diagnostic Sense command, these bytes are zero.

### **Bytes 16 and 17 - Blocks Transferred**

Bytes 16 and 17 contain the number of blocks transferred to the system (excluding the error block).

### **Bytes 18 through 21 - Offset**

Bytes 18 through 21 specify, in blocks, the offset of the error block from the beginning of the media. If the error occurred on a Diagnostic Control command, bytes 18 through 21 contain cylinder address, head address, and the block number.

### **Bytes 22 and 23**

Bytes 22 and 23 contain the symptom code.

## Message Table – Format 4

Sense Byte 7, Bits 4-7 =	Message Code	Message
0000	0	The check byte detected a data error in the ID field.
0001	1	An error occurred in the data area and could not be corrected by the ECC.
0010 and 0011	2, 3	Not used.
0100	4	Data synchronization on the ID field was unsuccessful.
0101	5	Data synchronization on the data area was unsuccessful.
0110-1000	6-8	Not used.
1001	9	An error occurred in the data area during a read-back check of a write and check data operation and it could not be corrected by the ECC.
1010-1100	A-C	Not used.
1101	D	Data synchronization on the data area was unsuccessful and the error occurred during a read-back check of a write and check data operation.
1110 and 1111	E, F	Not used.

## Format 5 – Data Checks With Displacement Information

Format 5 is generated when:

- Data checks that are correctable by the ECC are detected in the data area of a record.
- Error log information is off-loaded after an ECC correctable error occurred during error logging.

### Bytes 8 through 15 - Locate Parameters

If byte 1, bit 7 (operation incomplete) is set, bytes 8 through 15 contain the Locate parameters. If byte 1, bit 7 is not set or if the error occurred during a Diagnostic Sense command, these bytes are zero.

### Bytes 16 and 17 - Blocks Transferred

Bytes 16 and 17 contain the number of blocks transferred to the system (including the error block).

### Bytes 18 and 19 - Error Displacement

Bytes 18 and 19 specify the location of the first data byte in error in the data field. The location is in relation to the end of the data field.

### Bytes 20 through 23 - Error Pattern

These bytes identify the bits in error when the data check is correctable. A 1 in the bit position represents an incorrect bit.

## Message Table – Format 5

Sense Byte 7, Bits 4-7 =	Code	Message
0000	0	Used for all Format 5 data checks.
0001-1111	1-F	Not used.



## **Format 6 – Usage Statistics/Overrun Errors**

Format 6 is generated when:

- A Read and Reset Buffered Log command is executed.
- Usage/error statistics require off-loading due to counter overflow.

### **Bytes 8 through 10 - Blocks Read**

Bytes 8 through 10 contain an accumulated count of the number of blocks read during read operations.

### **Bytes 11 through 13**

Not used. Set to zero.

### **Byte 14 - Access Offset Invoked**

Byte 14 contains the number of times access offset was initiated by the storage director.

### **Bytes 15 through 17 - Blocks Written with Verify**

Bytes 15 through 17 contain the number of blocks written by the 3880 and 3370 with the check data option specified.

### **Byte 18**

Byte 18 is not used.

### **Bytes 19 and 20 - Seeks**

Bytes 19 and 20 contain the number of seeks processed by the 3880 and 3370.

### **Byte 21**

Not used. Set to zero.

### **Byte 22 - Service Overruns**

Byte 22 contains the number of service overruns that occurred.

### **Byte 23 - Command Overruns**

Byte 23 contains the number of command overruns that were retried by the storage director.

## Message Table – Format 6

Sense Byte 7, Bits 4-7 =	Message Code	Message
0000-0111	0-7	Not used.
1000	8	Indicates that the information in bytes 22 and 23 applies to channel A.
1001	9	Indicates that the information in bytes 22 and 23 applies to channel B.
1010	A	Indicates that the information in bytes 22 and 23 applies to channel C.
1011	B	Indicates that the information in bytes 22 and 23 applies to channel D.
1100-1111	C-F	Not used.

**Error Condition Table – 3370**

Byte	Bit	Name	General Description	Action	Logged
0	0	Command reject	Programming error.	2	No
0 1	0 6	Command reject Write inhibited	Write command received with the Write Inhibit switch in the Read-Only position.	1	No
0 1	0 7	Command reject Operation incomplete	Alternate space exhausted.	1	No
0	1	Intervention required	Drive offline.	3	No
0	2	Bus out parity	Bus out parity error occurred.	3	Yes
0	3	Equipment check	Equipment malfunction.	4A	Yes
0 1	3 0	Equipment check Permanent error	Equipment malfunction and command retry exhausted or undesirable.	1	Yes
0 1	3 3	Equipment check Operator message	Permanent equipment malfunction of the alternate storage director or a state save operation in the reporting storage director.	4	Yes
0 1	4 0	Data check Permanent error	Uncorrectable data check and command retry exhausted.	1	Yes
0 1	4 7	Data check Operation incomplete	Uncorrectable data check in a data area of any block except the first during a read operation.	6A	No
0 2	4 1	Data check Correctable	Correctable data check in the last data area during a read operation.	5	No
0 2 1	4 1 7	Data check Correctable Operation incomplete	Correctable data check in the data area of any block except the last during a read operation.	6	No
0 1	5 0	Overrun Permanent error	Command retry exhausted on a service overrun.	1	Yes
0 1	5 7	Overrun Operation incomplete	Service overrun in a data area of any block except the first during a read or write operation with the check data modifier bit off.	6A	No
1	1	Block size exception	Invalid block size specified.	2	No
1	5	File protected	Locate argument violated the Define Extent specifications.	8	No
1	7	Operation incomplete	Seek error after the start of data transfer during a read or update write with the check data modifier bit off.	7	No

Byte	Bit	Name	General Description	Action	Logged
2	0	Check data error	Uncorrectable data check during a check data operation.	4A	Yes
2	3	Environmental data present	Statistical usage/error log information is present.	3	Yes

## Recovery Action Table – 3370

Action	Explanation
1	Print console error message.
2	Exit with programming error or unusual condition indication.
3	a. Repeat the operation once. b. If the error condition persists, do action 1.
4	Print console error message for the operator and/or customer engineer. Go to action 4A.
4A	a. Repeat the operation. b. If the error condition persists after ten retries, do action 1.
5	a. Perform the error correction function. b. Continue the user's chain by executing:  Define Extent (one issued in this command chain) TIC (ICCW Address) (indicated CCW address or next non-TIC CCW in the data chain)
6	a. Perform the error correction function b. Build restart CCW 2. c. Complete the interrupted operation and continue the user's chain by executing:  Define Extent (one issued in this command chain) Locate (parameters from sense bytes 8 through 15) Restart CCW 2 TIC (pointer established while building restart CCW 2 + 8)
6A	a. Build restart CCW 2 b. Complete the interrupted operation and continue the user's chain by executing:  Define Extent (one issued in this command chain) Locate (parameters from sense bytes 8 through 15) Restart CCW 2 TIC (pointer established while building restart CCW 2 + 8)

**Action Explanation**

- 7
- a. Build the restart CCW 1
  - b. Complete the interrupted operation and continue the user's chain by executing:

Define Extent (one issued in this command chain)  
Locate (parameters from sense bytes 8 through 15)  
Restart CCW 1  
TIC (ICCW Address) (indicated CCW address)

- 8
- a. If the blocks specified by the Locate command are not in the user's data set, do action 2.
  - b. If the blocks are within the user's data set, IOS must supply the correct extent limits before issuing the Locate command. Complete the operation by executing:

Define Extent (with modified extent limits)  
TIC (ICCW Address) (indicated CCW address)

## Chapter 8. Sense Bytes – 3330

Sense information for the 3330 (24 bytes) identifies the condition that caused the last unit check status to be generated. The sense information also provides secondary information for system error recovery and for diagnosing and isolating storage director and device malfunctions.

### Sense Byte 0

#### Bit 0 - Command Reject

Bit 0 is set by:

- An invalid command code
- An invalid command sequence
- An invalid or incomplete argument transferred by a control command
- A track formatted without a home address
- Issuing a write command with the Write Inhibit switch in the Read-Only position
- Attempting a format write command (other than Write Home Address or Write R0) on a defective track
- Issuing a write command that violates the file mask
- A record zero count field of a defective track that points to itself instead of the alternate track.

#### Bit 1 - Intervention Required

Bit 1 is set by:

- Addressing a drive that is not attached to the system
- Addressing a drive that is not ready
- Issuing a Diagnostic Write or Diagnostic Load command while an inline diagnostic is resident in control storage.

### **Bit 2 - Bus Out Parity**

Bit 2 is set when a parity error is detected during transfer of a command from the channel to the 3880.

### **Bit 3 - Equipment Check**

Bit 3 is set when an unusual hardware condition occurs in the channel, storage director, or drive. The condition is further defined in sense bytes 7 through 23.

### **Bit 4 - Data Check**

Bit 4 is set when the storage director detects a data error in the information received from the drive. If byte 2, bit 1 (correctable) is also set, the data error is correctable and bytes 15 through 23 provide correction information. Sense byte 7 defines the specific nature of the condition.

### **Bit 5 - Overrun**

Bit 5 is set when the storage director does not receive a response to a data request within a specified period of time.

Detection of an overrun may cause requests for data from the channel to be terminated. When writing, the remaining portion of the record area is padded with a replicated data byte.

All data overrun conditions are retried by the storage director except those that occur in the second or subsequent segments of an overflow record, those that occur during a format write operation, or those that occur during a Read Multiple Count, Key, and Data command.

The storage director presents an overrun only if the condition occurs more than ten times during a CCW chain, or if the overrun occurs during one of the above operations not retried by the storage director.

Command overruns are also retried by the storage director and do not cause an overrun to be presented.

### **Bit 6**

Bit 6 is not used. It is set to zero.

### **Bit 7**

Bit 7 is not used. It is set to zero.

## **Sense Byte 1**

### **Bit 0 - Permanent Error**

Bit 0 is set when internal error recovery has been exhausted (through the use of command retry) and was unsuccessful, or when internal error recovery was not possible or desirable.

The bit overrides any other bit settings and indicates that system error recovery procedures may not be required.

### **Bit 1 - Invalid Track Format**

Bit 1 is set when:

- An attempt is made to write data exceeding track capacity.
- An index point is detected in the gap that precedes a key or data field.
- A previous operation attempted to write data exceeding the track capacity; this operation resulted in a record written into index. This record was encountered while attempting to execute a read, search, or write command. As long as this record remains on the track, invalid track format may be presented while attempting to locate a record successfully written on the track. However, a Search ID will be able to execute on any count field successfully written on the track without presenting invalid track format.

### **Bit 2 - End of Cylinder**

Bit 2 is set when:

- A multitrack read or search operation continues past the end of the cylinder boundary.
- An overflow operation continues past the end of the cylinder boundary. Byte 1, bit 7 (operation incomplete) is also set.

### **Bit 3 - Message to Operator**

Bit 3 is set when there is a permanent failure in the alternate storage director or a state save operation in the reporting storage director. Byte 0, bit 3 (equipment check) is also set. A message will be sent to the operator console. This bit is used for Format 3 only.

### **Bit 4 - No Record Found**

Bit 4 is set when two index points have been detected in the same CCW chain without an intervening read operation in the home address area or data area, or without an intervening write, sense, or control command.



### **Bit 5 - File Protected**

Bit 5 is set when:

- A seek command violates the file mask.
- A multitrack read or search operation violates the file mask.
- An overflow operation violates the seek portion of the file mask. Byte 1, bit 7 (operation incomplete) is also set.

### **Bit 6 - Write Inhibited**

Bit 6 is set either when a write command is received for a drive that has its Write Inhibit switch in the Read-Only position, or when a Diagnostic Control command is issued because of a hardware malfunction. Byte 0, bit 0 (command reject) is also set.

### **Bit 7 - Operation Incomplete**

Bit 7 is set when one of the following conditions occurs during the processing of an overflow record.

- An overflow to a file protected boundary. Byte 1, bit 5 (file protected) is also set.
- An overflow past the cylinder boundary. Byte 1, bit 2 (end of cylinder) is also set.
- A correctable data check is detected in a data field other than the last segment. Byte 0, bit 4 (data check) and byte 2, bit 1 (correctable) are also set.
- An uncorrectable data check is detected in any field in other than the first segment.
- A defective or alternate track condition is detected after the start of data transfer.
- A seek error is detected in the second or subsequent segment.

Sense byte 3 provides the restart command, and sense bytes 8 through 13 in Format 5 provide restart information.

## **Sense Byte 2**

### **Bit 0**

Bit 0 is not used. It is set to zero.

### **Bit 1 - Correctable**

Bit 1 is set when the data check condition indicated by byte 0, bit 4 (data check) is correctable.

### **Bit 2**

Bit 2 is not used. It is set to zero.

### **Bit 3 - Environmental Data Present**

Bit 3 is set to indicate that bytes 8 through 23 contain usage or error statistics, or error log information. Byte 7 indicates the format for bytes 8 through 23.

### **Bits 4 and 5**

Bits 4 and 5 are not used. They are set to zero.

### **Bit 6 - Write Operation**

Bit 6 is set to indicate that an error occurred during execution of a write operation.

### **Bit 7**

Bit 7 is not used. It is set to zero.

## **Sense Byte 3**

### **Bits 0 through 7 - Restart Command**

Bits 0 through 7 are set when byte 1, bit 7 (operation incomplete) is set. These bits identify the type of operation in progress when the interrupt occurred. If the bits are set to 0000 0110, a read operation was in progress; if they are set to 0000 0101, a write operation was in progress.

## Sense Byte 4

### Bits 0 and 1

Bits 0 and 1 identify the physical controller selected.

### Bits 2 through 7 - Drive Identification

Bits 2 through 7 identify the physical address of each drive.

111000 = A	011100 = E
110001 = B	010101 = F
101010 = C	001110 = G
100011 = D	000111 = H

## Sense Byte 5

### Bits 0 through 7 - Cylinder-Low Address

Bits 0 through 7 identify the low-order cylinder address of the most recent seek argument from the channel.

With sense Format 3 (microcode detected), byte 5 indicates the high-order byte of the instruction address register.

With sense Format 6, byte 5 indicates the number of diskette checks after an initial microcode load (IML) or a storage director-to-storage director communication failure.

Bit 0	= Communication failure during an IML.
Bit 1	= Not used.
Bits 2-4	= Diskette check (seek errors).
Bits 5-7	= Diskette check (read errors).

## Sense Byte 6

If an alternate track condition is detected and byte 1, bit 7 (operation incomplete) is presented during an overflow operation, byte 6 is set in the head address of the defective track plus 1. The ERPs use this byte to build the seek argument to continue the operation. The remainder of the seek argument is obtained from the user, not the sense bytes.

With sense Format 3 (microcode detected), byte 6 indicates the low-order byte of the instruction address register.

With sense Format 6, byte 6 identifies the storage director.

In all other cases, sense byte 6 contains the following information.

### Bit 0

Bit 0 is not used. It is set to zero.

### Bit 1 - Cylinder-High Address

3330-1: Bit 1 identifies the high-order bit (256) of the cylinder address in sense byte 5.

3330-11: Bit 1 identifies the high-order bit (512) of the cylinder address in sense byte 5.

### Bit 2 - Difference

3330-1: Bit 2 is not used. It is set to zero.

3330-11: Bit 2 identifies the high-order bit (256) of the cylinder address in sense byte 5.

### Bits 3 through 7 - Head Address

Bits 3 through 7 identify the head address of the last seek (excluding retry seeks). The head address is updated during multitrack and overflow operations.

## **Sense Byte 7**

### **Bits 0 through 3 - Format**

Bits 0 through 3 specify the format of sense bytes 8 through 23 as follows:

- 0000 = Format 0 – Program or system checks.
- 0001 = Format 1 – Device equipment checks (CE information).
- 0010 = Format 2 – Storage director equipment checks (CE information).
- 0011 = Format 3 – Storage director control checks (CE information).
- 0100 = Format 4 – Data checks without displacement information.
- 0101 = Format 5 – Data checks with displacement information. (Format 5 may also be presented on errors which are not ECC correctable but which require restart displacement information.)
- 0110 = Format 6 – Usage statistics/overrun errors.

### **Bits 4 through 7 - Message**

Bits 4 through 7 describe the specific nature of the error conditions for each of the above formats. The message table that accompanies the format descriptions specifies the function of the message bits for the format.

## Format 0 – Program or System Check

Format 0 is used when sense bytes 0 through 7 completely describe the error or unusual condition caused by a program or system error.

### Bytes 8 through 20

Bytes 8 through 20 are not used. They are set to zero.

### Byte 21

Byte 21 contains the storage director ID.

### Bytes 22 and 23

Bytes 22 and 23 contain the symptom code.

## Message Table – Format 0

Sense Byte 7, Bits 4-7 =	Message Code	Message
0000	0	No message. No additional information is required.
0001	1	An invalid command was issued to the 3880.
0010	2	An invalid command sequence was issued to the 3880.
0011	3	The CCW count was less than required for the command.
0100	4	An invalid data argument was used for the command.
0101	5	A Diagnostic Write command was issued when not permitted by the file mask.
0110	6	Retry status was presented and the channel did not indicate chaining.
0111	7	The command code of the CCW returned after a retry sequence did not match the command for which the retry was signaled.
1000	8	A Diagnostic Load command was issued but the IML device was not ready.
1001	9	A Diagnostic Load command was issued but the IML device had a permanent seek check.
1010	A	A Diagnostic Load command was issued but the IML device had a permanent read check.
1011	B	The alternate track pointer of a defective track pointed to the defective track.
1100	C	Not used.
1101	D	The index point was detected in the gap of a record.
1110 and 1111	E,F	Not used.

## Format 1 – Device Equipment Check

Format 1 is generated when:

- A device, device interface, or a controller equipment check is detected. Byte 0, bit 3 (equipment check) is also set.
- A permanent device seek check is detected. Byte 0, bit 3 (equipment check) and byte 1, bit 0 (permanent error) are also set. The message bits in sense byte 7 indicate a seek error.
- Error log information is off-loaded after a successful retried seek that occurred during error logging. Byte 2, bit 3 (environmental data present) is also set. The message bits in sense byte 7 indicate a seek error.
- Byte 8, bit 4 (on line) is off. Byte 0, bit 1 (intervention required) is also set.

### Byte 8 - Module Status

Bit 0 = Index error	Bit 4 = On line
Bit 1 = Offset active	Bit 5 = Attention
Bit 2 = Seek incomplete	Bit 6 = Busy
Bit 3 = Seek complete	Bit 7 = Record ready

### Byte 9 - Monitor Mode

Bit 0 = Not used	Bits 5-7 identify the monitor modes as follows:
Bit 1 = Diagnostic state 4	001 = Mode 1 – rezero
Bit 2 = Diagnostic state 2	010 = Mode 2 – seek accelerate
Bit 3 = Diagnostic state 1	100 = Mode 4 – head load
Bit 4 = Not used	101 = Mode 5 – seek decelerate
	110 = Mode 6 – read
	111 = Mode 7 – write

### Byte 10 - Monitor State

These bits identify a monitor state that exists for each of the monitor modes described in sense byte 9.

Bit 0 = State 8	Bit 4 = State 4
Bit 1 = State 7	Bit 5 = State 3
Bit 2 = State 6	Bit 6 = State 2
Bit 3 = State 5	Bit 7 = State 1

### Byte 11 - Check Status

Bit 0 = CE program stop	Bit 4 = CTL-I bus out parity
Bit 1 = Not used	Bit 5 = Monitor check
Bit 2 = Not used	Bit 6 = Not used
Bit 3 = Not used	Bit 7 = Drive command reject

### Byte 12 - Safety

Bit 0 = Data safety	Bit 4 = Power on reset latched
Bit 1 = Servo safety	Bit 5 = Drive power on reset
Bit 2 = Not used	Bit 6 = Not heads loaded
Bit 3 = Pad safety (Model 11)	Bit 7 = Even latch

### Byte 13 - Device Bus Out

Byte 13 contains the actual device bus out (DBO) value for message code C. It is also set to the DBO value if the message code is 2 and byte 18, bits 4 through 7 are 1, 3, 5, 6, 9 or E. Byte 13 contains the expected device bus in (DBI) value for message codes 1, 3, 6, 7, 8, and 9. Otherwise, it is set to zero.

### Byte 14 - Device Bus In

Byte 14 contains the actual DBI value for message codes 1, 3, 6, 7, 8, 9, and C and for message code 2 if byte 18 equals X'01', X'03', X'05X', X'06', X'09', or X'0E'. Otherwise, it is set to zero.

### Byte 15 - Device Tag Gate

Byte 15 contains the device tag gate (DTG) register value for message codes 1, 3, 6, 7, 8, 9, and C and for message code 2 if byte 18 equals X'01', X'03', X'05', X'06', X'09', or X'0E'. Otherwise, it is set to zero.

### Byte 16 - Controller Check 1

Bit 0 = PLO error	Bit 4 = Write compensation check
Bit 1 = Write parity error	Bit 5 = Data transfer control check
Bit 2 = Read parity error	Bit 6 = Missing PLO pulses
Bit 3 = Bit ring error	Bit 7 = VFO phase error

### Byte 17 - Controller Check 2

Bit 0 = ECC no input data	Bit 4 = Sync-out check
Bit 1 = ECC PO or write	Bit 5 = PLO control check
Bit 2 = ECC P2 or P3	Bit 6 = Gap counter check
Bit 3 = ECC P1	Bit 7 = Gap control check



### Byte 18 - Controller Check 3

Bit 0 = Error alert.  
Bit 1 = Select active check.  
Bit 2 = Controller interface bus in check.  
Bit 3 = Not used.

Bits 4 through 7 indicate the following microcode detected errors:

0000 = No message.  
0001 = Device interface Tag Valid missing (read or write).  
0010 = Device interface Normal End and Check End missing.  
0011 = Device interface Normal End missing (control operation).  
0100 = Either no index for 40 milliseconds, or index always on.  
0101 = Unexpected status with Check End.  
0110 = 3330 selection check.  
0111 = Preselection check.  
1000 = Zero pattern alignment check.  
1001 = Repetitive command overruns.  
1010 = Drive interrupt during busy.  
1011 = Drive status not as expected after a seek or Set Sector command.  
1100-1110 = Not used.  
1111 = Always active bus in bit.

### Byte 19 - Controller Check 4

Bit 0 = Drive selection error      Bit 4 = Write sense check  
Bit 1 = CTL-I tag bus check      Bit 5 = Read/write valid check  
Bit 2 = Device check              Bit 6 = DBO register check  
Bit 3 = CTL-I bus out check      Bit 7 = Controller bus in assembler check

### Bytes 20 and 21

Bytes 20 and 21 are not used.

### Bytes 22 and 23

Bytes 22 and 23 contain the symptom code.

## Message Table – Format 1

Sense Byte 7, Bits 4-7 =	Message Code	Message
0000	0	No message. No additional information is required.
0001	1	Set target error.
0010	2	Microcode detected error.
0011	3	Not used.
0100	4	Not used.
0101	5	String switch primed interrupt error.
0110	6	Transmit cylinder error.
0111	7	Transmit head error.
1000	8	Transmit difference error.
1001	9	Drive status not as expected during execution of a Read IPL or during retry that required the reset of the offset active or set sector bits.
1010	A	Seek error.
1011	B	Seek incomplete on retry.
1100	C	No interrupt from drive.
1101	D	ECC P2 or P3 compare failure.
1110	E	ECC P1 compare failure.
1111	F	Retry PLO counter or sector value incorrect.

## Format 2 – Storage Director Equipment Check

Format 2 is generated to provide sense information when the microcode detects a storage director error condition.

<b>Byte 8</b>	Contents of the transfer complete status (XCS) register.
<b>Byte 9</b>	Contents of the transfer error status (XES) register.
<b>Byte 10</b>	Contents of the check (CHK) register.
<b>Byte 11</b>	Contents of the channel transfer complete (CXC) register.
<b>Byte 12</b>	Contents of channel control 2 (CC2) register.
<b>Byte 13</b>	Contents of the device bus out (DBO) register.
<b>Byte 14</b>	Contents of the device bus in (BDI) register.
<b>Byte 15</b>	Contents of the device tag out (DTO) register.
<b>Byte 16</b>	Contents of the device tag gate (DTG) register.
<b>Byte 17</b>	Contents of the device tag in (DTI) register.
<b>Byte 18</b>	Contents of channel status 2 (CS2) register.
<b>Byte 19</b>	Not used.
<b>Byte 20</b>	Byte 20 indicates microcode-detected check 2 conditions.  Bits 0 through 3 are not used. If bits 4 through 7 equal 0001, the device attempted to end data transfer prematurely.
<b>Byte 21</b>	Storage director ID.
<b>Bytes 22 and 23</b>	Symptom code.

## Message Table – Format 2

<b>Sense Byte 7, Bits 4-7 =</b>	<b>Message Code</b>	<b>Message</b>
0000-0111	0-7	Reserved for other types of storage control units.
1000	8	No message. No additional information required.
1001	9	Selective reset occurred while the drive was selected.
1010	A	Failed to latch the First Sync-In line.
1011	B	Reserved.
1100	C	Channel failed to respond to a selective reset request.
1101 and 1110	D and E	Reserved.
1111	F	Microcode detected check. The message appears in byte 20, bits 4 through 7.

## Format 3 – Storage Director Control Check (Hardware Detected)

Format 3 is generated to provide sense information for a failing storage director that requires a reset procedure for recovery.

<b>Byte 8</b>	Contents of the field-replaceable unit (FRU) register 2 (bit 4 = 0).
<b>Byte 9</b>	Contents of check register 1.
<b>Byte 10</b>	Contents of check register 2.
<b>Byte 11</b>	Contents of check register 3.
<b>Byte 12</b>	Not used.
<b>Byte 13</b>	Not used.
<b>Byte 14</b>	Not used.
<b>Byte 15</b>	Contents of FRU register 3.
<b>Byte 16</b>	Contents of FRU register 4.
<b>Byte 17</b>	Not used.
<b>Byte 18</b>	Not used.
<b>Byte 19</b>	Not used.
<b>Byte 20</b>	Not used.
<b>Byte 21</b>	Storage director ID.
<b>Bytes 22 and 23</b>	Symptom code.

## Message Table – Format 3

<b>Sense Byte 7, Message Bits 4-7 =</b>	<b>Message Code</b>	<b>Message</b>
0000-0111	0-7	Reserved for other types of storage control units.
1000	8	No message. No additional information required.
1001-1111	9-F	Reserved.

### Format 3 – Storage Director Control Check (Microcode Detected)

<b>Byte 8</b>	Not used.
<b>Byte 9</b>	Contents of the transfer error status (XES) register.
<b>Byte 10</b>	Contents of the check register.
<b>Byte 11</b>	Contents of the condition register 0 (CR0).
<b>Byte 12</b>	Contents of the channel status 2 (CS2) register.
<b>Byte 13</b>	Contents of the channel control 1 (CC1) register.
<b>Byte 14</b>	Contents of the channel control 2 (CC2) register.
<b>Byte 15</b>	Contents of the channel status 1 (CS1) register.
<b>Byte 16</b>	Contents of the channel status 3 (CS3) register.
<b>Byte 17</b>	Contents of the channel transfer control (CXC) register.
<b>Byte 18</b>	Contents of the channel bus out (CB0) register.
<b>Byte 19</b>	Contents of the channel bus in (CBI) register.
<b>Byte 20</b>	When sense bytes 22 and 23 contain a symptom code of 3F2X, this byte contains the timeout message. Otherwise, this byte is the interrupt level.
<b>Byte 21</b>	Storage director ID.
<b>Bytes 22 and 23</b>	Symptom code.

### Message Table – Format 3

<b>Sense Byte 7, Bits 4-7 =</b>	<b>Message Code</b>	<b>Message</b>
0000-0111	0-7	Reserved.
1000	8	No message (3880 control check).
1001	9	Channel check 1 or storage director timeout.
1010	A	Trace table saved in this storage director.
1011-1111	B-F	Reserved.

## **Format 4 – Data Check Without Displacement Information**

Format 4 is generated when:

- Errors that were not correctable by the ECC are detected after retry has been unsuccessful. Byte 1, bit 0 (permanent error) is also set.
- Error log information is off-loaded after an ECC uncorrectable error occurred during error logging. The information was recovered through use of command retry. Byte 2, bit 3 (environmental data present) is also set.
- Data checks are detected while processing a Read Multiple CKD command.

### **Bytes 8 through 12 - Count ID**

Bytes 8 through 12 contain the record ID obtained from the count field of the record in which the error occurred. These bytes are unreliable if the message code in byte 7 is 0, 1, 4, 5, or 9. Byte 12 is zero if the message code is 0 or 4.

### **Byte 13 - Sector Number**

Byte 13 contains the sector number of the record in error.

### **Byte 14 - Access Offset**

For permanent errors, this byte contains the head offset last used for retrying a data check. If the error was not permanent, this byte provides the offset required to recover from the error.

### **Byte 15 - Retry Count**

Byte 15 contains the number of retries required to process the error condition.

### **Byte 16 - Source Drive ID**

Byte 16 identifies the physical controller and drive that recorded the data in which the error occurred. (See Sense Byte 4.)

### **Bytes 17 through 21**

Bytes 17 through 21 are not used.

### **Bytes 22 and 23**

Bytes 22 and 23 contain the symptom code.

## Message Table – Format 4

<b>Sense Byte 7, Bits 4-7 =</b>	<b>Message Code</b>	<b>Message</b>
0000	0	An error occurred in the home address area and could not be corrected by the ECC.
0001	1	An error occurred in the count area and could not be corrected by the ECC.
0010	2	An error occurred in the key area and could not be corrected by the ECC.
0011	3	An error occurred in the data area and could not be corrected by the ECC.
0100	4	Data synchronization on the home address area was unsuccessful.
0101	5	Data synchronization on the count area was unsuccessful.
0110	6	Data synchronization on the key area was unsuccessful.
0111	7	Data synchronization on the data area as unsuccessful.
1000	8	Not used.
1001	9	Address mark reorientation was unsuccessful on retry.
1010-1111	A-F	Not used.



## **Format 5 – Data Check With Displacement Information**

Format 5 is generated when:

- Data checks that are correctable by the ECC are detected in the data areas of a record.
- Data checks in data areas that are not correctable by the ECC were successfully retried but the file mask specified PCI fetch mode.
- Error log information is off-loaded after an ECC correctable error occurred during error logging.
- Data checks are detected while processing a second or subsequent segment of an overflow record.

### **Bytes 8 through 12 - Count ID**

Bytes 8 through 12 contain the record ID obtained from the count field of the record in which the error occurred. These bytes are unreliable if the message code in byte 7 is 0, 1, 4, or 5. Byte 12 is unreliable after a Space Count command.

### **Byte 13 - Sector Number**

Byte 13 contains the sector number of the record in error.

### **Byte 14 - Access Offset**

For permanent errors, this byte contains the head offset last used for retrying a data check. If the error was not permanent, this byte provides the offset required to recover from the error.

### **Bytes 15 through 17**

Bytes 15 through 17 contain the restart displacement.

### **Bytes 18 and 19**

Bytes 18 and 19 contain the error displacement.

### **Bytes 20 through 22**

Bytes 20 through 22 contain the error pattern.

### **Byte 23**

Bits 0 through 6 are not used. Bit 7 indicates that the channel truncated data transfer.

## Message Table – Format 5

<b>Sense Byte 7, Bits 4-7 =</b>	<b>Message Code</b>	<b>Message</b>
0000	0	Home address data check.
0001	1	Count area data check.
0010	2	Key area data check.
0011	3	Data area data check.
0100-1111	4-F	Not used.

## **Format 6 – Usage Statistics/Overrun Errors**

Format 6 is generated when:

- A Read and Reset Buffered Log command is executed.
- Usage/error statistics require off-loading because of counter overflow.

### **Bytes 8 through 11 - Bytes Read or Searched**

Bytes 8 through 11 contain an accumulated count of the number of bytes processed by the storage director during read and search operations. (Only key and data area bytes are counted.) Bytes processed during retry operations are not counted.

### **Bytes 12 and 13 - Correctable Data Checks**

Bytes 12 and 13 contain the accumulated count of the number of ECC correctable data checks which were detected by the storage director.

### **Bytes 14 and 15 - Uncorrectable Data Checks Retried**

Bytes 14 and 15 contain the number of ECC uncorrectable data checks retried by the storage director.

### **Bytes 16 and 17 - Number of Seeks**

Bytes 16 and 17 contain the number of access moves processed by the storage director.

### **Byte 18 - Channel Select**

Byte 18 specifies which channels the information in bytes 20 through 23 pertain to if bits 0 and 1 are:

00 = channels A and B	01 = channels E and F
10 = channels C and D	11 = channels G and H

Bits 2 through 7 are not used.

### **Byte 19 - Seek Errors**

Byte 19 contains the number of seek errors retried by the storage director.

### **Byte 20 - Command Overruns - Channel A, C, E, or G**

Byte 20 indicates that a command overrun occurred on the channel specified by byte 18, bits 0 and 1.

00 = channel A	01 = channel E
10 = channel C	11 = channel G

### Byte 21 - Data Overruns - Channel A, C, E, or G

Byte 21 indicates that a data overrun occurred on the channel specified by byte 18, bits 0 and 1.

00 = channel A	01 = channel E
10 = channel C	11 = channel G

### Byte 22 - Command Overruns - Channel B, D, F, or H

Byte 22 indicates that a command overrun occurred on the channel specified by byte 18, bits 0 and 1.

00 = channel B	01 = channel F
10 = channel D	11 = channel H

### Byte 23 - Data Overruns - Channel B, D, F, or H

Byte 23 indicates that a data overrun occurred on the channel specified by byte 18, bits 0 and 1.

00 = channel B	01 = channel F
10 = channel D	11 = channel H

### Message Table – Format 6

Sense Byte 7, Bits 4-7 =	Message Code	Message
0000-0111	0-7	Not used.
1000	8	3880 offload.
1001-1111	9-F	Not used.

### Error Condition Table – 3330

The 3330 error condition table is combined with the 3350 error condition table. See Error Condition Table – 3330 and 3350.

### Recovery Action Table – 3330

The 3330 recovery action table is combined with the 3350 recovery action table. See Recovery Action Table – 3330 and 3350.

## Chapter 9. Sense Bytes – 3350

Sense information for the 3350 (24 bytes) identifies the conditions that caused the last unit check status to be generated. The sense information also provides secondary information for system error recovery and for diagnosing and isolating storage control and device malfunctions.

### Sense Byte 0

#### Bit 0 - Command Reject

Bit 0 is set by:

- An invalid command code
- An invalid command sequence
- An invalid or incomplete argument transferred by a control command
- A track formatted without a home address
- Issuing a Write command with the Write Inhibit switch in the Read-Only position
- Attempting a format write command (other than Write Home Address or Write R0) on a defective track
- Issuing a write command that violates the file mask
- A record zero count field of a defective track that points to itself instead of to the alternate track.

#### Bit 1 - Intervention Required

Bit 1 is set by:

- Addressing a drive that is not attached to the system
- Addressing a drive that is not ready
- Issuing a Diagnostic Write or Diagnostic Load command while an inline diagnostic is resident in control storage
- Addressing a drive that is in CE mode and not available.

### **Bit 2 - Bus Out Parity**

Bit 2 is set when a parity error is detected during transfer of a command or data from the channel to the 3880.

### **Bit 3 - Equipment Check**

Bit 3 is set when an unusual hardware condition occurs in the channel, storage director, controller, or drive. The condition is further defined in sense bytes 7 through 23.

### **Bit 4 - Data Check**

Bit 4 is set when the storage director detects a data error in the information received from the drive. If byte 2, bit 1 (correctable) is also set, the data error is correctable and bytes 15 through 23 in Format 5 provide correction information. If the data error is uncorrectable, sense byte 7 defines the specific nature of the condition.

### **Bit 5 - Overrun**

Bit 5 is set when the storage director does not receive a response to a data request within a specified period of time.

Detection of an overrun may cause requests for data from the channel to be terminated. When writing, the remaining portion of the record area is padded with a replicated data byte.

All data overrun conditions are retried by the storage director except those that occur in the second or subsequent sections of an overflow record, or those that occur during a format write operation, or those that occur during a Read Multiple Count Key, and Data command.

The storage director presents an overrun only if the condition occurs more than ten times during a CCW chain, or if the overrun occurs during one of the above operations not retried by the storage director.

Command overruns are also retried by the storage director and do not cause an overrun to be presented.

### **Bit 6**

Bit 6 is not used. It is set to zero.

### **Bit 7**

Bit 7 is not used. It is set to zero.

## Sense Byte 1

### Bit 0 - Permanent Error

Bit 0 is set when internal error recovery has been exhausted (through use of command retry) and was unsuccessful, or when internal error recovery was not possible or desirable.

The bit overrides any other bit settings and indicates that system error recovery procedures may not be required.

### Bit 1 - Invalid Track Format

Bit 1 is set when:

- An attempt is made to write data exceeding track capacity
- An index point is detected in the gap that precedes a key or data field.
- A previous operation attempted to write data exceeding the track capacity; this operation resulted in a record written into index. This record was encountered while attempting to execute a read, search, or write command. As long as this record remains on the track, invalid track format may be presented while attempting to locate a record successfully written on the track. However, a Search ID will be able to execute on any count field successfully written on the track without presenting invalid track format.

### Bit 2 - End of Cylinder

Bit 2 is set when:

- A multitrack read or search operation continues past the end of the cylinder boundary
- An overflow operation continues past the end of the cylinder boundary. Byte 1, bit 7 (operation incomplete) is also set.

### Bit 3 - Message to Operator

Bit 3 is set when there is a permanent failure in the alternate storage director or a state save operation in the reporting storage director. Byte 0, bit 3 (equipment check) is also set. A message is sent to the operator. This bit is used for Format 3 only.

### Bit 4 - No Record Found

Bit 4 is set when two index points have been detected in the same CCW chain without an intervening read operation in the home address area or data area, or without an intervening write, sense, or control command.

### **Bit 5 - File Protected**

Bit 5 is set when:

- A seek command violates the file mask
- A multitrack read or search operation violates the file mask
- An overflow operation violates the seek portion of the file mask. Byte 1, bit 7 (operation incomplete) is also set.

### **Bit 6 - Write Inhibited**

Bit 6 is set when a write command is received for a drive that has its Write Inhibit switch in the Read-Only position. The Diagnostic Control command has inhibited write operations on this data path. Byte 0, bit 3 (Equipment Check) and byte 0, bit 0 (command reject) are also set.

### **Bit 7 - Operation Incomplete**

Bit 7 is set when one of the following conditions occurs during the processing of an overflow record.

- An overflow to a file protected boundary occurs. Byte 1, bit 5 (file protected) is also set.
- An overflow past the cylinder boundary occurs. Byte 1, bit 2 (end of cylinder) is also set.
- A correctable data check is detected in a data field other than the last segment. Byte 0, bit 4 (data check) and byte 2, bit 1 (correctable) are also set.
- An uncorrectable data check is detected in any field of any segment other than the first segment
- A defective or alternate track condition is detected after the start of data transfer
- A seek error is detected in the second or subsequent segment.

Sense byte 3 provides the restart command, and sense bytes 8 through 13 provide restart information.



## **Sense Byte 2**

### **Bit 0**

Bit 0 is not used. It is set to zero.

### **Bit 1 - Correctable**

Bit 1 is set when the data check condition indicated by byte 0, bit 4 (data check) is correctable.

### **Bit 2 - Alternate Controller Selected**

Bit 2 is set when the controller in the Model C2 is selected.

### **Bit 3 - Environmental Data Present**

Bit 3 is set to indicate that bytes 8 through 23 contain usage or error statistics, or error log information. Byte 7 indicates the format for bytes 8 through 23.

### **Bits 4 and 5**

Bits 4 and 5 are not used. They are set to zero.

### **Bit 6 - Write Operation**

Bit 6 is set to indicate that an error occurred during execution of a write operation.

### **Bit 7**

Bit 7 is not used. It is set to zero.

## **Sense Byte 3**

### **Bits 0 through 7 - Restart Command**

Bits 0 through 7 are set when byte 1, bit 7 (operation incomplete) is set. These bits identify the type of operation that was in progress when the interrupt occurred. If the bits are set to 0000 0110, a read operation was in progress; if they are set to 0000 0101, a write operation was in progress.

## Sense Byte 4

### Bits 0 through 7 - Drive Identification

Bits 0 through 7 identify the drive associated with the sense information.

Bit 0 = Drive 0	Bit 4 = Drive 4
Bit 1 = Drive 1	Bit 5 = Drive 5
Bit 2 = Drive 2	Bit 6 = Drive 6
Bit 3 = Drive 3	Bit 7 = Drive 7

## Sense Byte 5

### Bits 0 through 7 - Cylinder-Low Address

Bits 0 through 7 identify the low-order cylinder address of the most recent seek argument from the channel.

Bit 0 = Cylinder 128	Bit 4 = Cylinder 8
Bit 1 = Cylinder 64	Bit 5 = Cylinder 4
Bit 2 = Cylinder 32	Bit 6 = Cylinder 2
Bit 3 = Cylinder 16	Bit 7 = Cylinder 1

With sense Format 3 (microcode detected), byte 5 contains the high-order byte of the instruction address register.

With sense Format 6, byte 5 indicates the number of diskette checks after an initial microcode load (IML) or a storage director-to-storage director communication failure.

Bit 0 = Communication failure during an IML	Bits 2-4 = Diskette check (seek errors)
Bit 1 = Not used	Bits 5-7 = Diskette check (read errors)

## Sense Byte 6

### Bits 0 through 7 - Cylinder-High and Head Address

Bits 0 through 7 identify the high-order cylinder and head address of the most recent seek argument from the channel. When the CE cylinder 1024 (byte 6, bit 0 = 1) is addressed, all other cylinder bits in bytes 5 and 6 are zero.

Bit 0 = CE cylinder 1024	Bit 4 = Logical head 8
Bit 1 = Cylinder 512	Bit 5 = Logical head 4
Bit 2 = Cylinder 256	Bit 6 = Logical head 2
Bit 3 = Logical head 16	Bit 7 = Logical head 1

Operations involving head switching update the head address bits (4 through 7) of this byte.

If an alternate track condition is detected and byte 1, bit 7 (operation incomplete) is presented during an overflow operation, byte 6 is set to the head address of the defective track and incremented by 1. The error recovery procedures use this byte to rebuild the seek argument used to continue the operation.

With sense Format 3 (microcode detected), byte 6 indicates the low-order byte of the instruction address register.

With sense Format 6, byte 6 identifies the storage director.

## Sense Byte 7

### Bits 0 through 3 - Format

Bits 0 through 3 specify the format of sense bytes 8 through 23 as follows:

- 0000 = Format 0 – Program or system check.
- 0001 = Format 1 – Device equipment check (CE information).
- 0010 = Format 2 – Storage director equipment check (CE information).
- 0011 = Format 3 – Storage director control check (CE information).
- 0100 = Format 4 – Data check without displacement information.
- 0101 = Format 5 – Data check with displacement information. (Format 5 may also be presented on errors which are not ECC correctable but which require restart displacement information.)
- 0110 = Format 6 – Usage statistics/overrun errors.

### Bits 4 through 7 - Message

Bits 4 through 7 describe the specific nature of the error conditions for each of the above formats. The message table that accompanies the format descriptions specifies the function of the message bits for the format.

## Format 0 – Program or System Check

Format 0 is used when sense bytes 0 through 7 completely describe the error or unusual condition caused by a program or system error.

### Bytes 8 through 17

Bytes 8 through 17 are not used. They are set to zero.

### Bytes 18 through 23 - Skip Displacement

If a Sense command is chained from a successful Read Home Address command and no contingent connection exists, bytes 18 through 23 contain the skip displacement bytes of the track.

If a Sense command is not chained from a Read Home Address and a contingent connection exists, byte 21 contains the storage director ID and bytes 22 and 23 contain the symptom code. Otherwise, bytes 18 through 23 are set to zero.

## Message Table – Format 0

Sense Byte 7, Message Bits 4-7 = Code		Message
10000	0	No message. No additional information required.
0001	1	An invalid command was issued to the 3880.
0010	2	An invalid command sequence was issued to the 3880.
0011	3	The CCW count was less than required for the command.
0100	4	An invalid data argument was used for the command.
0101	5	A Diagnostic Write command was issued when not permitted by the file mask.
0110	6	Retry status was presented and the channel did not indicate chaining.
0111	7	The command code of the CCW that was returned after a retry sequence did not match the command for which the retry was signaled.
1000	8	A Diagnostic Load command was issued but the IML device is not ready.
1001	9	A Diagnostic Load command was issued but the IML device had a permanent seek check.
1010	A	A Diagnostic Load command was issued but the IML device had a permanent read check.
1011	B	The alternate track pointer of a defective track pointed to the defective track.
1100	C	Unconditionally reserved.
1101-1111	D-F	Not used.

## Format 1 – Device Equipment Check

Format 1 is generated when:

- A device, device interface, or a controller equipment check is detected. Byte 0, bit 3 (equipment check) is also set.
- A permanent device seek check is detected. Byte 0, bit 3 (equipment check) and byte 1, bit 0 (permanent error) are also set. The message bits in sense byte 7 indicate a seek error.
- Error log information is off-loaded after a successful retried seek because of a seek check that occurred during error logging. Byte 3, bit 2 (environmental data present) is also set. The message bits in sense byte 7 indicate a seek error.
- Byte 8, bit 4 (on line) is off. Byte 0, bit 1 (intervention required) is also set.

### Byte 8 - Drive Status

When byte 19, bit 0 (set R/W) is off:

Bit 0 = Controller check	Bit 5 = HDA attention
Bit 1 = Device interface check	Bit 6 = Busy
Bit 2 = Drive check	Bit 7 = Seek complete, search sector, or pad complete. If bit 6 is on, search sector is in progress.
Bit 3 = R/W check	
Bit 4 = On line	

When byte 19, bit 0 is on:

Bit 0 = Controller check	Bit 4 = On line
Bit 1 = 1 (current) write sense	Bit 5 = Pad in progress
Bit 2 = Drive check	Bit 6 = Index mark
Bit 3 = R/W check	Bit 7 = 3330 modes

### Byte 9 - Drive Checks

Bit 0 = Pad in progress	Bit 4 = Write enable
Bit 1 = Sector compare check	Bit 5 = FH HDA installed
Bit 2 = Motor-at-speed switch latched	Bit 6 = Spindle mode 2
Bit 3 = Air switch latched	Bit 7 = Spindle mode 1

### Byte 10 - Sequence Control

Bit 0 = Mode size check	Bit 4 = Timer latch
Bit 1 = HDA sequence latch 4	Bit 5 = HDA sequence check latched
Bit 2 = HDA sequence latch 2	Bit 6 = Not used
Bit 3 = HDA sequence latch 1	Bit 7 = Odd physical track

### Byte 11 - Load Switch Status

Bit 0 = Drive start switch	Bit 4 = Not used
Bit 1 = Guardband pattern	Bit 5 = Air switch
Bit 2 = Target velocity	Bit 6 = Not used
Bit 3 = Track crossing	Bit 7 = Motor-at-speed switch

### Byte 12 - R/W Safety

Bit 0 = Multiple-head select check	Bit 4 = Delta current check
Bit 1 = Capable/enable check	Bit 5 = Control check
Bit 2 = Write overrun	Bit 6 = Write transition check
Bit 3 = Index check	Bit 7 = Write current during read check

### Byte 13 - Control Interface Check

Byte 13 contains the actual DBO value for message code C and for message code 2, if byte 18 equals X'01', X'03', X'05', X'06', X'09', or X'0E'. Byte 13 contains the expected DBI value for messages, 1, 3, 5, 6, 7, 8, and 9.

If bits 4 through 7 of byte 7 equal 1010, or if they equal 1011 and bit 1 of byte 9 equals 0, byte 13 contains the low physical cylinder address of the previous seek.

Bit 0 = 128	Bit 4 = 8
Bit 1 = 64	Bit 5 = 4
Bit 2 = 32	Bit 6 = 2
Bit 3 = 16	Bit 7 = 1

Otherwise, byte 13 is set to zero.

### Byte 14 - Control Interface Bus In

Byte 14 contains the actual DBI value for messages 1, 3, 5, 6, 7, 8, 9, and C and for message 2 if byte 18 equals X'01', X'03', X'05', X'06', X'09', or X'0E'.

If bits 4 through 7 of byte 7 equal 1010, or if they equal 1011 and bit 1 of byte 9 equals 0, byte 14 contains the high physical cylinder address and physical head address of the previous seek.

Bit 0 = 512	Bit 4 = 8
Bit 1 = 256	Bit 5 = 4
Bit 2 = 32	Bit 6 = 2
Bit 3 = 16	Bit 7 = 1

Otherwise, byte 14 is set to zero.

### Byte 15 - Control Interface Tag Bus

Byte 15 contains the actual DTO value for message codes 1, 3, 5, 6, 7, 8, 9, and C, and message code 2 if byte 18 equals X'012', X'032', X'05', X'06', X'09', or X'0E'.

Otherwise, byte 15 is set to zero.

### Byte 16 - Access Status

Bit 0 = Access time-out check	Bit 4 = Servo latch
Bit 1 = Overshoot check	Bit 5 = Linear mode latch
Bit 2 = Servo off-track check	Bit 6 = Control latch
Bit 3 = Rezero mode latch	Bit 7 = Wait latch

### Byte 17 - Controller Check

Bit 0 = VFO detected error, 2 bit	Bit 4 = Write data check
Bit 1 = VFO detected error, 1 bit	Bit 5 = Monitor check
Bit 2 = SERDES check	Bit 6 = ECC check
Bit 3 = Gap counter check	Bit 7 = ECC zero detected

### Byte 18 - Microcode Detected Errors

Bits 0 through 3 are not used. Bits 4 through 7 indicate the following error conditions:

0000 = Not used.  
0001 = Tag Valid indication missing on a read or write operation.  
0010 = Normal End or Check End indication missing on a read, write, or ECC operation.  
0011 = No response from the controller on a control operation.  
0100 = A time out occurred while waiting for index.  
0101 = ECC hardware check.  
0110 = Either more than one controller was selected or no controller was selected.  
0111 = Preselection check.  
1000 = Repetitive command overruns on gap 1 operations.  
1001 = Repetitive command overruns.  
1010 = Incorrect drive selected.  
1011 = Busy missing after seek start was issued.  
1100 = Not used.  
1101 = Not used.  
1110 = Always active bus in bit.  
1111 = Interrupt cannot be reset.



## Byte 19 - Status

Bit 0 = Set R/W on	Bit 4 = Head short check
Bit 1 = Reserved	Bit 5 = Pad gate check
Bit 2 = Reserved	Bit 6 = 1.2 megabyte controller
Bit 3 = Reserved	Bit 7 = Always on

## Byte 20 - Interface Checks

When byte 7, bits 4 through 7 are not equal to 1010, or when they equal 1010 and byte 8, bit 2 is on, the bits in byte 20 have the following meaning:

Bit 0 = Control interface tag bus parity check	Bit 4 = Control interface bus in parity check
Bit 1 = Control interface bus out parity check	Bit 5 = I (ampere) write failure parity check
Bit 2 = Drive selection check	Bit 6 = Not used
Bit 3 = Device bus in parity check	Bit 7 = Reorient counter check

When byte 8, bit 2 is zero and message A is indicated in sense byte 7, byte 20 contains the present seek address and low physical cylinder address.

Bit 0 = Cylinder 128	Bit 4 = Cylinder 8
Bit 1 = Cylinder 64	Bit 5 = Cylinder 4
Bit 2 = Cylinder 32	Bit 6 = Cylinder 2
Bit 3 = Cylinder 16	Bit 7 = Cylinder 1

## Byte 21 - Device Interface Check

When byte 7, bits 4 through 7 are not equal to 1010, or when they equal 1010 and byte 8, bit 2 is on, byte 21 contains device interface check information.

Bit 0 = Not used	Bit 4 = Not used
Bit 1 = Not used	Bit 5 = Not used
Bit 2 = Not used	Bit 6 = Device bus out parity check
Bit 3 = Not used	Bit 7 = Device tag parity check

When byte 8, bit 2 is zero and message A is indicated in sense byte 7, byte 21 contains the high physical cylinder and physical head address of the present seek.

Bit 0 = Cylinder 512	Bit 4 = Head 8
Bit 1 = Cylinder 256	Bit 5 = Head 4
Bit 2 = Head 32	Bit 6 = Head 2
Bit 3 = Head 16	Bit 7 = Head 1

## Bytes 22 and 23

Bytes 22 and 23 contain the symptom code.

### Sense Byte 7, Message

Bits 4-7 =	Code	Message
0000	0	No message. No additional information required.
0001	1	Transmit target error.
0010	2	Microcode detected error.
0011	3	Transmit difference-high error.
0100	4	Sync-out timing error.
0101	5	Unexpected drive status at initial selection.
0110	6	Transmit cylinder address error.
0111	7	Transmit head error.
1000	8	Transmit difference error.
1001	9	Unexpected drive status.
1010	A	Seek error.
1011	B	Seek incomplete on retry or sector non-compare.
1100	C	No interrupt from drive.
1101	D	Defect skipping - re-orientation check.
1110	E	Unable to determine device type during initial selection.
1111	F	Retry orientation check.

## Format 2 – Storage Director Equipment Check

Format 2 is generated to provide sense information when the microcode detects a storage director error condition.

<b>Byte 8</b>	Contents of the transfer complete status (XCS) register.
<b>Byte 9</b>	Contents of the transfer error status (XES) register.
<b>Byte 10</b>	Contents of the check (CHK) register.
<b>Byte 11</b>	Contents of the channel transfer complete (CXC) register.
<b>Byte 12</b>	Contents of channel control 2 (CC2) register.
<b>Byte 13</b>	Contents of the device bus out (DBO) register.
<b>Byte 14</b>	Contents of the device bus in (BDI) register.
<b>Byte 15</b>	Contents of the device tag out (DTO) register.
<b>Byte 16</b>	Contents of the device tag gate (DTG) register.
<b>Byte 17</b>	Contents of the device tag in (DTI) register.
<b>Byte 18</b>	Contents of channel status 2 (CS2) register.
<b>Byte 19</b>	Not used.
<b>Byte 20</b>	Byte 20 indicates microcode-detected checks.  Bits 0 through 3 are not used. If bits 4 through 7 equal 0001, the device attempted to end data transfer prematurely. If bits 4 through 7 equal 0010, selection was lost at the time a device error was detected.
<b>Byte 21</b>	Storage director ID.
<b>Bytes 22 and 23</b>	Symptom code.

## Message Table – Format 2

<b>Sense Byte 7, Bits 4-7 =</b>	<b>Message Code</b>	<b>Message</b>
0000-0111	0-7	Reserved for other types of storage control units.
1000	8	No message. No additional information required.
1001	9	Selective reset occurred while the drive was selected.
1010	A	Failed to latch the First Sync-In line.
1011	B	The Diagnostic Control command has inhibited write operations on this data path.
1100	C	Channel failed to respond to a selective reset request.
1101 and 1110	D and E	Reserved.
1111	F	Microcode detected check. The message appears in byte 20, bits 4 through 7.

## Format 3 – Storage Director Control Check (Hardware Detected)

This Format 3 is generated to provide sense information for a failing storage director that requires a reset procedure for recovery.

<b>Byte 8</b>	Contents of FRU register 2 (bit 4 = 0).
<b>Byte 9</b>	Contents of Check register 1.
<b>Byte 10</b>	Contents of Check register 2.
<b>Byte 11</b>	Contents of Check register 3.
<b>Byte 12</b>	Not used.
<b>Byte 13</b>	Not used.
<b>Byte 14</b>	Not used.
<b>Byte 15</b>	Contents of FRU register 3.
<b>Byte 16</b>	Contents of FRU register 4.
<b>Byte 17</b>	Not used.
<b>Byte 18</b>	Not used.
<b>Byte 19</b>	Not used.
<b>Byte 20</b>	Not used.
<b>Byte 21</b>	Storage director ID.
<b>Bytes 22 and 23</b>	Symptom code.

### Message Table – Format 3

<b>Sense Byte 7, Message</b>		
<b>Bits 4-7 =</b>	<b>Code</b>	<b>Message</b>
0000-0111	0-7	Reserved for other types of storage control units.
1000	8	No message. No additional information required
1001-1111	9-F	Reserved.

### Format 3 – Storage Director Control Check (Microcode Detected)

<b>Byte 8</b>	Not used.
<b>Byte 9</b>	Contents of the transfer error status (XES) register.
<b>Byte 10</b>	Contents of the check register.
<b>Byte 11</b>	Contents of the condition register 0 (CR0).
<b>Byte 12</b>	Contents of the channel status 2 (CS2) register.
<b>Byte 13</b>	Contents of the channel control 1 (CC1) register.
<b>Byte 14</b>	Contents of the channel control 2 (CC2) register.
<b>Byte 15</b>	Contents of the channel status 1 (CS1) register.
<b>Byte 16</b>	Contents of the channel status 3 (CS3) register.
<b>Byte 17</b>	Contents of the channel transfer control (CXC) register.
<b>Byte 18</b>	Contents of the channel bus out (CBO) register.
<b>Byte 19</b>	Contents of the channel bus in (CBI) register.
<b>Byte 20</b>	Contains the timeout message when sense bytes 22 and 23 contain a symptom code of 3F2X. Otherwise, this byte is the interrupt level.
<b>Byte 21</b>	Storage director ID.
<b>Bytes 22 and 23</b>	Symptom code.

### Message Table – Format 3

<b>Sense Byte 7, Bits 4-7 =</b>	<b>Message Code</b>	<b>Message</b>
0000-0111	0-7	Reserved.
1000	8	No message (3880 control check).
1001	9	Channel check 1 or storage director timeout.
1010	A	Trace table saved in this storage director.
1011-1111	B-F	Reserved.

## **Format 4 – Data Check Without Displacement Information**

Format 4 is generated when:

- Errors that are not correctable by the ECC are detected after retry has been unsuccessful. Byte 1, bit 0 (permanent error) is also set.
- Error log information is off-loaded after an ECC uncorrectable error occurred during error logging. The information was recovered through use of command retry. Byte 2, bit 3 (environmental data present) is also set.
- Data checks are detected while processing a Read Multiple CKD command.

### **Bytes 8 through 12 - Count ID**

Bytes 8 through 12 contain the record ID obtained from the count field of the record in which the error occurred. These bytes are unreliable if the message code in byte 7 is 0, 1, 4, 5, or 9. Byte 12 is zero if the message code is 0 or 4.

### **Byte 13 - Sector Number**

Byte 13 contains the sector number of the record in error.

### **Bytes 14 through 21**

Bytes 14 through 21 are not used.

### **Bytes 22 and 23**

Bytes 22 and 23 contain the symptom code.

## Message Table – Format 4

<b>Sense Byte 7, Message Bits 4-7 =</b>	<b>Code</b>	<b>Message</b>
0000	0	An error occurred in the home address area and could not be corrected by the ECC.
0001	1	An error occurred in the count area and could not be corrected by the ECC.
0010	2	An error occurred in the key area and could not be corrected by the ECC.
0011	3	An error occurred in the data area and could not be corrected by the ECC.
0100	4	Data synchronization on the home address area was unsuccessful.
0101	5	Data synchronization on the count area was unsuccessful.
0110	6	Data synchronization on the key area was unsuccessful.
0111	7	Data synchronization on the data area was unsuccessful.
1000	8	Not used.
1001	9	No address mark was detected upon retry.
1010-1111	A-F	Not used.



## **Format 5 – Data Check With Displacement Information**

Format 5 is generated when:

- Data checks that are correctable by the ECC are detected in the data areas of a record.
- Data checks in data areas that are not correctable by the ECC were successfully retried but the file mask specified PCI fetch mode.
- Error log information is off-loaded after an ECC correctable error occurred during error logging.
- Data checks are detected while processing a second or subsequent segment of an overflow record.

### **Bytes 8 through 12 - Count ID**

Bytes 8 through 12 contain the record ID obtained from the count field of the record in which the error occurred.

### **Byte 13 - Sector Number**

Byte 13 contains the sector number of the record in error.

### **Byte 14**

Byte 14 is not used.

### **Bytes 15 through 17**

Bytes 15 through 17 contain the restart displacement.

### **Bytes 18 and 19**

Bytes 18 and 19 contain the error displacement.

### **Bytes 20 through 22**

Bytes 20 through 22 contain the error pattern.

### **Byte 23**

Byte 23 is not used.

## Message Table – Format 5

Sense Byte 7, Bits 4-7 =	Message Code	Message
0000-0010	0-2	Not used.
0011	3	Data area data check.
0100-1111	4-F	Not used.

## Format 6 – Usage Statistics/Overrun Errors

Format 6 is generated when:

- A Read and Reset Buffered Log command is executed.
- Usage/error statistics require off-loading due to counter overflow.

### Bytes 8 through 11 - Bytes Read or Searched

Bytes 8 through 11 contain an accumulated count of the number of bytes processed by the storage director during read and search operations. (Only key and data area bytes are counted.) Bytes processed during retry operations are not counted.

### Bytes 12 and 13

Bytes 12 and 13 are not used.

### Bytes 14 and 15

Bytes 14 and 15 contain the number of ECC uncorrectable data errors retried by the store director.

### Bytes 16 and 17 - Number of Seeks

Bytes 16 and 17 contain the number of seek commands processed by the storage director.

### Byte 18 - Channel Select

Byte 18 specifies which channels the information in bytes 20 through 23 pertain to.

If bits 0 and 1 are:

00 = channels A and B	01 = channels E and F
10 = channels C and D	11 = channels G and H

Bits 2 through 7 are not used.

### Byte 19 - Seek Errors

Byte 19 contains the number of seek errors retried by the storage director.

### Byte 20 - Command Overruns - Channel A, C, E, or G

Byte 20 indicates that a command overrun occurred on the channel specified by byte 18 bits 0 and 1.

00 = channel A	01 = channel E
10 = channel C	11 = channel G

### Byte 21 - Data Overruns - Channel A, C, E, or G

Byte 21 indicates that a data overrun occurred on the channel specified by byte 18 bits 0 and 1.

00 = channel A	01 = channel E
10 = channel C	11 = channel G

### Byte 22 - Command Overruns - Channel B, D, F, or H

Byte 22 indicates that a command overrun occurred on the channel specified by byte 18 bits 0 and 1.

00 = channel B	01 = channel F
10 = channel D	11 = channel H

### Byte 23 - Data Overruns - Channel B, D, F, or H

Byte 23 indicates that a data overrun occurred on the channel specified by byte 18 bits 0 and 1.

00 = channel B	01 = channel F
10 = channel D	11 = channel H

### Message Table – Format 6

<b>Sense Byte 7, Message</b>		
<b>Bits 4-7 =</b>	<b>Code</b>	<b>Message</b>
0000-0111	0-7	Not used.
1000	8	3880 offload.
1001-1111	9-F	Not used.

## Error Condition Table – 3330 and 3350

Byte	Bit	Name	General Description	Action	Logged
0	0	Command reject	Programming error.	2	No
0 1	0 6	Command reject Write inhibited	A Write command received with the Write Inhibit switch in the Read-Only position.	1	No
0	1	Intervention required	Define offline or not plugged for the address.	3	No-3330 Yes-3350 (See Note)
0	2	Bus out parity	Bus out parity error.	3	Yes
0	3	Equipment check	Equipment malfunction.	4	Yes
0 1	3 0	Equipment check Permanent error	Equipment malfunction Storage director retry exhausted or undesirable.	1	Yes
0 1	3 3	Equipment check Message to operator	Permanent equipment malfunction of the alternate storage director or a state save operation in reporting storage director.	4A	Yes
0 1	3 6	Equipment check Write Inhibited	Write operations are inhibited on the data path by the execution of a Diagnostic Control command.	4B	Yes
0	4	Data check	Data check not correctable with a Read Multiple CKD command.	4	No
0 1	4 0	Data check Permanent error	Uncorrectable data check, storage control retry exhausted.	1	Yes
0 1	4 7	Data check Operation incomplete	Data check in the second or subsequent overflow segment but not a data field correctable error.	6A	No-3330 Yes-3350
0 1 2	4 7 1	Data check Operation incomplete Correctable	Correctable data check in the data area of an overflow segment, not the last segment.	6	No-3330 Yes-3350
0 2	4 1	Data check Correctable	Correctable data check in the data area, data area of the last overflow segment, or Read Multiple CKD.	5	No-3330 Yes-3350
0	5	Overrun	Service overrun on second or subsequent segment of an overflow record, a format write, Read Multiple CKD, or storage control retry exhausted.	4	Yes
1	1	Invalid track format	Track capacity exceeded.	2	No
1	2	End of cylinder	Cylinder boundary detected during a multitrack operation.	8	No

Byte	Bit	Name	General Description	Action	Logged
1 1	2 7	End of cylinder Operation incomplete	Cylinder boundary detected during an overflow operation.	9	No
1	4	No record found	Record not found in the basic command sequence.	2	No
1	5	File protected	The Seek command or read and/or search multitrack operation violated the file mask.	10	No
1 1	5 7	File protected Operation incomplete	A read or write overflow violated the file mask.	11	No
1	7	Operation incomplete	After start of data transfer during an overflow operation, either a defective or alternate track condition, or a seek error in the second or subsequent segment was found.	7	No
2	3	Environmental data present	Statistical usage/error log information is present.	3	Yes

*Note: For the 3350, if sense byte 10, bits 4 and 5 are 0, no recording action is performed.*

## Recovery Action Table – 3330 and 3350

Action	Explanation
--------	-------------

- |   |  |
|---|--|
| 1 | Print console error message.   |
| 2 | Exit with programming error or unusual condition indication.   |
| 3 | a. Repeat the operation once.<br>b. If the error condition persists, do action 1.  |
| 4 | a. Repeat the operation using the same data path.<br>b. If the error condition persists after ten entries, examine sense byte 2 bit 6 (write operation). If this bit is off, do steps d and e only. Otherwise, do steps c, d, and e.<br>c. Issue the Diagnostic Control command with the Inhibit Write subcommand to the storage director. |

*Note: For Format 1, do not issue the Diagnostic Control command. Do steps d and e. Determine the subcommand modifier by examining the sense data as follows:*

For Format 0, set the modifier to X'40'.

For Format 2, examine the fault symptom code (sense bytes 22-23). If it is X'270X' or X'27FX' (X is any number between 0 and 7), then set the modifier to X'40'. Otherwise, set the modifier to X'80'.

- |    |  |
|----|--|
|    | d. Print console message requesting CE notification.   |
|    | e. If an alternate path is available, repeat the operation using the alternate data path.  |
| 4A | a. Print the console message requesting CE notification<br>b. Repeat the operation once.<br>c. If the error condition persists, do action 1.     |
| 4B | a. Print the console error message requesting.<br>b. If an alternate data path is available, repeat the operation using the alternate data path. |

**Action Explanation**

- 5
- a. Perform the error correction function.
  - b. Examine bit 7 of the file mask. If off, go to step c. If on, indicate that the data has been corrected. The user is operating in PCI fetch mode and must supply the restart recovery action.
  - c. Examine the interrupted CCW (indicated CCW address minus 8). If it is a Read Multiple CKD (X'5E'), do action 5B; otherwise continue. If the user's chain is not complete, examine the next non-TIC Sector, Space Count, or if bit 3 of the CCW is 1, go to step d; otherwise, do action 5A.
  - d. Continue the user's chain by executing:

Seek	(see Note below)
Set File Mask	(same as original)
Read Home Address	(skip bit on)
Search ID Equal	(CCHHR from sense bytes 8 through 12)
TIC*.8	
TIC (ICCW Address)	(indicated CCW address)

- 5A Continue the user's chain by executing:

Seek	(see Note below)
Set File Mask	(same as original)
Read Home Address	(skip bit on)
Search ID Equal	(CCHHR from sense bytes 8 through 12)
TIC*.8	
Read Count	(skip bit on)
TIC (ICCW Address)	(indicated CCW address)

- 5B This action is used to restart a Read Multiple CKD data recovery process after a correctable data check has been processed. Rebuild the Read Multiple CKD as follows:

- a. Build restart CCW 2.
- b. Set command code to X'5E'

Restart the operation by executing:

Seek	(see Note below)
Set File Mask	(same as original)
Read Home Address	(skip bit on)
Search ID Equal	(CCHHR from sense bytes 8 through 12)
TIC*.8	
Read Multiple CKD	(from step a and b)
TIC (ICCW Address)	(indicated CCW address)

*Note: Cylinder bytes and the high-order head bytes are obtained from the user, not from the sense bytes. The low-order head byte is obtained from sense byte 6, bits 3 through 7.*



**Action Explanation**

- 6
- a. Perform the error correction function.
  - b. Examine bit 7 of the file mask (PCI). If off, go to step c. If on, return to the user with an indication that the data has been corrected. The user is operating in PCI fetch mode and must supply the restart recovery action.
  - c. Increment the seek argument by 1. (See Note below.)
  - d. Build restart CCW 2.
  - e. Complete the interrupted operation and continue the user's chain (if appropriate) by executing:

Seek	(increment seek argument by 1; see Note below)
Set File Mask	(same as original)
Set Sector	(argument 0)
Search ID Equal	(record 1)
TIC*8	
Restart CCW 2	
TIC	(pointer established while building restart CCW 2 + 8)

If the modified seek argument is not within the user's extent, IOS must supply the correct seek argument before issuing the Seek. If that is impossible, then IOS must do action 2.

- 6A
- a. Examine bit 7 of the file mask (PCI). If off, go to step b. If on, indicate that data has been corrected. The user is operating in PCI fetch mode and must supply the restart recovery action.
  - b. Build restart CCW 2.
  - c. Complete the interrupted operation and continue the user's chain (if appropriate) by executing:

Seek	(see Note below)
Set File Mask	(same as original)
Set Sector	(argument 0)
Search ID Equal	(record 1)
TIC*8	
Restart CCW 2	
TIC	(pointer established while building restart CCW 2 + 8)

- 7
- a. Build restart CCW 1.
  - b. Continue the user's chain by executing:

Seek	(see Note below)
Set File Mask	(same as original)
Set Sector	(argument 0)
Search ID Equal	(record 1)
TIC*8	
Restart CCW 2	
TIC (ICCW Address)	(indicated CCW address)

*Note: Cylinder bytes and the high-order head bytes are obtained from the user, not from the sense bytes. The low-order head byte is obtained from sense byte 6, bits 3 through 7.*

**Action Explanation**

- 8 a. Increment the cylinder address of the user's seek argument by 1.  
Reset the head address.  
b. Continue the operation by executing:

Seek (argument from step a)  
Set File Mask (same as original)  
Set Sector (argument 0)  
Read Home Address (skip bit is on)  
TIC (ICCW Address -8) (indicated CCW address minus 8)

If the modified seek argument is not within the user's extent, IOS must supply the correct seek argument before issuing the Seek. If that is impossible, IOS must do action 2.

- 9 a. Increment the cylinder address of the user's seek argument by 1.  
Reset the head address.  
b. Build restart CCW 1.  
c. Complete the interrupt operation and continue the user's chain (if appropriate) by executing:

Seek (argument from step a)  
Set File Mask (same as original)  
Set Sector (argument 0)  
Search ID Equal (record 1)  
TIC \*-8  
Restart CCW 1  
TIC (ICCW Address) (indicated CCW address)

If the modified seek argument is not within the user's extent, IOS must supply the correct seek argument before issuing the Seek. If that is impossible, IOS must do action 2.

- 10 a. Determine if the interrupted command is a seek. If it is, go to step b. If not, do action 10A.  
b. Continue the operation by executing:

Seek (user's argument)  
Set File Mask (same as original)  
Set Sector (argument 0)  
Read Home Address (skip bit on)  
TIC (ICCW Address) (indicated CCW address)

If the seek argument is not within the user's extent, IOS must supply the correct seek argument before issuing the Seek. If that is impossible, IOS must do action 2.

**Action Explanation**

- 10A a. This is a multitrack operation. Increment the user's seek argument by 1.  
b. Continue the operation by executing:

Seek (argument from step a)  
Set File Mask (same as original)  
Set Sector (argument 0)  
Read Home Address (skip bit on)  
TIC (ICCW Address -8) (indicated CCW address -8)

If the modified seek argument is not within the user's extent, IOS must supply the correct seek argument before issuing the Seek. If that is impossible, IOS must do action 2.

- 11 a. Increment the user's seek argument by 1.  
b. Build restart CCW 1.  
c. Complete the interrupted operation and continue the user's chain (if appropriate) by executing:

Seek (argument from step a)  
Set File Mask (same as original)  
Set Sector (argument 0)  
Search ID Equal (record 1)  
TIC \*-8  
Restart CCW 1  
TIC (ICCW Address) (indicated CCW address)

If the modified seek argument is not within the user's extent, IOS must supply the correct seek argument before issuing the Seek. If that is impossible, IOS must do action 2.

## Chapter 10. Sense Bytes – 3340 and 3344

Sense information for the 3340 (24 bytes) identifies the condition that caused the last unit check status to be generated. The sense information also provides secondary information for system error recovery and for diagnosing and isolating storage director and device malfunctions.

### Sense Byte 0

#### Bit 0 - Command Reject

Bit 0 is set by:

- An invalid command code.
- An invalid command sequence.
- An invalid or incomplete argument transferred by a control command.
- A track formatted without a home address.
- Issuing a write command with the Write Inhibit switch in the Read-Only position.
- Attempting a format write command (other than Write Home Address or Write R0) on a defective track.
- Issuing a write command that violates the file mask.
- A record zero count field of a defective track that points to itself instead of the alternate track.

#### Bit 1 - Intervention Required

Bit 1 is set by:

- Addressing a drive that is not attached to the system.
- Addressing a drive that is not ready.
- Issuing a Diagnostic Write or Diagnostic Load command while an inline diagnostic is resident in control storage.

### **Bit 2 - Bus Out Parity Check**

Bit 2 is set when a parity error is detected during transfer of a command from the channel to the 3880.

### **Bit 3 - Equipment Check**

Bit 3 is set when an unusual hardware condition occurs in the channel, storage director, or drive. The condition is further defined in sense bytes 7 through 23.

### **Bit 4 - Data Check**

Bit 4 is set when the storage director detects a data error in the information received from the drive. If byte 2, bit 1 (correctable) is also set, the data error is correctable and bytes 15 through 23 provide correction information. If the data error is uncorrectable, sense byte 7 defines the specific nature of the condition.

### **Bit 5 - Overrun**

Bit 5 is set when the storage director does not receive a response to a data request within a specified period or when a command overrun occurs. Format 0, message B is set on command overrun; Format 0, message C is set on data overrun.

Detection of an overrun may cause requests for data from the channel to be terminated. When writing, the remaining portion of the record area is padded with a replicated data byte.

### **Bit 6 - Track Condition Check**

Bit 6 is set when:

- Any read or search command (other than Search Home Address, Read Home Address, or Read RO) has been attempted on a defective track.
- A read or search command is to continue from an alternate track to the next higher track address because of multitrack operations.

When byte 1, bit 7 (operation incomplete) is set with this bit, it indicates a read, search, or update write on an overflow segment (other than the first segment).

### **Bit 7 - Seek Check**

Bit 7 is set when a seek operation is incomplete or when an incorrect physical address is detected when reading a home address or count area.

## Sense Byte 1

### Bit 0

Not used.

### Bit 1 - Invalid Track Format

Bit 1 is set when:

- Attempting to write data exceeding track capacity.
- Detecting an index point in the gap that precedes a key or data field.

### Bit 2 - End of Cylinder

Bit 2 is set when:

- A multitrack read or search operation continues past the end of the cylinder boundary.
- An overflow operation continues past the end of the cylinder boundary. Byte 1, bit 7 (operation incomplete) is also set.

### Bit 3 - Message to Operator

Bit 3 is set when there is a permanent failure in the alternate storage director or a state save operation in the reporting storage director. Byte 0, bit 3 (equipment check) is also set. A message is sent to the operator.

### Bit 4 - No Record Found

Bit 4 is set when the index point at the beginning of the selected logical track has been detected twice in the same CCW chain without an intervening read operation in the home address area or data area, or without an intervening write, sense, or control command.

### Bit 5 - File Protected

Bit 5 is set when:

- A seek command violates the file mask.
- A multitrack read or search operation violates the file mask.
- An overflow operation violates the seek portion of the file mask. Byte 1, bit 7 (operation incomplete) is also set.

### **Bit 6 - Write Inhibited**

Bit 6 is set when a write command is received for a drive that has the Write Inhibit switch in the Read-Only position. Byte 0, bit 0 (command reject) is also set.

### **Bit 7 - Operation Incomplete**

Bit 7 is set when one of the following conditions occurs during the processing of an overflow record.

- An overflow to a file protected boundary occurs. Byte 1, bit 5 (file protected) is also set.
- An overflow past the cylinder boundary occurs. Byte 1, bit 2 (end of cylinder) is also set.
- A correctable data check is detected in a data field other than the last segment. Byte 0, bit 4 (data check) and byte 2, bit 1 (correctable) are also set.
- An uncorrectable data check is detected in a data field in other than the first segment.
- A defective or alternate track condition is detected after the start of data transfer.

Sense byte 3 provides the restart command, and sense bytes 8 through 13 provide restart information.

## **Sense Byte 2**

### **Bit 0 - RPS Present**

Bit 0 is set when the RPS feature is installed in the 3340. (Bit 0 is always on for the 3344.)

### **Bit 1 - Correctable**

Bit 1 is set when the data check condition indicated by byte 0, bit 4 (data check) is correctable.

### **Bit 2**

Bit 2 is not used. It is set to zero.

### Bit 3 - Environmental Data Present

Bit 3 is set when sense Format 6 is presented. Sense Format 6 is presented when:

- An error counter overflows (not overrun).
- The storage director is in force-error-log mode.
- A Read and Reset Buffered Log command is executed.

### Bit 4 - Drive Type

Bit 4 indicates the type of drive: 0 = 3340, 1 = 3344.

### Bits 5 through 7 - Data Storage Size

Bits 5 through 7 identify the size and type of data storage on the selected drive.

DM Size	Bit 5	Bit 6	Bit 7
35 MB	0	0	1
70 MB*	0	1	0
Fixed Head**	1	1	0

\* Presented on all 3344 logical addresses

\*\* Presented only on this primary logical volume of the 3344

### Sense Byte 3

#### Bits 0 through 7 - Restart Command

Bits 0 through 7 are set when byte 1, bit 7 (operation incomplete) is set. These bits identify the type of operation in progress when the interrupt occurred. If the bits are set to 0000 0110, a read operation was in progress; if they are set to 0000 0101, a write operation was in progress.

When byte 1, bit 7 is zero, byte 3 is zero.



## Sense Byte 4

### Bits 0 through 7 - 3340 Drive Identification

Bits 0 through 7 identify the physical drive selected when a unit check occurred.

Bit	Drive	Bit	Drive
0	A	4	E
1	B	F	
2	C	6	G
3	D	7	H

### Bits 0 through 7 - 3344 Drive Identification

Bits 0-1 = String address    Bit 4 = Not used  
Bit 2 = Not used            Bits 5-7 = Drive address  
Bit 3 = Not used

## Sense Byte 5

### Bits 0 through 7 - Cylinder-Low Address

Bits 0 through 7 identify the low-order cylinder address of the most recent seek argument from the channel.

Bit 0 = Cylinder 128	Bit 4 = Cylinder 8
Bit 1 = Cylinder 64	Bit 5 = Cylinder 4
Bit 2 = Cylinder 32	Bit 6 = Cylinder 2
Bit 3 = Cylinder 16	Bit 7 = Cylinder 1

With sense Format 3 (microcode detected), byte 5 indicates the high-order byte of the instruction address register.

With sense Format 6, byte 5 indicates the number of diskette checks after an initial microcode load (IML) or a storage director-to-storage director communication failure.

Bit 0 = Communication failure during an IML	Bits 2-4 = Diskette check (seek errors)
Bit 1 = Not used	Bits 5-7 = Diskette check (read errors)

## Sense Byte 6

### Bits 0 through 7 - Cylinder-High and Head Address

Bits 0 through 7 identify the high-order cylinder and head address of the most recent seek argument from the channel.

Bit 0 = 0 for 3340 or 1024 for 3344	Bit 4 = Logical track 8
Bit 1 = Cylinder 512	Bit 5 = Logical track 4
Bit 2 = Cylinder 256	Bit 6 = Logical track 2
Bit 3 = 0 for 3340 or 2048 for the 3344	Bit 7 = Logical track 1

Operations involving head switching update the head address bits (4 through 7) of this byte.

If an alternate track condition is detected and byte 1, bit 7 (operation incomplete) is presented during an overflow operation, byte 6 is set to the head address of the defective track and incremented by 1. The error recovery procedures use this byte to build the seek argument to continue the operation.

With sense Format 3 (microcode detected), byte 6 indicates the low-order byte of the instruction address register.

With sense Format 6, byte 6 identifies the storage director.

## Sense Byte 7

### Bits 0 through 3 - Format

Bits 0 through 3 specify the format of sense byte 8 through 23 as follows:

0000 = Format 0 – program or system check
0001 = Format 1 – device equipment check (CE information)
0010 = Format 2 – storage director equipment check (CE information)
0011 = Format 3 – storage director control check (CE information)
0100 = Format 4 – data checks without displacement information (uncorrectable data checks)
0101 = Format 5 – data check with displacement information (correctable data checks)
0110 = Format 6 – usage statistics/overrun errors.

### Bits 4 through 7 - Message Code

Bits 4 through 7 describe the specific nature of the error conditions for each of the above formats. The message table that accompanies the format descriptions specifies the function of the message bits for the format.

## Format 0 – Program or System Check

Format 0 is used when sense bytes 0 through 7 completely describe the error or unusual condition caused by a program or system error.

### Bytes 8 through 20

Bytes 8 through 20 are not used for 3340 or 3344 operations. They are set to 0.

### Byte 21

Storage director ID.

### Bytes 22 and 23 - Skip Displacement

If a Sense command is chained from a successful Read Home Address command, bytes 22 and 23 contain the skip displacement bytes of the track. These bytes are not valid for other operations.

## Message Table – Format 0

Sense Byte 7, Bits 4-7 =	Message Code	Message
0000	0	No message. No additional information required.
0001	1	An invalid command was issued to the 3880.
0010	2	An invalid command sequence was issued to the 3880.
0011	3	The CCW count was less than required for the command.
0100	4	An invalid data argument was used for the command.
0101	5	A Diagnostic Write command was issued when not permitted by the file mask.
0110	6	Retry status was presented but the channel did not indicate chaining.
0111	7	The command code of the CCW that was returned after a retry sequence did not match the command for which the retry was signaled.
1000	8	A Diagnostic Load command was issued but the IML device was not ready.
1001	9	A Diagnostic Load command was issued but the IML device had a permanent seek check.
1010	A	A Diagnostic Load command was issued but the IML device had a permanent read check.
1011	B	A command was received too late to be executed by the storage director and/or device.
1100	C	A response to a data request was not received by the storage director within a specified time.

<b>Sense Byte 7, Bits 4-7 =</b>	<b>Message Code</b>	<b>Message</b>
1101	D	<ul style="list-style-type: none"> <li>• A single track command other than Read Home Address, Search Home Address, Read RO, Write Home Address, or Write RO, was executed on a defective track.</li> <li>• A multitrack command or overflow record operation attempted to switch from a defective track.</li> <li>• A multitrack or overflow operation other than Read Home Address, Read RO, or Search Home Address, switched to a defective track.</li> <li>• A defective track condition was detected after start of data transfer during processing of an overflow record.</li> </ul>
1110	E	A multitrack or overflow record operation attempted to switch from an alternate track.
1111	F	Not used.

## Format 1 – Device Equipment Check

Format 1 is generated when:

- A device, device interface, or a controller equipment check is detected. Byte 0, bit 3 (equipment check) is also set.
- A permanent device seek check is detected. Byte 0, bit 3 (equipment check) and byte 1, bit 0 (permanent error) are also set. The message bits in sense byte 7 indicate a seek error.
- Error log information is off-loaded after a successful retried seek that occurred during error logging. Byte 3, bit 2 (environmental data present) is also set. The message bits in sense byte 7 indicate a seek error.
- Byte 8, bit 4 (on line) is off. Byte 0, bit 1 (intervention required) is also set.

### Byte 8 - Drive Status

When byte 19, bit 0 (set R/W) is on:

Bit 0 = Controller check  
Bit 1 = Device interface check  
Bit 2 = Drive check  
Bit 3 = R/W check  
Bit 4 = On line  
Bit 5 = Data module attention  
Bit 6 = Busy  
Bit 7 = Seek complete, search sector,  
or pad complete

When byte 19, bit 0 is off:

Bit 0 = Controller check  
Bit 1 = Device interface check  
Bit 2 = Drive check  
Bit 3 = R/W check  
Bit 4 = On line  
Bit 5 = I (current) write sense  
Bit 6 = Index mark  
Bit 7 = Active track

### Byte 9 - Drive Checks

Bit 0 = DM loaded switch latched	Bit 4 = Write enable
Bit 1 = Sector compare check	Bit 5 = FH DM size 4
Bit 2 = Motor-at-speed switch latched	Bit 6 = DM size 2 (70 MB)
Bit 3 = Air/belt switch latched	Bit 7 = DM size 1 (35 MB)

### Byte 10 - DM Sequence Control

Bit 0 = DM size check	Bit 4 = Check latch
Bit 1 = DM latch 4	Bit 5 = DM sequence check latched
Bit 2 = DM latch 2	Bit 6 = Bias disable switch
Bit 3 = DM latch 1	Bit 7 = Odd physical track

### Byte 11 - Load Switch Status

Bit 0 = Drive start switch	Bit 4 = DM loaded switch
Bit 1 = DM present switch	Bit 5 = Belt switch
Bit 2 = Cover locked switch	Bit 6 = Carriage home
Bit 3 = DM unloaded switch	Bit 7 = Air motor-at-speed switch

### Byte 12 - R/W Safety

Bit 0 = Multiple-head select check	Bit 4 = R/W interlock check
Bit 1 = Capable/enable check	Bit 5 = Control check
Bit 2 = Write overrun	Bit 6 = Write transition check
Bit 3 = Index check	Bit 7 = Write current during read check

### Byte 13 - Control Interface Check

When byte 0, bit 7 (seek check) is off, bits 0 through 3 contain the control interface bus out value for message code C, and bits 4 through 7 contain the expected status for messages 1, 3, 5, 6, 7, 8, and 9.

When byte 0, bit 7 is on, byte 13 indicates the previous seek address and the logical cylinder and head address for 3340s, or the physical cylinder and track address for 3344s.

#### 3340

Bit 0 = Not used  
Bit 1 = 512  
Bit 2 = 256  
Bit 3 = Not used  
Bit 4 = 8  
Bit 5 = 4  
Bit 6 = 2  
Bit 7 = 1

#### 3344

Bit 0 = 512  
Bit 1 = 256  
Bit 2 = 32  
Bit 3 = 16  
Bit 4 = 8  
Bit 5 = 4  
Bit 6 = 2  
Bit 7 = 1

### Byte 14 - Control Interface Bus In

When byte 0, bit 7 (seek check) is off, byte 14 contains the control interface bus in for message codes 1, 3, 5, 6, 7, 8 and 9 and for message code 2 if byte 18 equals X'01', X'03', X'05', or X'06'.

When byte 0, bit 7 is on, byte 14 indicates the high-logical cylinder address and the head address for 3340s and the high-physical cylinder and physical track address for 3344s.

#### 3340

Bit 0 = Not used  
Bit 1 = 512  
Bit 2 = 256  
Bit 3 = Not used  
Bit 4 = 8  
Bit 5 = 4  
Bit 6 = 2  
Bit 7 = 1

#### 3344

Bit 0 = 512  
Bit 1 = 256  
Bit 2 = 32  
Bit 3 = 16  
Bit 4 = 8  
Bit 5 = 4  
Bit 6 = 2  
Bit 7 = 1

### Byte 15 - Control Interface Tag Bus

Byte 15 contains the control interface tag bus value for message codes 1, 3, 5, 6, 7, 8, and 9.

### Byte 16 - Access Status

Bit 0 = Access time out	Bit 4 = Servo latch
Bit 1 = Overshoot check	Bit 5 = Linear mode latch
Bit 2 = Servo off-track check	Bit 6 = Control latch
Bit 3 = Track crossing	Bit 7 = Wait latch

### Byte 17 - Controller Checks

Bit 0 = PLO check	Bit 4 = Write data check
Bit 1 = No PLO input check	Bit 5 = Monitor check
Bit 2 = SERDES check	Bit 6 = ECC check
Bit 3 = Gap counter check	Bit 7 = ECC zero detected

### Byte 18 - Microcode Detected Errors

Bits 0 through 3 are not used. Bits 4 through 7 indicate the following error conditions:

0000 = Not used.
0001 = Tag Valid indication missing on a read or write operation.
0010 = Normal End or Check End indication missing on a read, write, or ECC operation.
0011 = No response from the controller on a control operation.
0100 = A time out occurred while waiting for index or active track.
0101 = ECC hardware check.
0110 = Either more than one controller was selected or no controller was selected.
0111 = Preselection check.
1000 = Repetitive command overruns on gap 1 operations.
1001 = Busy missing after seek start was issued.
1010 = Incorrect drive selected.
1011 = Not used.
1100 = Invalid Check End indication.
1101 = After a successful comparison, the physical address did not compare.
1110 = Active CTL-I bus.
1111 = Attention check.

### Byte 19 - Status

3340	3344
Bit 0 = Set R/W on	Bit 0 = Set R/W on
Bit 1-4 = Not used	Bits 1-3 = Not used
Bit 5 = Low-gain error	Bit 4 = Head short check
Bit 6 = Not used	Bits 5,6 = Not used
Bit 7 = Fixed head feature	Bit 7 = Always on

## Byte 19 - Status

### 3340

Bit 0 = Set R/W on  
Bit 1-4 = Not used  
Bit 5 = Low-gain error  
Bit 6 = Not used  
Bit 7 = Fixed head feature

### 3344

Bit 0 = Set R/W on  
Bits 1-3 = Not used  
Bit 4 = Head short check  
Bits 5,6 = Not used  
Bit 7 = Always on

## Byte 20 - Interface Checks

When byte 0, bit 7 is off, the bits in byte 20 have the following meaning:

Bit 0 = Control interface tag bus parity check  
Bit 1 = Control interface bus out parity check  
Bit 2 = Drive selection check  
Bit 3 = Device bus in parity check  
Bit 4 = Control interface bus in parity check  
Bit 5 = I (current) write failure  
Bit 6 = Device bus out parity check  
Bit 7 = Device tag parity check

When byte 0, bit 7 is on and message A is indicated in Format 1, byte 20 contains the present seek address and low-logical cylinder address for 3340s, or the low-physical cylinder address for 3344s. If the fixed head feature is installed, bits 0 through 6 are zero; and bit 7, when on, = X'64'.

## Byte 21

When byte 0, bit 7 (seek check) is off, byte 21 contains the physical drive identification for 3344 attachment and is not used for 3340 attachment.

When byte 0, bit 7 is on and message A is indicated in Format 1, byte 21 contains the high-logical cylinder address and the head address for 3340s; and contains the high-physical cylinder and physical track addresses for 3344s. If the fixed head feature is installed, bits 0 and 1 are set to 1.

### 3340

Bit 0 = Not used  
Bit 1 = 512  
Bit 2 = 256  
Bit 3 = Not used  
Bit 4 = 8  
Bit 5 = 4  
Bit 6 = 2  
Bit 7 = 1

### 3344

Bit 0 = 512  
Bit 1 = 256  
Bit 2 = 32  
Bit 3 = 16  
Bit 4 = 8  
Bit 5 = 4  
Bit 6 = 2  
Bit 7 = 1



## Bytes 22 and 23

Bytes 22 and 23 contain the symptom code.

### Message Table – Format 1

Sense Byte 7, Message		
Bits 4-7 =	Code	Message
0000	0	No message. No additional information is required.
0001	1	Set target error.
0010	2	Microcode detected error.
0011	3	Transmit fixed head error (3340) or transmit difference high error (3344).
0100	4	Sync-out timing error.
0101	5	Unexpected drive status at initial selection.
0110	6	Transmit cylinder address error (string switch only).
0111	7	Transmit head error.
1000	8	Transmit difference error.
1001	9	Unexpected drive status.
1010	A	Seek error.
1011	B	Seek incomplete on retry.
1100	C	No interrupt from drive.
1101	D	Reorientation check.
1110	E	Unable to determine data module type during initial selection (3340 only).
1111	F	Not used.

## Format 2 – Storage Director Equipment Check

Format 2 is generated when the microcode detects a storage director error condition.

<b>Byte 8</b>	Contents of the transfer complete status (XCS) register.
<b>Byte 9</b>	Contents of the transfer error status (XES) register.
<b>Byte 10</b>	Contents of the check register.
<b>Byte 11</b>	Contents of the channel transfer complete (CXC) register.
<b>Byte 12</b>	Contents of channel control 2 register.
<b>Byte 13</b>	Contents of the device bus out (DBO) register.
<b>Byte 14</b>	Contents of the device bus in (DBI) register.
<b>Byte 15</b>	Contents of the device tag out (DTO) register.
<b>Byte 16</b>	Contents of the device tag gate (DTG) register.
<b>Byte 17</b>	Contents of the device tag in (DTI) register.
<b>Byte 18</b>	Contents of channel status 2 register.
<b>Byte 19</b>	Not used.
<b>Byte 20</b>	Reserved for microcode detected check 2 conditions.
<b>Byte 21</b>	Storage director ID.
<b>Bytes 22 and 23</b>	Symptom code.

## Message Table – Format 2

<b>Sense Byte 7, Message</b>		
<b>Bits 4-7 =</b>	<b>Code</b>	<b>Message</b>
0000-0111	0-7	Reserved for other types of storage control units.
1000	8	No message. No additional information required.
1001	9	Selective reset occurred while the drive was selected.
1010	A	Failed to latch the First Sync In line.
1011-1111	B-F	Reserved.

### Format 3 – Storage Director Control Check (Hardware Detected)

Format 3 is generated to provide sense information for a failing storage director that requires a reset procedure for recovery.

Byte 8	Contents of the FRU register 2 (bit 4 = 0).
Byte 9	Contents of check register 1.
Byte 10	Contents of check register 2.
Byte 11	Contents of check register 3.
Byte 12	Not used.
Byte 13	Not used.
Byte 14	Not used.
Byte 15	Contents of FRU register 3.
Byte 16	Contents of FRU register 4.
Byte 17	Not used.
Byte 18	Not used.
Byte 19	Not used.
Byte 20	Not used.
Byte 21	Storage director ID.
Bytes 22 and 23	Symptom code.

### Message Table – Format 3

Sense Byte 7, Message		
Bits 4-7 =	Code	Message
0000-0111	1-7	Reserved for other types of storage control units.
1000	8	No message. No additional information required.
1001	9	Channel check 1 or storage director timeout.
1010-1111	A-F	Reserved.

### Format 3 – Storage Director Control Check (Microcode Detected)

<b>Byte 8</b>	Byte 8 not used.
<b>Byte 9</b>	Contents of the transfer error status (XES) register.
<b>Byte 10</b>	Contents of the check register.
<b>Byte 11</b>	Contents of the condition register 0 (CRO).
<b>Byte 12</b>	Contents of the channel status 2 (CS2) register.
<b>Byte 13</b>	Contents of the channel control 1 (CC1) register.
<b>Byte 14</b>	Contents of the channel control 2 (CC2) register.
<b>Byte 15</b>	Contents of the channel status 1 (CS1) register.
<b>Byte 16</b>	Contents of the channel status 3 (CS3) register.
<b>Byte 17</b>	Contents of the channel transfer control (CXC) register.
<b>Byte 18</b>	Contents of the channel bus out (CBO) register.
<b>Byte 19</b>	Contents of the channel bus in (CBI) register.
<b>Byte 20</b>	Contains the timeout message when sense bytes 22 and 23 contain a symptom code of 3F2X. Otherwise, this byte is the interrupt level.
<b>Byte 21</b>	Storage director ID.
<b>Bytes 22 and 23</b>	Symptom code.

### Message Table – Format 3

#### Sense Byte 7, Message

Bits 4-7 =	Code	Message
0000-1000	0-8	Reserved.
1001	9	Channel check 1 or storage director timeout.
1010	A	Trace table saved in this storage director.
1011-1111	B-F	Reserved.

## **Format 4 – Data Check Without Displacement Information**

Format 4 is generated when:

- Errors that are not correctable by the ECC are detected after retry has been unsuccessful. Byte 1, bit 0 (permanent error) is also set.
- Error log information is off-loaded after an ECC uncorrectable error occurred during error logging. The information is recovered through use of command retry. Byte 2, bit 3 (environmental data present) is also set.

### **Bytes 8 through 12 - Count ID**

Bytes 8 through 12 contain the record ID obtained from the count field of the record in which the error occurred. These bytes are unreliable if the message code in byte 7 is 0, 1, 4, or 5. Byte 12 is unreliable after a Space Count command.

### **Byte 13 - Sector Number**

Byte 13 contains the sector number.

### **Byte 14 through 21**

Bytes 14 through 21 are not used.

### **Bytes 22 and 23**

Bytes 22 and 23 contain the symptom code.

## Message Table – Format 4

<b>Sense Byte 7, Message</b>		
<b>Bits 4-7 =</b>	<b>Code</b>	<b>Message</b>
0000	0	An error occurred in the home address area and could not be corrected by the ECC.
0001	1	An error occurred in the count area and could not be corrected by the ECC.
0010	2	An error occurred in the key area and could not be corrected by the ECC.
0011	3	An error occurred in the data area and could not be corrected by the ECC.
0100	4	Data synchronization on the home address area was unsuccessful.
0101	5	Data synchronization on the count area was unsuccessful.
0110	6	Data synchronization on the key area was unsuccessful.
0111	7	Data synchronization on the data area was unsuccessful.
1000-1111	8-F	Not used.

## **Format 5 – Data Check With Displacement Information**

Format 5 is generated when:

- Data checks that are correctable by the ECC are detected in the data area of a record.
- Data checks in data areas that are not correctable by the ECC were successfully retried but the file mask specified PCI fetch mode.
- Error log information is off-loaded after an ECC correctable error occurred during error logging.
- Data checks are detected while processing a Read Multiple Count, Key, and Data command.

### **Bytes 8 through 12 - Count ID**

Bytes 8 through 12 contain the record ID obtained from the count field of the record in which the error occurred. These bytes are unreliable if the message code in byte 7 is 0, 1, 4, or 5. Byte 12 is unreliable after a Space Count command.

### **Byte 13 - Sector Number**

Byte 13 contains the sector number.

### **Byte 14**

Byte 14 is not used.

### **Bytes 15 through 17**

Bytes 15 through 17 contain the restart displacement.

### **Bytes 18 and 19**

Bytes 18 and 19 contain the error displacement.

### **Bytes 20 through 22**

Bytes 20 through 22 contain the error pattern.

### **Byte 23**

Byte 23 is not used.

## Message Table – Format 5

<b>Sense Byte 7, Message</b>		
<b>Bits 4-7 =</b>	<b>Code</b>	<b>Message</b>
0000-0010	0-2	Not used
0011	3	Error in the data area
0100-1111	4-F	Not used



## **Format 6 – Usage Statistics/Overrun Errors**

Format 6 is generated when:

- A Read and Reset Buffered Log command is executed.
- Usage/error statistics require off-loading because of counter overflow.
- When an overrun occurs, the appropriate counter is incremented. When it reaches X'FF', unit check is presented to the next initial selection sequence received.

### **Bytes 8 through 11 - Bytes Read or Searched**

Bytes 8 through 11 contain an accumulated count of the number of the bytes processed by the storage director during read and search operations. (Only key and data area bytes are counted.) Bytes processed during retry operations are not counted.

### **Bytes 12 through 15**

Bytes 12 through 15 are not used.

### **Bytes 16 and 17 - Number of Seeks**

Bytes 16 and 17 contain the number of seek commands processed by the storage director.

### **Byte 18 - Channel Select**

Byte 18 specifies which channel the information in bytes 20 through 23 pertain to. If bits 0 and 1 are:

00 = channels A and B  
10 = channels C and D

Bits 2 through 7 are not used.

### **Byte 19**

Byte 19 is not used.

### **Byte 20 - Command Overruns - Channel A or C**

Byte 20 contains the number of command overruns that occurred on channel A if bit 0 is 0, or on channel C if byte 18, bit 0 is 1.

### **Byte 21 - Data Overruns - Channel A or C**

Byte 21 contains the number of data overruns that occurred on channel A if byte 18, bit 0 is 0, or on channel C if byte 18, bit 0 is 1.

### **Byte 22 - Command Overruns - Channel B or D**

Byte 22 contains the number of command overruns that occurred on channel B if byte 18, bit 0 is 0, or on channel D if byte 18, bit 0 is 1.

### **Byte 23 - Data Overruns - Channel B or D**

Byte 23 contains the number of data overruns that occurred on channel B if byte 18, bit 0 is 0, or on channel D if byte 18, bit 0 is 1.

## **Message Table – Format 6**

### **Sense Byte 7, Message**

<b>Bits 4-7 =</b>	<b>Code</b>	<b>Message</b>
0000-0111	0-7	Not used
1000	8	3880 offload
1001-1111	9-F	Not used

## Error Condition Table – 3340 and 3344

Byte	Bit	Name	General Description	Action	Logged
0	0	Command reject	Programming error.	1	No
0 1	6	Command reject Write inhibited	A Write command received with the Write Inhibit switch in the Read-Only position.	1	No
0	1	Intervention required	Drive offline, not ready, CE mode, or data module incompatibility such as a 3348-70F installed on a drive that does not have the fixed head feature.	1	Yes
0	2	Bus out parity	Bus out parity error.	3	Yes
0	3	Equipment check	Equipment malfunction.	4	Yes
0 1	3 3	Equipment check Message to operator	Permanent equipment malfunction of the alternate storage director or a state save operation in the reporting storage director.	4B	Yes
0	4	Data check	Data check in home address, count area, or key area; or uncorrectable data check in data area.	4	Yes
0 1 2	4 7 1	Data check Operation incomplete Correctable	Correctable data check in the data area of an overflow segment, but not the last segment.	8	Yes
0 2 1 0	4 1 7 6	Data check Correctable Operation incomplete Track condition check	Correctable data check in the data area of an overflow segment (not the last segment) of an alternate track.	8A	Yes
0 2	4 1	Data check Correctable	Correctable data check in a non-multitrack data area or data area of the last overflow segment.	7	Yes
0	5	Overrun	Command retry exhausted on a service overrun.	4	Yes
0	6	Track condition check	Non-home address or record 0 commands for a defective track or any multitrack commands switching from a known alternate or defective track.	5	No
0 1	6 7	Track condition check Operation incomplete	Switching from alternate track during overflow record processing or switching to a defective track during overflow record processing.	9	No

Byte	Bit	Name	General Description	Action	Logged
0	7	Seek check	Seek incomplete or incorrect physical address when reading home address or count area.	6	Yes
1	1	Invalid track format	Track capacity exceeded.	2	No
1	2	End of cylinder	Cylinder boundary detected during a multitrack operation.	10	No
1 1	2 7	End of cylinder Operation incomplete	Cylinder boundary detected during an overflow operation.	11	No
1	4	No record found	Programming error or expected programming error condition. The search data does not exist on that track.	2	No
1	5	File protected	The Seek command or read/search multitrack operation violated the file mask.	12	No
1 1	5 7	File protected Operation incomplete	A read or write overflow violated the file mask.	13	No
2	3	Environmental data present	Statistical usage/error log information is present.	3	yes

## Recovery Action Table – 3340 and 3344

*Note: Cylinder bytes and the high-order head bytes are obtained from the user, not from the sense bytes. The low-order head byte is obtained from sense byte 6, bits 3 through 7.*

### Action Explanation

- 1 Print console error message.
- 2 Exit with programming error or unusual condition indication.
- 3
  - a. Repeat the operation once.
  - b. If the error condition persists, do action 1.
- 4
  - a. Repeat the operation.
  - b. If the error condition persists after ten retries, do action 1.
- 4A An uncorrectable data check has occurred during a Read Multiple CKD command. The restart chain must orient on the count field prior to the record in error.

Determine the quantity of bytes read (CCW count minus residual count; if data chaining was indicated, the counts of the data-chained Read Multiple CKD CCWs up to the one in error must be accumulated). Using this count and starting with the data pointed to by the Read Multiple CDK (or start of the data chain), scan through main storage and locate the count fields of records successfully read. Obtain the length of each record from its count field. Develop a pointer to the first byte following the last record successfully read (to be used as the data address in the restart CCW).

For Format 4 messages 1, 2, or 3, the field in error will have entered main storage; for message 5, 6, or 7, the field will not have entered main storage.

Restart the operation by executing:

Seek	(same as original, see Note at top)
Set File Mask	(same as original)
Search ID Equal	(CCHHR of last record successfully read as determined by the previous calculations in this recovery action)
TIC *-8	
Read Multiple CKD	Data address as determined above in this action count = residual count, flags are the same as the interrupted CCW. If the record still cannot be read after ten retries, do action 1.)
TIC (ICCW Address)	(indicated CCW address)

- 4B
  - a. Print console error message.
  - b. Repeat the operation once.
  - c. If error condition persists, do action 1.

*Note: Cylinder bytes and the high-order head bytes are obtained from the user, not from the sense bytes. The low-order head byte is obtained from sense byte 6, bits 3 through 7.*

**Action Explanation**

- 5 a. If this is a defective track, do action 5A.  
 b. Use the address of the defective track plus 1 in a Seek command. The defective track address can be found in the ID area of record 0 count area.  
 c. Resume operation after searching to the desired track position.
- 5A a. Use the address of the alternate track in a Seek command. The alternate track address can be found in the ID area of the record 0 area.  
 b. Resume operation after searching to the desired track position.
- 6 a. Issue a Recalibrate command.  
 b. Seek to the original address.  
 c. Do action 4.
- 7 a. Perform the error correction function.  
 b. Examine bit 7 of the file mask. If off, go to step c. If on, indicate that the data has been corrected. (The user is operating in PCI fetch mode and must supply the restart recovery action.)  
 c. Examine the interrupted CCW. If the command is a Read Multiple CKD, do action 7B; otherwise, continue. If the user's chain is not completed, examine the next non-TIC command. If bit 3 is on (count area), go to step d; if off, do action 7A.

If data chaining is indicated in the interrupted CCW, the preceding test must be executed on the first non-TIC after the last CCW in the data chain.  
 d. Continue the user's chain (if appropriate) by executing:

Seek (same as original, see Note at top)  
 Set File Mask (same as original)  
 Read Home Address (skip bit is on)  
 Search ID Equal (CCHHR from sense bytes 8 through 12)  
 TIC \*8  
 TIC (ICCW Address) (indicated CCW address)

- 7A Continue the user's chain by executing:

Seek (same as original, see Note at top)  
 Set File Mask (same as original)  
 Read Home Address (skip bit is on)  
 Search ID Equal (CCHHR from sense bytes 8 through 12)  
 TIC \*8  
 Read Count (skip bit is on)  
 TIC (ICCW Address) (indicated CCW address)

*Note: Cylinder bytes and the high-order head bytes are obtained from the user, not from the sense bytes. The low-order head byte is obtained from sense byte 6, bits 3 through 7.*

**Action Explanation**

- 7B This action is used to restart a Read Multiple CKD data recovery process after a correctable data check has been processed. Rebuild the Read Multiple CKD as follows:
- a. Set the command code to X'5E'.
  - b. The data address is that of the interrupted CCW, plus the count of the CCW, minus the residual count. If data chaining was used with the command, the procedure outlined in the restart CCW 2 section, steps 2 and 4, must be used to account for the actual amount of data transferred.
  - c. The flags (except PCI) are those of the interrupted CCW.
  - d. The count is the residual count. If data chaining was used, the procedure outlined in the restart CCW 2 section, step 2, must be used.

Restart the operation by executing:

Seek	(see Note at top)
Set File Mask	(same as original)
Read Home Address	(skip bit is on)
Search ID Equal	(CCHHR from sense bytes 8 through 12)
TIC *-8	
Read Multiple CKD	(from step a)
TIC (ICCW Address)	(to indicated CCW address if user's chain has not been completed)

- 8
- a. Do the error correction function.
  - b. Examine bit 7 of the file mask (PCI). If off, go to step c. If on, indicate that the data has been corrected. The user is operating in PCI fetch mode and must supply the restart recovery action.
  - c. Increment the seek argument by 1 (see Note at top).
  - d. Build restart CCW 2.
  - e. Complete the interrupted operation and continue the user's chain (if appropriate by executing:

Seek	(argument from step c)
Set File Mask	(same as original)
Set Sector	(argument 0)
Search ID Equal	(record 1)
TIC *-8	
Restart CCW 2	
TIC	(pointer established while building CCW 2 + 8)

If the modified seek argument is not within the user's extent, IOS must supply the correct seek argument before issuing the Seek command. If that is impossible, IOS must do action 2.

*Note: Cylinder bytes and the high-order head bytes are obtained from the user, not from the sense bytes. The low-order head byte is obtained from sense byte 6, bits 3 through 7.*

**Action Explanation**

- 8A
- a. Do the error correction function.
  - b. Examine bit 7 of the file mask (PCI). If off, go to step c. If on, indicate that the data has been corrected. The user is operating in PCI fetch mode and must supply the restart recovery action.
  - c. Use the address of the defective track plus 1 in the Seek command.
  - d. Build restart CCW 2.
  - e. Complete the interrupted operation and continue the user's chain (if appropriate) by executing:

Seek (argument from step c, see Note at top)  
 Set File Mask (same as original)  
 Set Sector (argument 0)  
 Search ID Equal (record 1)  
 TIC \*-8  
 Restart CCW 2  
 TIC (pointer established while constructing restart CCW 2 + 8).

If the modified seek argument is not within the user's extent, IOS must supply the correct seek argument before issuing the Seek command. If that is impossible, IOS must do action 2.

- 9
- a. If this is a defective track, do action 9A.
  - b. Use the address of the defective track plus 1 in a Seek command and use the following CCW chain to resume the operation.

Seek  
 Set File Mask (same as original)  
 Set Sector (argument 0)  
 Search ID Equal (record 1)  
 TIC \*-8  
 Restart CCW 1  
 TIC (ICCW Address) (indicated CCW address)

If the modified seek argument is not within the user's extent, IOS must supply the correct seek argument before issuing the Seek command. If that is impossible, IOS must do action 2.

- 9A
- a. Use the address of the alternate track in a Seek command in the following CCW chain.

Seek  
 Set File Mask (inhibit seeks)  
 Set Sector (argument 0)  
 Search ID Equal (record 1)  
 TIC \*-8  
 Restart CCW 1  
 TIC (ICCW Address) (indicated CCW address)

*Note: Cylinder bytes and the high-order head bytes are obtained from the user, not from the sense bytes. The low-order head byte is obtained from sense byte 6, bits 3 through 7.*



**Action Explanation**

- 10 a. Increment the cylinder address of the user's seek argument by 1.  
Reset the head address.  
b. Continue the operation by executing the following:

Seek	(argument from step a)
Set File Mask	(same as original)
Set Sector	(argument 0)
Read Home Address	(skip bit is on)
TIC (ICCW Address -8)	(indicated CCW address minus 8)

If the modified seek argument is not within the user's extent, IOS must supply the correct seek argument before issuing the Seek command. If that is impossible, IOS must do action 2.

- 11 a. Increment the cylinder address of the user's seek argument by 1.  
Reset the head address.  
b. Build restart CCW 1.  
c. Complete the interrupted operation and continue the user's chain (if appropriate) by executing:

Seek	(argument from step a)
Set File Mask	(same as original)
Set Sector	(argument 0)
Search ID Equal	(record 1)
TIC *.8	
Restart CCW 1	
TIC (ICCW Address)	(indicated CCW address)

If the modified seek argument is not within the user's extent, IOS must supply the correct seek argument before issuing the Seek command. If that is impossible, IOS must do action 2.

- 12 a. Determine if the interrupted command is a seek. If it is, go to step b. If not, do action 12A.  
b. Complete the interrupted operation and continue the user's chain (if appropriate) by executing:

Seek	(same as original, see Note at top)
Set File Mask	(same as original)
Set Sector	(argument 0)
Read Home Address	(skip bit is on)
TIC (ICCW Address)	(indicated CCW address)

If the modified seek argument is not within the user's extent, IOS must supply the correct seek argument before issuing the Seek command. If that is impossible, IOS must do action 2.

*Note: Cylinder bytes and the high-order head bytes are obtained from the user, not from the sense bytes. The low-order head byte is obtained from sense byte 6, bits 3 through 7.*

**Action Explanation**

- 12A a. This is a multitrack operation. Increment the user's seek argument by 1 (see Note at top).  
b. Complete the interrupted operation and continue the user's chain (if appropriate) by executing:

Seek (argument from step a)  
Set File Mask (same as original)  
Set Sector (argument 0)  
Read Home Address (skip bit is on)  
TIC (ICCW Address -8) (indicated CCW address minus 8)

If the modified seek argument is not within the user's extent, IOS must supply the correct seek argument before issuing the Seek command. If that is impossible, IOS must do action 2.

- 13 a. Increment the user's seek argument by 1.  
b. Build the restart CCW 1.  
c. Complete the interrupted operation and continue the user's chain (if appropriate) by executing:

Seek (argument from step a)  
Set File Mask (same as original)  
Set Sector (argument 0)  
Search ID Equal (record 1)  
TIC \*-8  
Restart CCW 1  
TIC (ICCW Address) (indicated CCW address)

If the modified seek argument is not within the user's extent, IOS must supply the correct seek argument before issuing the Seek command. If that is impossible, IOS must do action 2.

## Chapter 11. Sense Bytes – 3375

Sense information for the 3375 (24 bytes) identifies the conditions that caused the last unit check status to be generated. The sense information also provides secondary information for system error recovery and for diagnosing and isolating storage director and device malfunctions.

### Sense Byte 0

#### Bit 0 - Command Reject

Bit 0 is set by:

- An invalid command code
- An invalid command sequence
- An invalid or incomplete argument transferred by a control command
- A track formatted without a home address
- Issuing a write command with the R/W – Read Only switch in the Read Only position
- Attempting a format write command (other than Write Home Address or Write RO) on a defective track
- Issuing a write command that violates the file mask
- A record zero count field of a defective track that points to itself or an alternate track (replacing a defective track) that points to itself

If the speed matching buffer for 3375 feature is installed in the 3880, command reject is also set if:

- A command has been received in the domain of a Locate Record command that does not conform with the operation parameter. (See the description of the Locate Record command for additional information.)
- The operation specified by a Locate Record command is inhibited by the file mask.

### **Bit 1 - Intervention Required**

Bit 1 is set by:

- Addressing a drive that is not attached to the system
- Addressing a drive that is not ready
- Addressing a drive that is in CE mode.

### **Bit 2 - Bus Out Parity**

Bit 2 is set when a parity error is detected during transfer of a command or data from the channel to the 3880.

### **Bit 3 - Equipment Check**

Bit 3 is set when an unusual hardware condition occurs in the channel, storage director, controller, or drive. The condition is further defined in sense bytes 7 through 23.

### **Bit 4 - Data Check**

Bit 4 is set when the storage director detects a data error in the information received from the drive. If byte 2, bit 1 (correctable) is also set, the data error is correctable and bytes 15 through 23 (Format 5) provide correction information. Sense byte 7 defines the specific nature of the condition.

### **Bit 5 - Overrun**

Bit 5 is set when the storage director does not receive a response to a data request within a specified period of time. On the speed matching buffer feature, this error can be caused by defining incorrect define extent parameters.

Detection of an overrun may cause requests for data from the channel to be terminated. When writing, the remaining portion of the record area is padded with a replicated data byte.

All data overrun conditions are retried by the storage director except those that occur during a format write operation, or those that occur after the first record processed by a Read Multiple Count, Key, and Data command.

The storage director presents an overrun only if the condition occurs more than ten times in the same CCW chain, or if the overrun occurs during one of the above operations not retried by the storage director.

Command overruns are also retried by the storage director and do not cause an overrun to be presented.

## **Bit 6**

Bit 6 is not used. It is set to zero.

## **Bit 7**

Bit 7 is not used. It is set to zero.

## **Sense Byte 1**

### **Bit 0 - Permanent Error**

Bit 0 is set when error recovery procedures that were initiated by a storage director have been exhausted and were unsuccessful, or when retry was not possible or desirable.

The bit overrides any other bit settings and indicates that system error recovery procedures are not required.

### **Bit 1 - Invalid Track Format**

Bit 1 is set when:

- An attempt is made to write data exceeding track capacity
- An index point is detected in the gap that precedes a key or data field
- A previous operation attempted to write data exceeding the track capacity; this operation resulted in a record written into index. This record was detected while attempting to execute a read, search, or write command. As long as this record remains on the track, invalid track format may be presented while attempting to locate a record successfully written on the track. However, a Search ID will be able to execute on any count field successfully written on the track without presenting invalid track format.

### **Bit 2 - End of Cylinder**

Bit 2 is set when a multitrack read or search operation continues past the end of the cylinder boundary.

### **Bit 3 - Message to Operator**

Bit 3 works with either byte 0, bit 3 (equipment check) or byte 2, bit 3 (environmental data present). When byte 1, bit 3 is set along with byte 0, bit 3, the two bits indicate a permanent failure of the alternate storage director. These bits send a Format 3 message to the operator console. When byte 1, bit 3 is set along with byte 2, bit 3, a Format 0 message indicating the error path is sent to the operator console.

Bit 3 is set when there is a permanent failure in the other storage director in the same 3880 or a state save operation in the reporting storage director.

Byte 0, bit 3 (equipment check) is also set. A message will be sent to the operator console.

This bit is also set when the storage director has completed sense data logging of a particular error type. Format 0 message 1 or 2 is indicated in byte 7. Byte 2, bit 3 (environmental data present) is also set.

#### **Bit 4 - No Record Found**

Bit 4 is set when two index points have been detected in the same CCW chain without an intervening read operation in the home address or data area, or without an intervening write, sense, or control command.

If the speed matching buffer for 3375 feature is installed in the 3880, this bit is also set if the proper record is not found during execution of a Locate Record command.

#### **Bit 5 - File Protected**

Bit 5 is set to indicate that a seek command or read or search multitrack operation violated the file mask.

If the speed matching buffer for 3375 feature is installed in the 3880, this bit is also set if:

- An attempt was made to access or operate on a track outside the boundaries established by a Define Extent command.
- A Locate Record operation attempts to exceed the extent boundaries.

#### **Bit 6 - Write Inhibited**

Bit 6 is set when a write command is received for a drive that has its R/W – Read Only switch in the Read Only position. Byte 0, bit 0 (command reject) is also set.

#### **Bit 7**

Bit 7 is not used. It is set to zero.

### **Sense Byte 2**

#### **Bit 0**

Bit 0 is not used. It is set to zero.

### **Bit 1 - Correctable**

Bit 1 is set when the data check condition indicated by byte 0, bit 4 (data check) is correctable.

### **Bit 2 - First Logged Error**

Bit 2 is set to indicate that the error rate for temporary data or seek checks has been exceeded and logging mode has been set for the device.

### **Bit 3 - Environmental Data Present**

Bit 3 is set to indicate that bytes 8 through 23 contain usage or error statistics, or error log information. Byte 7 indicates the format for bytes 8 through 23.

Bit 3 is set with Format 6 when a usage or error counter overflows or when a Read and Reset Buffered Log command is executed. It is set with formats 1, 4, and 5 when the storage director is in force error log mode.

### **Bit 4 - Intent Violation**

If the speed matching buffer for 3375 feature is installed in the 3880, bit 4 is used to indicate an intent violation. This bit is set if one of the following occurs during execution of a data transfer command in the domain of a Locate Record command.

- An update write operation is attempted on a record whose size differs from the record size parameters.
- An update write is attempted on R0 and the data area is not 8 bytes in length.

This bit is also set if a record is not detected after home address during execution of a Write CKD Next Track, Write Update Data, or Write Update Key and Data command.

Bit 4 is not used if the speed matching buffer for 3375 feature is not installed in the 3880.

### **Bit 5 - Imprecise Ending**

Bit 5 is used to indicate an imprecise ending condition. This bit is set if an abnormal channel program end occurs and the status presented is for a previously executed command. It indicates that the indicated CCW command address is not in sync with the transfer of data from the storage director to the disk.

Bit 5 is not used if the speed matching buffer for 3375 feature is not installed in the 3880.

## Bits 6 and 7

Bits 6 and 7 are not used. They are set to zero.

## Sense Byte 3

For formats 1, 2, and 6, byte 3 contains the controller ID. This byte is not used for formats 0, 3, 4, and 5 unless the speed matching buffer for 3375 feature is installed in the 3880.

If the speed matching buffer for 3375 feature is installed in the 3880, the value in this byte (formats 0, 3, 4, and 5 only) indicates the number of records that remain to be processed in the domain of a Locate Record command after the channel program ended with unit check status and imprecise ending sense data.

## Sense Byte 4

### Bit 0

Bit 0 is set when a Model D1 is installed.

### Bits 1 and 2

Bits 1 and 2 are not used. They are set to zero.

### Bits 3 and 4 - Controller Address

Bits 3 and 4 indicate the controller address.

Bits 3 and 4 =	00	Controller Address =	0
	01		1
	10		2
	11		3

### Bits 5 through 7 - Device Address

Bits 5 through 7 indicate the device address.

Bits 5-7 =	Actuator Address	Actuator Module
000	0	1
001	1	1
010	2	2
011	3	2
100	4	3
101	5	3
110	6	4
111	7	4



## Sense Byte 5

### Bits 0 through 7 - Cylinder-Low Address

Bits 0 through 7 identify the low-order cylinder address of the most recent access position.

With sense Format 3 (microcode detected), byte 5 indicates the high-order byte of the instruction address register.

With sense Format 6, byte 5 indicates the number of diskette checks after an initial microcode load (IML) or a storage director-to-storage director communication failure.

Bit 0 = Communication failure during an IML	Bits 2-4 = Diskette check (seek errors)
Bit 1 = Not used	Bits 5-7 = Diskette check (read errors)

## Sense Byte 6

### Bits 0 through 7 - Cylinder-High and Head

Bits 0 through 7 identify the high-order cylinder and head address of the most recent access position.

Cylinder Address	Head Address
Bit 0 = 512	Bit 4 = 8
Bit 1 = 256	Bit 5 = 4
Bit 2 = 0	Bit 6 = 2
Bit 3 = 0	Bit 7 = 1

With sense Format 3 (microcode detected), byte 6 indicates the low-order byte of the instruction address register.

With sense Format 6, byte 6 contains the storage director ID.

## Sense Byte 7

### Bits 0 through 3 - Format

Bits 0 through 3 specify the format of sense bytes 8 through 23 as follows:

- 0000 = Format 0 – program or system checks
- 0001 = Format 1 – device equipment checks (CE information)
- 0010 = Format 2 – storage director equipment checks (CE information)
- 0011 = Format 3 – storage director control checks (CE information)
- 0100 = Format 4 – data checks without displacement information
- 0101 = Format 5 – data checks with displacement information (Format 5  
also may be presented on errors which are not ECC  
correctable, but which require restart displacement  
information.)
- 0110 = Format 6 – usage statistics/overrun errors

### Bits 4 through 7 - Message

Bits 4 through 7 describe the specific nature of the error conditions for each of the above formats. The message table that accompanies the format descriptions specifies the function of the message bits for the format.

## Format 0 – Program or System Check

Format 0 is used when sense bytes 0 through 7 completely describe the error or unusual condition caused by a program or system error.

### Bytes 8 through 19

Bytes 8 through 19 are not used. They are set to zero.

### Byte 20

Byte 20 contains the controller physical address.

### Byte 21

Byte 21 contains the storage director ID.

### Bytes 22 and 23

Bytes 22 and 23 contain the symptom code.

## Message Table – Format 0 (Byte 1, Bit 3 = 0)

Sense Byte 7, Bits 4-7 =	Message Code	Message
0000	0	No message. No additional information is required.
0001	1	Invalid command.
0010	2	Invalid command sequence.
0011	3	The CCW count was less than required for the command.
0100	4	An invalid data argument was used for the command.
0101	5	A diagnostic command was issued when not permitted by the file mask.
0110	6	Retry status was presented and the channel did not indicate chaining.
0111	7	The command code of the CCW returned after a retry sequence did not match the command for which the retry was signaled.
1000-1010	8-A	Not used.
1011	B	The alternate track pointer of a defective track pointed to itself.
1100-1111	C-F	Not used.

## Message Table – Format 0 (Byte 1, Bit 3 = 1)

Sense Byte 7, Bits 4-7 =	Message Code	Message
0000	0	No message. No additional information required.
0001	1	Sense data logged for device.
0010	2	Sense data logged for controller.
0011-1111	3-F	Not used.

## Format 1 – Device Equipment Check

Format 1 is generated when:

- A device, device interface, or a controller equipment check is detected. Byte 0, bit 3 (equipment check) is also set.
- A permanent device seek check is detected. Byte 0, bit 3 (equipment check) and byte 1, bit 0 (permanent error) are also set.
- Error log information is off-loaded after a successful retried seek that occurred during error logging. Byte 2, bit 3 (environmental data present) is also set. The message bits in sense byte 7 indicate a seek error.
- Byte 11, bit 4 (on line) is off. Byte 0, bit 1 is also set.

### Byte 8 - CTL-I Tag Bus

Byte 8 contains the CTL-I tag bus value at the time the error was detected. This byte is not valid if it is zero. For message code A and if byte 11, bit 2 (drive check) is 0, byte 8 contains the high-order physical cylinder address of the track just read.

### Byte 9 - CTL-I Bus Out

For message codes 2, 3, 4, B, C, D, F, and A if byte 11, bit 2 = 1, byte 9 identifies the contents of the CTL-I bus out at the time the error was detected. For message codes 1, 5, and 9, byte 9 contains the expected drive status or data. For message code A and if byte 11, bit 2 (drive check) is 0, byte 9 contains the low-order cylinder address of the record just read.

### Byte 10 - CTL-I Bus In

Byte 10 contains the CTL-I bus in value at the time the error was detected. For message code A and if byte 11, bit 2 (drive check) is 0, byte 10 is zero.

Bit 0 = Data read back from the drive does not compare (Bits 5-7 = 001, 101, 011, or 100)	Bits 5-7 = 000 - No busy condition = 001 - Difference counter high = 010 - CAR = 011 - High order CAR and HAR = 100 - Difference counter low = 101 - Drive check during offset
Bit 1 = Sync out timing error	
Bit 2 = Failed to reset head offset	
Bit 3 = Device error (bits 5-7 = 000 or 101)	
Bit 4 = Invalid control byte	

### Byte 11 - Drive Status

Bit 0 = Controller check	Bit 4 = On line
Bit 1 = Device interface check	Bit 5 = HDA attention
Bit 2 = Drive check	Bit 6 = Busy – not sector compare
Bit 3 = R/W check	Bit 7 = Seek, offset, or pad complete or search sector

## Byte 12 - Sense Interface

Bits 0-5 = Not used  
Bit 6 = Device bus out parity check  
Bit 7 = Device tag bus parity check

## Byte 13

When byte 11, bit 0 is off:	When byte 11, bit 0 and 4 are on:
Bit 0 = Write mode or standby check	Bit 0 = Drive selected 0
Bit 1 = Capable/enable check	Bit 1 = Drive selected 1
Bit 2 = Write overrun	Bit 2 = Drive selected 2
Bit 3 = Index check	Bit 3 = Drive selected 3
Bit 4 = Control check	Bit 4 = Drive selected 4
Bit 5 = Select error	Bit 5 = Drive selected 5
Bit 6 = HDA write check	Bit 6 = Drive selected 6
Bit 7 = Decode check	Bit 7 = Drive selected 7

## Byte 14

When byte 11, bit 0 is off:	When byte 11, bit 0 is on:
Bit 0 = Write inhibit	Bit 0 = Not used
Bit 1 = Not used	Bit 1 = Not used
Bit 2 = Sector compare check	Bit 2 = Not used
Bit 3 = Write select verify	Bit 3 = Not used
Bit 4 = Write op OK	Bit 4 = Microcontroller check 1
Bit 5 = No select error	Bit 5 = Microcontroller check 2
Bit 6 = HDA read check	Bit 6 = Not used
Bit 7 = Transition detect check	Bit 7 = PROM store check

## Byte 15

When byte 11, bit 0 is off:	When byte 11, bit 0 is on:
Bit 0 = HDA sequence latch 0	Bit 0 = CTL=I bus out parity check
Bit 1 = HDA sequence latch 1	Bit 1 = CTL=I tag bus parity check
Bit 2 = HDA sequence latch 2	Bit 2 = Funnel 0/1 parity check
Bit 3 = CE drive motor switch on	Bit 3 = Multiple spindle select error
Bit 4 = Selected PLL good	Bit 4 = Device bus in parity check
Bit 5 = DC voltage good	Bit 5 = Selected interface (0 = A, 1 = B)
Bit 6 = Always 1	Bit 6 = Transfer check
Bit 7 = Unselected PLL good	Bit 7 = MD bus in parity check

## Byte 16

When byte 11, bit 0 is off:	When byte 11, bit 0 is on:
Bit 0 = Access timeout	Bit 0 = Control register 3, 4, or 5 parity check
Bit 1 = Overshoot check	Bit 1 = Reorient counter parity check
Bit 2 = Servo off track	Bit 2 = Any DEVI register parity check

Bit 3 = Invalid location  
Bit 4 = Sequence latch 8  
Bit 5 = Sequence latch 4  
Bit 6 = Sequence latch 2  
Bit 7 = Sequence latch 1

Bit 3 = Buffer or control register 16 or 17 parity check  
Bit 4 = Not used  
Bit 5 = Error alert  
Bit 6 = Not used  
Bit 7 = Forced error alert

### Byte 17

When byte 11, bit 0 is off:

Bit 0 = Guardband latch  
Bit 1 = Guardband 2 ID  
Bit 2 = Track crossing latch  
Bit 3 = Velocity polarity latch  
Bit 4 = Even track latch  
Bit 5 = Fine position  
Bit 6 = End accelerate  
Bit 7 = End decelerate

When byte 11, bit 0 is on:

Bit 0 = SERDES data funnel parity check  
Bit 1 = Counter parity check  
Bit 2 = ECC hardware check  
Bit 3 = VFO not in sync  
Bit 4 = SERDES error  
Bit 5 = SERDES data parity check  
Bit 6 = Write data check  
Bit 7 = Sync-out timing error

### Byte 18

When byte 11, bit 0 is off:

Bit 0 = Direction bit (1 = in)  
Bit 1 = Difference count 512  
Bit 2 = Difference count 256  
Bit 3 = Not used  
Bit 4 = Not used  
Bit 5 = Not used  
Bit 6 = Not used  
Bit 7 = Not used

When byte 11, bit 0 is on:

Bit 0 = Not used  
Bit 1 = Not used  
Bit 2 = Not used  
Bit 3 = Not used  
Bit 4 = Not used  
Bit 5 = Not used  
Bit 6 = Microcode detected errors  
Bit 7 = Hardware detected errors

### Byte 19

When byte 11, bit 0 is off:

Bit 0 = Difference/bit 128  
Bit 1 = Difference/offset 64  
Bit 2 = Difference/offset 32  
Bit 3 = Difference/offset 16  
Bit 4 = Difference/offset 8  
Bit 5 = Difference/offset 4  
Bit 6 = Difference/offset 2

When byte 11, bit 0 is on and sense byte 7 = X'12'. Bits 0-2 are not used.

Bits 3 through 7 indicate the following error conditions:  
0000 = Not used  
0001 = Tag Valid indication missing on a read or write operation  
0010 = Normal End or Check End indication missing on a read, write, or ECC operation  
0011 = Tag Valid, Normal End, or Check End indication missing in response to an operation other than a read or write  
0100 = Timed out waiting for index  
0101 = String switch short busy timed out

Bit 7 = Difference/offset 1

0110 = Address assigned to either more than one controller or no controller  
0111 = Preselection check  
1000 = Not used  
1001 = Repetitive command overruns occurred  
1010 = Drive busy or storage director initiated selection  
1011 = Busy missing after seek start issued  
1100 = Invalid Check End  
1101 = Not used  
1110 = Preselection bus check  
1111 = Unresetable interrupt  
0001 0000 = HDA attention detected during device reconnection for a disconnected command chain  
0001 0001 = Time out on re-orient tag  
0001 0010 = Time out during retry  
0001 0011 = Reorientation tag reached index  
0001 0100 = Overrun on space tag during retry

When byte 11, bit 0 is on, and Format 1, message 2 is not set, byte 19 is not used. If byte 11, bit 0 is off and Format 1, message 2 is set, bits 0-7 are used for microcode detected errors.

## Byte 20

When byte 11, bit 0 is off:

Bit 0 = Target 128  
Bit 1 = Target 64  
Bit 2 = Target 32  
Bit 3 = Target 16  
Bit 4 = Target 8  
Bit 5 = Target 4  
Bit 6 = Target 2  
Bit 7 = Target 1

When byte 11, bit 0 is on:

If byte 18, bit 6 is on, bits 0 through 7 contain the microcontroller error code. If byte 18, bit 6 is off, bits 0 through 7 are not used.

## Byte 21

Byte 21 contains the storage director ID.



## Bytes 22 and 23

Bytes 22 and 23 contain the symptom code.

### Message Table – Format 1

<b>Sense Byte 7, Bits 4-7 =</b>	<b>Message Code</b>	<b>Message</b>
0000	0	Equipment check or intervention required.
0001	1	Transmit target error.
0010	2	Microcode detected error.
0011	3	Locate data error.
0100	4	Sync-out timing error.
0101	5	Unexpected drive status at initial selection.
0110	6	Not used.
0111	7	Not used.
1000	8	Not used.
1001	9	Unexpected drive status during retry or Read IPL.
1010	A	Seek error.
1011	B	Seek incomplete on retry.
1100	C	No interrupt from drive.
1101	D	Microcontroller check recovered on other interface.
1110	E	Not used.
1111	F	Microcontroller check.

## Format 2 – Storage Director Equipment Check

Format 2 is generated to provide sense information when the microcode detects a storage director error condition.

<b>Byte 8</b>	Contents of the transfer complete status (XCS) register.
<b>Byte 9</b>	Contents of the transfer error status (XES) register.
<b>Byte 10</b>	Contents of the check (CHK) register.
<b>Byte 11</b>	Contents of the channel transfer complete (CXC) register.
<b>Byte 12</b>	Contents of the channel control 2 (CC2) register.
<b>Byte 13</b>	Contents of the device bus out (DBO) register.
<b>Byte 14</b>	Contents of the device bus in (DBI) register.
<b>Byte 15</b>	Contents of the device tag out (DTO) register.
<b>Byte 16</b>	Contents of the device tag gate (DTG) register.
<b>Byte 17</b>	Contents of the device tag in (DTI) register.
<b>Byte 18</b>	Contents of the channel status 2 (CS2) register.
<b>Byte 19</b>	Contents of TFR register (3375 speed matching buffer).
<b>Byte 20</b>	Indicates microcode-detected storage director errors. Bits 0 through 3 are not used. If bits 4 through 7 equal 0001, the device attempted to end data transfer prematurely.
<b>Byte 21</b>	Storage director ID.
<b>Bytes 22 and 23</b>	Symptom code.

## Message Table – Format 2

<b>Sense Byte 7, Bits 4-7 =</b>	<b>Message Code</b>	<b>Message</b>
0000-0111	0-7	Not used.
1000	8	No message. No additional information required.
1001	9	Selective reset occurred while the drive was selected.
1010	A	Failed to latch the First Sync In line.
1011	B	Not used.
1100	C	Channel failed to respond to a selective reset request.
1101 and 1110	D and E	Reserved.
1111	F	Storage director microcode detected error.

### Format 3 – Storage Director Control Check (Hardware Detected)

Format 3 is generated to provide sense information for a failing storage director that requires a reset procedure for recovery.

<b>Byte 8</b>	Contents of field-replaceable unit (FRU) register 2.
<b>Byte 9</b>	Contents of check register 1.
<b>Byte 10</b>	Contents of check register 2.
<b>Byte 11</b>	Contents of check register 3.
<b>Byte 12</b>	Not used.
<b>Byte 13</b>	Not used.
<b>Byte 14</b>	Not used.
<b>Byte 15</b>	Contents of FRU register 3.
<b>Byte 16</b>	Contents of FRU register 4.
<b>Byte 17</b>	Not used.
<b>Byte 18</b>	Not used.
<b>Byte 19</b>	Not used.
<b>Byte 20</b>	Not used.
<b>Byte 21</b>	Storage director ID.
<b>Bytes 22 and 23</b>	Symptom code.

### Message Table – Format 3

<b>Sense Byte 7, Bits 4-7 =</b>	<b>Message Code</b>	<b>Message</b>
0000-0111	0-7	Not used.
1000	8	No message. No additional information required.
1001-1111	9-F	Not used.

### Format 3 – Storage Director Control Check (Microcode Detected)

<b>Byte 8</b>	Not used.
<b>Byte 9</b>	Contents of the transfer error status (XES) register.
<b>Byte 10</b>	Contents of the check (CHK) register.
<b>Byte 11</b>	Contents of the condition register 0 (CRO).
<b>Byte 12</b>	Contents of the channel status 2 (CS2) register.
<b>Byte 13</b>	Contents of the channel control 1 (CC1) register.
<b>Byte 14</b>	Contents of the channel control 2 (CC2) register.
<b>Byte 15</b>	Contents of the channel status 1 (CS1) register.
<b>Byte 16</b>	Contents of the channel status 3 (CS3) register.
<b>Byte 17</b>	Contents of the channel transfer control (CXC) register.
<b>Byte 18</b>	Contents of the channel bus out (CBO) register.
<b>Byte 19</b>	Contents of the channel bus in (CBI) register.
<b>Byte 20</b>	Contains the timeout message when sense bytes 22 and 23 contain a symptom code of 3F2X. Otherwise, this byte is the interrupt level.
<b>Byte 21</b>	Storage director ID.
<b>Bytes 22 and 23</b>	Symptom code.

### Message Table – Format 3

<b>Sense Byte 7, Bits 4-7 =</b>	<b>Message Code</b>	<b>Message</b>
0000-0111	0-7	Not used.
1000	8	Clock stopped check 1.
1001	9	Channel check 1 or storage director timeout.
1010	A	Trace table saved in this storage director.
1011-1111	B-F	Not used.

## **Format 4 – Data Check Without Displacement Information**

Format 4 is generated when:

- Errors that were not correctable by the ECC are detected after retry has been unsuccessful (permanent error and data check are also set) or retry is inhibited by the file mask.
- Error log information is off-loaded after an ECC uncorrectable error occurred during error logging. The information was recovered through use of command retry. Byte 2, bit 3 (environmental data present) is also set.
- Data checks are detected while processing a Read Multiple CKD command.
- ECC uncorrectable errors were detected in the count, key, or data field. Byte 7 identifies the field.

### **Bytes 8 through 12 - Record Identification**

Bytes 8 through 12 contain the record ID obtained from the count field of the record in which the error occurred. These bytes are unreliable if the message code in byte 7 is 0, 1, 4, or 5. Byte 12 is zero if the message code is 0 or 4. Byte 12 is unreliable after a Space Count command.

### **Byte 13 - Sector Number**

Byte 13 contains the sector number of the record in error.

### **Byte 14 - Controller Physical Address**

Byte 14 contains the controller physical address.

### **Byte 15 - Access Offset**

For permanent errors, this byte contains the offset last used for retrying a data check. If the error was not permanent, this byte provides the offset required to recover from the error.

### **Bytes 16 through 20**

Bytes 16 through 20 are not used.

### **Byte 21**

Byte 21 contains the storage director ID.

## Bytes 22 and 23

Bytes 22 and 23 contain the symptom code.

### Message Table – Format 4

<b>Sense Byte 7, Bits 4-7 =</b>	<b>Message Code</b>	<b>Message</b>
0000	0	An error occurred in the home address area and could not be corrected by the ECC.
0001	1	An error occurred in the count area and could not be corrected by the ECC.
0010	2	An error occurred in the key area and could not be corrected by the ECC.
0011	3	An error occurred in the data area and could not be corrected by the ECC.
0100	4	Data synchronization on the home address area was unsuccessful.
0101	5	Data synchronization on the count area was unsuccessful.
0110	6	Data synchronization on the key area was unsuccessful.
0111	7	Data synchronization on the data area was unsuccessful.
1000-1111	8-F	Not used.

## **Format 5 – Data Check With Displacement Information**

Format 5 is generated when:

- Data checks that are correctable by the ECC are detected in the count, key, or data areas of a record.
- Data checks in data areas that are not correctable by the ECC were successfully retried but the file mask specified PCI fetch mode.
- Error log information is off-loaded after an ECC correctable error occurred during error logging. (Byte 2, bit 3 [environmental data present] is also set.)
- Data checks that are correctable by the ECC are detected in the count or key areas of a record, but retry is inhibited by the file mask. Messages 1 or 2 may be presented with data check and correctable sense bits set. No ERP action is required. If the ERPs are invoked, they will not operate properly.

### **Bytes 8 through 12 - Count ID**

Bytes 8 through 12 contain the record ID obtained from the count field of the record in which the error occurred. These bytes are unreliable if the message code in byte 7 is 0, 1, 4, or 5. Byte 12 is unreliable after a Space Count command.

### **Byte 13 - Sector Number**

Byte 13 contains the sector number of the record in error.

### **Byte 14 - Controller Physical Address**

Byte 14 contains the controller physical address.

### **Bytes 15 through 17 - Restart Displacement**

If byte 2, bit 3 = 0, bytes 15 through 17 contain the restart displacement. If byte 2, bit 3 = 1, byte 15 contains the head offset, byte 16 contains the storage director ID, and byte 17 is not used.

### **Bytes 18 and 19 - Error Displacement**

Bytes 18 and 19 contain the error displacement.

### **Bytes 20 and 21 - Error Pattern**

Bytes 20 and 21 contain the error pattern.



## Bytes 22 and 23

Bytes 22 and 23 are not used.

## Message Table – Format 5

<b>Sense Byte 7, Bits 4-7 =</b>	<b>Message Code</b>	<b>Message</b>
0000	0	Home address data check – correctable.
0001	1	Count area data check – correctable.
0010	2	Key area data check – correctable.
0011	3	Data area data check – correctable.
0100-1111	4-F	Not used.

## **Format 6 – Usage Statistics/Overrun Errors**

Format 6 is generated when:

- A Read and Reset Buffered Log command is executed.
- Usage/error statistics require off-loading due to counter overflow.

### **Bytes 8 through 11 - Bytes Read or Searched**

Bytes 8 through 11 contain an accumulated count of the number of bytes processed by the storage director during read and search operations (only the key and data field bytes are counted). Bytes processed during retry operations are not counted.

### **Bytes 12 through 15**

Bytes 12 through 15 are not used.

### **Bytes 16 and 17 - Number of Seeks**

Bytes 16 and 17 contain the number of access moves processed by the storage director.

### **Byte 18**

Byte 18 is not used.

### **Byte 19 - Data Overruns**

Byte 19 contains the number of data overruns that occurred on the channel specified in the message table of byte 7.

### **Byte 20 - Command Overruns**

Byte 20 contains the number of command overruns that occurred on the channel specified in the message table of byte 7.

### **Byte 21**

Storage director ID.

### **Bytes 22 and 23**

Bytes 22 and 23 are not used.

## Message Table – Format 6

<b>Sense Byte 7, Bits 4-7 =</b>	<b>Message Code</b>	<b>Message</b>
0000-0111	0-7	Not used.
1000	8	Channel A overruns (bytes 19 and 20).
1001	9	Channel B overruns (bytes 19 and 20).
1010	A	Channel C overruns (bytes 19 and 20).
1011	B	Channel D overruns (bytes 19 and 20).
1100-1111	C-F	Not used.

## Error Condition Table – 3375

Byte	Bit	Name	General Description	Action	Logged
0	0	Command reject	Programming error.	2	No
0	1	Intervention required	Drive offline.	3	No
0	2	Bus out parity	Bus out parity error.	3	Yes
0	3	Equipment check	Equipment malfunction.	4	Yes
0 1	3 0	Equipment check Permanent error	Equipment malfunction Storage director retry exhausted or undesirable.	1	Yes
0 1	3 3	Equipment check Message to operator	Permanent equipment malfunction of the alternate storage director or a state save operation in reporting storage director.	4A	Yes
0	4	Data check	Data check not correctable with a Read Multiple CKD command.	4	No
0 1	4 0	Data check Permanent error	Uncorrectable data check, storage control retry exhausted. Imprecise ending is possible if within the Locate Record command domain.	1	Yes
0 2	4 1	Data check Correctable	Correctable data check in the data area.	5	No
0	5	Overrun	Service overrun on a format write or a Read Multiple CKD, or storage control retry exhausted.	4	Yes
1	1	Invalid track format	Track capacity exceeded.	2	No
1	2	End of cylinder	Cylinder boundary detected during a multitrack operation, or during a multitrack operation not within the Locate Record command domain.	6	No
1	4	No record found	Record not found in the command sequence.	2	No
1	5	File protected	The Seek command or read and/or search multitrack operation violated the file mask or not in the Locate Record command domain.	7	No
2	3	Environmental data present	Statistical usage/error log information is present.	3	Yes
1 2	3 3	Message to operator Environmental data present	Exit from soft error log mode.	4A	No

Byte	Bit	Name	General Description	Action	Logged
0 1	0 6	Command reject Write Inhibited	Write command received with the R/W – Read-Only switch in the Read-Only position.	1	No
0 1 2	3 0 5	Equipment check Permanent error Imprecise ending	Equipment malfunction and internal retry exhausted. Imprecise ending possible within Locate Record domain.	1	Yes
1 2	1 5	Invalid track format Imprecise ending	Track capacity exceeded.	2	No
1 2	4 5	No record found Imprecise ending	Write CKD Next Track, Write Update Key and Data and no record after home address. Imprecise ending or record not found during execution of a Locate Record.	2	No
0 2	3 5	Equipment check Imprecise ending	Equipment malfunction and imprecise ending possible within Locate Record domain.	4	Yes
1 2	5 5	File protected Imprecise ending	A Locate Record, seek, or multitrack operation has exceeded the boundaries set by a previously executed Define Extent. Imprecise ending is possible if it occurred within the Locate Record domain.	7	No
2 2	4 5	Intent violation Imprecise ending	An update write operation in the domain of a Locate Record has detected a record size that differs from the record size parameter, or an update write of R0 data field under Write Track has been attempted on a field not equal to eight bytes.	2	No

## Recovery Action Table – 3375

Action	Explanation														
1	Print console error message.														
2	Exit with programming error or unusual condition indication.														
3	a. Repeat the operation once. b. If the error condition persists, do action 1.														
4	a. Repeat the operation. b. If the error condition persists after ten retries, do action 1.														
4A	a. Print the console message requesting CE notification. b. Repeat the operation once. c. If the error condition persists, do action 1.														
5	a. Do the error correction function. b. Examine bit 7 of the file mask. If off, go to step c. If on, indicate that the data has been corrected. The user is operating in PCI fetch mode and must supply the restart recovery action. c. Examine the interrupted CCW (indicated CCW address minus 8). If it is a Read Multiple CKD X'51' do action 5B; otherwise, continue. If the user's chain is not complete, examine the next non-TIC command in the chain. If the CCW is a Write Special CKD, Read Sector, Space Count, or if bit 3 of the CCW 1, go to step d. Otherwise, do action 5A. d. Continue the user's chain by executing: <table border="0" style="margin-left: 2em;"> <tr> <td>Seek</td> <td>(see Note below)</td> </tr> <tr> <td>Set File Mask</td> <td>(same as original)</td> </tr> <tr> <td>Read Home Address</td> <td>(skip bit on)</td> </tr> <tr> <td>Search ID Equal</td> <td>(CCHHR from sense bytes 8 through 12)</td> </tr> <tr> <td>TIC *-8</td> <td></td> </tr> <tr> <td>TIC (ICCW Address)</td> <td>(indicated CCW address)</td> </tr> </table>	Seek	(see Note below)	Set File Mask	(same as original)	Read Home Address	(skip bit on)	Search ID Equal	(CCHHR from sense bytes 8 through 12)	TIC *-8		TIC (ICCW Address)	(indicated CCW address)		
Seek	(see Note below)														
Set File Mask	(same as original)														
Read Home Address	(skip bit on)														
Search ID Equal	(CCHHR from sense bytes 8 through 12)														
TIC *-8															
TIC (ICCW Address)	(indicated CCW address)														
5A	If a Define Extent command was executed, do action 5, step e. Otherwise, continue the user's chain by executing: <table border="0" style="margin-left: 2em;"> <tr> <td>Seek</td> <td>(see Note below)</td> </tr> <tr> <td>Set File Mask</td> <td>(same as original)</td> </tr> <tr> <td>Read Home Address</td> <td>(skip bit on)</td> </tr> <tr> <td>Search ID Equal</td> <td>(CCHHR from sense bytes 8 through 12)</td> </tr> <tr> <td>TIC *-8</td> <td></td> </tr> <tr> <td>Read Count</td> <td>(skip bit on)</td> </tr> <tr> <td>TIC (ICCW Address)</td> <td>(indicated CCW address)</td> </tr> </table>	Seek	(see Note below)	Set File Mask	(same as original)	Read Home Address	(skip bit on)	Search ID Equal	(CCHHR from sense bytes 8 through 12)	TIC *-8		Read Count	(skip bit on)	TIC (ICCW Address)	(indicated CCW address)
Seek	(see Note below)														
Set File Mask	(same as original)														
Read Home Address	(skip bit on)														
Search ID Equal	(CCHHR from sense bytes 8 through 12)														
TIC *-8															
Read Count	(skip bit on)														
TIC (ICCW Address)	(indicated CCW address)														

*Note: Cylinder bytes and the high-order head bytes are obtained from the user, not from the sense bytes. The low-order head byte is obtained from sense byte 6, bits 3 through 7.*

**Action Explanation**

**5B** This action is used to restart a Read Multiple CKD data recovery process after a correctable data check has been processed. Reconstruct the Read Multiple CKD as follows:

- a. Build restart CCW 2.
- b. If a Define Extent command was executed, go to step c. Otherwise, set command code to X'5E'.

Restart the operation by executing:

Seek	(see Note below)
Set File Mask	(same as original)
Read Home Address	(skip bit on)
Search ID Equal	(CCHHR from sense bytes 8 through 12)
TIC *-8	
Read Multiple CKD	(from step a)
TIC (ICCW Address)	(pointer established while building CCW 2 + 8)

- c. If a Define Extent command was executed, restart the operation executing:

Define Extent	(same as original)
Locate Record	(same as action 5, step e)
Read Multiple CKD	(from action 5B, step a)
TIC (ICCW Address)	(indicated CCW address minus 8 if the user's chain has not been completed)

- 6
  - a. Increment the cylinder portion of the user's seek argument by 1. Reset the head address to zero.
  - b. If the modified seek argument is not within the user's extent, IOS must supply the correct seek argument before issuing the Seek. If that is impossible, IOS must do action 2.
  - c. If a Define Extent command was executed, go to step d. Otherwise, continue the operation by executing:

Seek	(argument from step b)
Set File Mask	(same as original)
Set Sector	(argument 0)
Read Home Address	(skip flag on)
TIC (ICCW Address)	(indicated CCW address minus 8)

- d. Continue the operation by executing:

Seek	(argument from step b)
Define Extent	(user's extent compatible with seek argument, other parameters same as original)
Set Sector	(argument 0)
Read Home Address	(skip flag on)
TIC (ICCW Address)	(indicated CCW address minus 8)

*Note: Cylinder bytes and the high-order head bytes are obtained from the user, not from the sense bytes. The low-order head byte is obtained from sense byte 6, bits 3 through 7.*

**Action Explanation**

- 7
- a. If the interrupted CCW is a Seek or Locate Record, go to step b. Otherwise, do action 7A.
  - b. Determine whether the seek argument is within the user's extent or extents. If not, do action 2. Otherwise, go to step c if the command is a Seek, or to step d if it is a Locate Record.
  - c. Continue the operation by executing:

Seek	(user's argument)
Define Extent (if used)	(user's extent compatible with seek argument, other parameters same as original)
Set File Mask (if no Define Extent)	(same as original)
Set Sector	(argument 0)
Read Home Address	(skip flag on)
TIC (ICCW Address)	(indicated CCW address)

- d. Define Extent (user's extent compatible with seek argument, other parameters same as original)

TIC (ICCW Address) (indicated CCW address minus 8)

- 7A
- a. This is a multitrack operation. Increment the user's seek argument by 1.
  - b. If the modified seek argument is not within the user's extent, IOS must supply the correct seek argument before issuing the Seek. If that is impossible, IOS must do action 2.
  - c. If a Define Extent command was executed, do action 7B. Otherwise, continue the operation by executing:

Seek	(argument from step a)
Set File Mask	(same as original)
Set Sector	(argument 0)
Read Home Address	(skip bit on)
TIC (ICCW Address)	(indicated CCW address minus 8)



**Action Explanation**

7B a. If sense byte 3 is not zero, go to step b.  
Otherwise, continue the operation be executing:

Define Extent	(user's extent compatible with seek argument from action 7A, other parameters same as original)
Locate Record	(byte 0 equals X'40', bytes 1 through 3 equal 0, bytes 4 through 7 equal the seek argument from action 7A, bytes 8 through 11 equal the CCHH of the seek argument, and bytes 12 through 15 equal 0.)

TIC (ICCW Address) (indicated CCW address minus 8)

b. When sense byte 3 is not zero, the Locate Record command in whose domain the interrupt occurred must be found by scanning the chain. A new Locate Record command is created to continue operations by using the parameters from the original.

Bytes 0 through 2 are the same as the original, byte 3 is set to the value in sense byte 3, bytes 4 through 7 contain the seek argument from action 7A, bytes 8 through 12 are set to the CCHH of the seek argument, bytes 12 and 13 are zero, and bytes 14 and 15 are the same as the original.

c. The difference between the record count (byte 3) and sense byte 3 equals the number of records already processed. Use this number to find the first CCW of the original domain that remains to be processed. This CCW is called to as the continuation CCW.

d. Examine the continuation CCW. If it is a Write CKD Next Track command, go to step e. Otherwise, continue the operation by executing:

Define Extent	(user's extent compatible with seek argument from action 7A, other parameters same as original)
Locate Record	(from step b)
TIC	(continuation CCW)

e. When the continuation CCW is a Write CKD Next Track command, continue the operation by executing:

Define Extent	(user's extent compatible with seek argument from action 7A, other parameters same as original)
Locate Record	(from step b)
Write CKD	(same as continuation CCW except for operation code)
TIC	(next non-TIC CCW after the continuation CCW)

## Chapter 12. Sense Bytes – 3380

Sense information for the 3380 (24 bytes) identifies the conditions that caused the last unit check status to be generated. The sense information also provides secondary information for system error recovery and for diagnosing and isolating storage director and device malfunctions.

### Sense Byte 0

#### Bit 0 - Command Reject

Bit 0 is set by:

- An invalid command code
- An invalid command sequence
- An invalid or incomplete argument transferred by a control command
- A track formatted without a home address
- Issuing a Set Path Group ID or Sense Path Group ID command to a device that does not have the dynamic path selection function
- Attempting a format write command (other than Write Home Address or Write R0) on a defective track
- Issuing a write command that violates the file mask
- A record zero count field of a defective or an alternate track that points to itself
- An attempt was made to write an invalid home address

If the speed matching buffer for 3380 feature is installed in the 3880, command reject is also set if:

- A command has been received in the domain of a Locate Record command that does not conform with the operation parameter. (See the description of the Locate Record command for additional information.)
- The operation specified by a Locate Record command is inhibited by the file mask.

### **Bit 1 - Intervention Required**

Bit 1 is set by addressing a device that is not attached to the system, by setting the device Enable/Disable switch to Disable if a Model AD4/BD4, AE4/BE4, AJ4/BJ4, and AK4/BK4, or by addressing a device that is in CE mode.

### **Bit 2 - Bus Out Parity**

Bit 2 is set when a parity error is detected during transfer of a command from the channel to the 3880.

### **Bit 3 - Equipment Check**

Bit 3 is set when an unusual hardware condition occurs in the channel, storage director, or device. The condition is further defined in sense bytes 3 through 23.

### **Bit 4 - Data Check**

Bit 4 is set when the storage director detects a data error in the information received from the device. If byte 2, bit 1 (correctable) is also set, the data error is correctable and bytes 15 through 23 provide correction information. Sense byte 7 defines the specific nature of the condition.

If the 3380 AJ4/AK4 Attachment (Feature 3005) is installed, bit 4 is set when the storage director encounters:

- A correctable data error detected in the information received from the device for transfer to the channel. If byte 2, bit 1 (correctable) is also set, the data error is correctable and bytes 20 through 23 provide correction information.
- PCI fetch mode active in the file mask and an uncorrectable data check is corrected during channel command retry. Byte 2, bit 1 (correctable) is also set.
- A data check cannot be corrected. Sense byte 7 defines the specific nature of this condition. Byte 1, bit 0 (permanent error) is also on.

### **Bit 5 - Overrun**

Bit 5 is set when the storage director does not receive a response to a data request within a specified period of time.

Detection of an overrun may cause requests for data from the channel to be terminated. When writing, the remaining portion of the record area is padded with a replicated data byte.

All data overrun conditions are retried by the storage director except those that occur after the first record processed by a Read Multiple Count, Key, and Data command and those that occur during a format write operation (unless the data overrun occurred during a format write within the domain of a Locate Record command).

The storage director presents an overrun only if the condition occurs more than ten times in the same CCW chain, or if the overrun occurs during one of the above operations not retried by the storage director.

Command overruns are also retried by the storage director and do not cause an overrun to be presented.

#### **Bit 6**

Bit 6 is not used. It is set to zero.

#### **Bit 7**

Bit 7 is not used. It is set to zero.

### **Sense Byte 1**

#### **Bit 0 - Permanent Error**

Bit 0 is set when error recovery procedures that were initiated by a storage director have been exhausted and were unsuccessful, or when retry was not possible or desirable.

The bit overrides any other bit settings and indicates that system error recovery procedures are not required.

#### **Bit 1 - Invalid Track Format**

Bit 1 is set when:

- An attempt is made to write data exceeding track capacity.
- An index point is detected in the gap that precedes a key or data field.
- A previous operation attempted to write data exceeding the track capacity; this operation resulted in a record written into index. This record was encountered while attempting to execute a read, search, or write command. As long as this record remains on the track, invalid track format may be presented while attempting to locate a record successfully written on the track. However, a Search ID will be able to execute on any count field successfully written on the track without presenting invalid track format.

#### **Bit 2 - End of Cylinder**

Bit 2 is set when a multitrack read or search operation continues past the end of the cylinder boundary.

### **Bit 3 - Message to Operator**

Bit 3 is set when there is a permanent failure in the other storage director in the same 3880 or a state save operation in the reporting storage director. Byte 0, bit 3 (equipment check) is also set. A message will be sent to the operator console.

This bit is also set when the storage director has completed sense data logging of a particular error type. Format 0, message 1 or 2 is indicated in byte 7. Byte 2, bit 3 (environmental data present) is also set.

### **Bit 4 - No Record Found**

Bit 4 is set when two index points have been detected in the same CCW chain without an intervening read operation in the home address area or data area, or without an intervening write, sense, or control command.

If the speed matching buffer for 3380 feature is installed in the 3880, this bit is also set if the proper record is not found during execution of a Locate Record command.

### **Bit 5 - File Protected**

Bit 5 is set to indicate that a seek command or read or search multitrack operation violated the file mask.

If the speed matching buffer for 3380 feature is installed in the 3880, this bit is also set if:

- An attempt was made to access or operate on a track outside the boundaries established by a Define Extent command.
- A Locate Record operation attempts to exceed the extent boundaries.

### **Bit 6 - Write Inhibited**

Bit 6 is set to indicate that the Diagnostic Control command has inhibited write operations on this data path. Byte 0, bit 3 (equipment check) is also set. All devices on the string using this data path are set to Read Only mode.

### **Bit 7**

Bit 7 is not used. It is set to zero.

## Sense Byte 2

### Bit 0 - Request Write Inhibit

Bit 0 is set only if the 3380 AJ4/AK4 Attachment (Feature 3005) is installed on the Model 3. The storage director has requested that the host issue a Diagnostic Control command with Inhibit Write specified.

### Bit 1 - Correctable

Bit 1 is set when the data check condition indicated by byte 0, bit 4 (data check) is correctable.

### Bit 2 - First Logged Error

Bit 2 is set along with byte 2, bit 3 to indicate that the error rate of temporary seek checks or temporary data checks has exceeded a predetermined level and logging mode has been set for the device.

### Bit 3 - Environmental Data Present

Bit 3 is set to indicate that bytes 8 through 23 contain usage statistics or error statistics, or error log information. Byte 7 indicates the format for bytes 8 through 23.

When set with byte 1, bit 3, the message to the operator is defined by byte 7 (X'01' = sense data logged for device or X'02' = sense data logged for controller).

See byte 2, bit 2 for additional information about this bit.

### Bit 4 - Intent Violation

If the speed matching buffer for 3380 feature is installed in the 3880, bit 4 is used to indicate an intent violation. This bit is set if one of the following occurs during execution of a data transfer command in the domain of a Locate Record command.

- An update write operation is attempted on a record whose size differs from the record size parameters.
- An update write operation is attempted on R0 and the data area is not 8 bytes in length.

This bit is also set if a record is not detected after home address during execution of a Write CKD Next Track, Write Update Data, or Write Update Key and Data command.

Bit 4 is used only if the speed matching buffer for 3380 feature is installed or if 3380 Models AD4, AE4, AJ4, and AK4 are attached to the 3880. Otherwise it is set to zero.

### **Bit 5 - Imprecise Ending**

Bit 5 is used to indicate an imprecise ending condition. This bit is set if an abnormal channel program termination occurs and the status presented is for a previously executed command. It indicates that the CCW address is not in sync with the transfer of data from the storage director to the disk.

Bit 5 is used only if the speed matching buffer for 3380 feature is installed in the 3880 or if 3380 Models AD4, AE4, AJ4, or AK4, are attached to the 3880.

### **Bit 6 - Write Operations**

Bit 6 is set to indicate that an error occurred during execution of a write operation.

### **Bit 7 - Model 3 with 3380 AJ4/AK4 Attachment (Feature 3005)**

Bit 7 is set to zero to indicate the sense information is from a 3380 Model 3 with the 3380 AJ4/AK4 Attachment (Feature 3005) installed.

## **Sense Byte 3**

For formats 1, 2, 6, 7 and 8, byte 3 contains the controller ID. This byte is not used for formats 0, 3, 4 and 5 unless the speed matching buffer for 3380 feature is installed in the 3880.

If the speed matching buffer for 3380 feature is installed in the 3880, the value in this byte (formats 0, 3, 4 and 5 only) indicates the number of records that remain to be processed in the domain of a Locate Record command after the channel program was terminated with unit check status and imprecise ending sense data.

It should be noted that sense byte 3, Format 4 has different uses, depending upon:

- If the Environmental Data Present bit is set on, then this byte indicates the number of subsystem retries attempted by the storage director to make the record useable.
- If the Permanent bit is set on and the Imprecise Ending bit is active, this byte indicates the number of remaining records to be processed in the domain of the Locate Record command.
- If the Permanent bit is set on and the Imprecise Ending bit is not active, this byte is set to zero.

### **Bit 0**

Bit 0 contains the logical address of the controller.

**Bits 1 through 6**

Not used.

**Bit 7**

When on, bit 7 indicates the A2 controller.

**Sense Byte 4**

**For 3380 Models AA4/B04, AD4/BD4, and AE4/BE4:**

**Bit 0**

Bit 0 indicates that the controller has the dynamic path selection function (always X'1' for 3380 Model 23).

**Bit 1**

Bit 1 indicates that the sense data is from a 3380 Model AD4/BD4 or AE4/BE4 device.

**Bit 2**

Bit 2 indicates a permanent path error (Used in Format 7 only, otherwise, it is zero.)

**Bit 3**

Bit 3 is always zero.

**Bit 4**

Bit 4 indicates spindle address 4.

**Bit 5**

Bit 5 indicates spindle address 2.

**Bit 6**

Bit 6 indicates spindle address 1.

**Bit 7**

Bit 7 where 0 indicates the left actuator and 1 indicates the right actuator.



For 3380 Models AJ4/BJ4, and AK4/BK4:

**Bits 0 and 1**

Bits 0 and 1 indicate the controller path.

**Bit 2**

Bit 2 indicates the string address

**Bit 3**

Bit 3 is always zero.

**Bit 4**

Bit 4 indicates spindle address 4.

**Bit 5**

Bit 5 indicates spindle address 2.

**Bit 6**

Bit 6 indicates spindle address 1.

**Bit 7**

Bit 7 where 0 indicates the left actuator and 1 indicates the right actuator.

**Sense Byte 5**

**Bits 0 through 7 - Cylinder-Low Address**

Bits 0 through 7 identify the low-order cylinder address of the most recent access position.

In conjunction with sense Format 3 (microcode detected), byte 5 indicates the high-order byte of the instruction address register.

In conjunction with sense Format 6, byte 5 indicates the number of diskette checks after an initial microcode load (IML) or a storage director-to-storage director communication failure.

- Bit 0 = Communication failure during an IML
- Bit 1 = Not used
- Bits 2-4 = Diskette check (seek errors)
- Bits 5-7 = Diskette check (read errors)

## Sense Byte 6

### Bits 0 through 7 - Cylinder-High and Head

Bits 0 through 7 identify the high-order cylinder and head address of the most recent access position.

Cylinder Address	Head Address
Bit 0 = 0	Bit 4 = 8
Bit 1 = 1024	Bit 5 = 4
Bit 2 = 512	Bit 6 = 2
Bit 3 = 256	Bit 7 = 1

In conjunction with sense Format 3 (microcode detected), byte 6 indicates the low-order byte of the instruction address register.

In conjunction with sense Format 6, byte 6 identifies the storage director.

## Sense Byte 7

### Bits 0 through 3 - Format

Bits 0 through 3 specify the format of sense bytes 8 through 23 as follows:

0000	= Format 0 – program or system checks
0001	= Format 1 – device equipment checks (CE information)
0010	= Format 2 – storage director equipment checks (CE information)
0011	= Format 3 – storage director control checks (CE information)
0100	= Format 4 – data checks without displacement information
0101	= Format 5 – data checks with displacement information (Format 5 also may be presented on errors which are not ECC correctable are not ECC correctable but which require restart displacement information.)
0110	= Format 6 – usage statistics/overrun errors
0111	= Format 7 – storage director-to-controller path or controller checks (CE information)
1000	= Format 8 – controller equipment checks (CE information)
1001	= Format 9 – read/write equipment checks.

### Bits 4 through 7 - Message

Bits 4 through 7 describe the specific nature of the error conditions for each of the above formats. The message table that accompanies the format descriptions specifies the function of the message bits for the format.

## Format Identifier

Sense bytes 5, 6 and 8 through 23 are defined differently depending on the format identified in bits 0 through 3 of byte 7. For Format 3, the message identifier must also be known to define those bytes.

For Formats 0 through 9 (except Format 3), the bits in this Format Identifier identify the specific format of sense bytes 5-6 and 8-23. For Format 3, these bits plus the Message Identifier identify the specific format of sense bytes 5-6 and 8-23.

The chart below shows the general use of each format.

CODE	MEANING
0000	Format 0 - Program or system checks
0001	Format 1 - Device equipment checks
0010	Format 2 - Storage Director equipment checks
0011	Format 3 - Storage director control checks
0100	Format 4 - Uncorrectable data checks
0101	Format 5 - Correctable data checks
0110	Format 6 - Usage, overrun, and error statistics
0111	Format 7 - Device connection control checks
1000	Format 8 - Controller check 2 and device check 1
1001	Format 9 - Device read/write equipment checks

### Notes:

- Format 5 may also be presented on errors that are not ECC correctable but require restart displacement information.*
- Formats 1, 4, 5, 7, and 9 pertain to device errors and are described in the device's maintenance library.*
- Format 9 is used only for 3380 Models AJ4/BJ4 and AK4/BK4; 3380 Models AA4/B04, AD4/BD4, and AE4/BE4 use Format 1.*

## Format 0 – Program or System Check

Format 0 is used when sense bytes 0 through 7 completely describe the error or unusual condition caused by a program or system error.

### Bytes 8 through 19

Bytes 8 through 19 are not used. They are set to zero.

### Byte 20

If byte 1, bit 3 (message to operator) and byte 2, bit 3 (environmental data present) are on, byte 20 contains the controller physical ID. Otherwise, byte 20 is not used.

### Byte 21

Byte 21 contains the storage director ID.

### Bytes 22 and 23

Bytes 22 and 23 contain the symptom code.

## Message Table – Format 0 (Byte 1, Bit 3 = 0)

The following tables give a brief description of the error messages available in Format 0.

Following the message tables is a description of the conditions of Format 0 and a listing of the meanings of bytes 8 through 23. When Message to Operator (byte 1, bit 3) is on, Format 0 messages are as follows:

<b>Sense Byte 7, Bits 4-7 =</b>	<b>Message Number</b>	<b>Meaning</b>
0000	0	No message. No additional information required.
0001	1	Soft error logging complete for device.
0010	2	Soft error logging complete for controller.
1111	F	Soft error logging complete for subsystem storage.

When Message to Operator (byte 1, bit 3) is off, Format 0 messages are as follows:

<b>Sense Byte 7, Bits 4-7 =</b>	<b>Message Number</b>	<b>Meaning</b>
0000	0	An invalid command was issued to the 3880.
0010	2	An invalid command sequence was issued to the 3880.
0011	3	The CCW count was less than required for the command.
0100	4	An invalid argument was used for the command.
0101	5	Diagnostic read or write command not permitted by the file mask.
0110	6	Retry status was presented and the channel did not indicate chaining.
0111	7	The command code of the CCW returned after a retry sequence did not match the command for which the retry was presented.
1000-1010	8-A	Not used.
1011	B	The track address contained in the RO count area of a defective or alternate track is the same as the address of that track, or on a 3380 Model AE4/BE4, AJ4/BJ4, or AK4/BK4 the cylinder contained in the RO count area on a defective track is not in the alternate track range for that range.
1100	C	Dynamic path selection installation configuration check.
1101-1111	D-F	Not used.

## Format 1 – Device Equipment Check

Format 1 is generated for 3380 Models AA4/B04, AD4/BD4, or AE4/BE4 without Feature 3005 installed, when:

- A device, device interface, or controller equipment check is detected. Equipment check (byte 0, bit 3) is also on.
- A permanent device logic seek check is detected. Equipment check (byte 0, bit 3) and permanent error (byte 1, bit 0) are also on. The message bits in byte 7 indicate a seek error. If the error is associated with a subsystem storage to DASD transfer, environmental data present (byte 2, bit 3) is also on.
- The microcode an error, such as timeout of some device activity, which is normally reported using this format. Which sense bits that are on depends on the type of error detected. If the error is associated with a subsystem storage to DASD transfer, environmental data present (byte 2, bit 3) will also be on.
- Error log information must be unloaded after the occurrence of a successfully retried seek check that was recognized during error logging mode or forced error logging mode. Environmental data present (byte 2, bit 3) is also on. The message bits in byte 7 indicate a seek error.
- Online indication is not found in the file status (byte 8, bit 4). Intervention required (byte 0, bit 1) is also on. If the error is associated with a subsystem storage to DASD transfer, environmental data present (byte 2, bit 3) is also on.

Format 1 is generated for 3380 Models AD4/BD4 or AE4/BE4 with Feature 3005 installed, when:

- A device equipment check is detected. Equipment check (byte 0, bit 3) is set on.
- A permanent device logic seek check is detected. Equipment check (byte 0, bit 3) and permanent error (byte 1, bit 0) are also on. The message bits in byte 7 indicate a seek error.
- The microcode detected one of the errors, such as timeout of some device activity, which is normally reported using this format. The sense bits that are on depend on the type of error detected. Equipment check (byte 0, bit 3) is set on.
- Error log information must be unloaded after the occurrence of a successfully retried seek check that was recognized during error logging mode or forced error logging mode. Environmental data present (byte 2, bit 3) is also on and the message bits in byte 7 indicate a seek error.

- Online indication is not found in the file status (byte 19 bit 4). If byte 19 bit 6 (busy) or byte 20 bit 5 (device switch set to disabled) are set, then byte 20 bit 1 (intervention required) and the message code in byte 7 are set to on. Otherwise, if byte 19 bit 6 (busy) or byte 20 bit 5 (device switch set to disabled) are 0, then byte 0 bit 3 (equipment check) is set and the message code in byte 7 is set to 8.

Format 1 is generated for 3380 Models AJ4/BJ4 and AK4/BK4 with Feature 3005 installed, when:

- A device or controller equipment check is detected that meets one of the following conditions:
  - Byte 11 is **not** X'04' or X'00'.
  - Byte 11 is X'00' and the error is not a microcode detected seek.
- The microcode detected one of the errors, such as timeout of some device activity, which is normally reported using this format. The sense bits that are on depend on the type of error detected.
- Error log information must be unloaded after the occurrence of a successfully retried seek check that was recognized during error logging mode or forced error logging mode. Environmental data present (byte 2, bit 3) is also on. The message bits in byte 7 indicate a seek error.
- Online indication is not found in the file status (byte 19 bit 4). If byte 19 bit 6 (busy) or byte 20 bit 5 (device switch set to disabled) are set, then byte 20 bit 1 (intervention required) and the message code in byte 7 are set to on. Otherwise, if byte 19 bit 6 (busy) or byte 20 bit 5 (device switch set to disabled) are 0, then byte 0 bit 3 (equipment check) is set and the message code in byte 7 is set to 8.

The following defines bytes 8 through 23 for sense from 3380 Models AA4/B04, AD4/BD4, or AE4/BD4:

<b>Byte 8</b>	Contents of control interface bus out. This byte is valid with messages 1, 4, 5, 6, 8, D and F.
<b>Byte 9</b>	Contents of control interface bus in. This byte contains the End OP code for message 6 and the response to the command for messages 1, 4, 5, 6, 8, D, and F.
<b>Byte 10</b>	Device power status.
<b>Byte 11</b>	Device check register.
<b>Byte 12</b>	Read/write status 1.
<b>Byte 13</b>	Read/write status 2.

<b>Byte 14</b>	Read/write status 3 for Models AD4, BD4, AE4, and BE4. Machine level Head checks for Models AA4, A04, and B04.
<b>Byte 15</b>	Checkpoint log.
<b>Byte 16</b>	Expected device 1 status for message 1 or physical cylinder address for messages 7, A, or E.
<b>Byte 17</b>	Physical track address (low) read for messages 7, A, or E.
<b>Byte 18</b>	Read/write status 4 for Models AD4, BD4, AE4, and BE4. Not used for Models AA4, A04 and B04.
<b>Byte 19</b>	Device status 1



**For Models AA4/B04:**

Bit 0 = Padding in progress  
Bit 1 = Servo inhibited  
Bit 2 = Seek incomplete  
Bit 3 = Device check 2/Set sector incomplete. This bit summarizes servo inhibit, seek, incomplete, device check 2, and set sector incomplete.  
Bit 4 = Online  
Bit 5 = Head disk assembly attention  
Bit 6 = Device busy  
Bit 7 = Locate interrupt

**For Models AD4/BD4 and AE4/BE4:**

Bit 0 = Padding in progress  
Bit 1 = Bit = 0 for AD4/BD4 and Bit = 1 for AE4/BE4  
Bit 2 = Seek incomplete  
Bit 3 = Device check 2/Set sector incomplete. This bit summarizes servo inhibit, seek, incomplete, device check 2, and set sector incomplete.  
Bit 4 = Online  
Bit 5 = Head disk assembly attention  
Bit 6 = Device busy  
Bit 7 = Locate interrupt

**Byte 20 Device status 2**

**For Models AA4/B04:**

Bit 0 = Device logic disabled  
Bit 1 = Surge complete  
Bit 2 = Offset active  
Bit 3 = Drive motor latch  
Bit 4 = Accessor mechanism logic exchanged  
Bit 5 = Not used  
Bit 6 = Right accessor mechanism selected  
Bit 7 = Left accessor mechanism selected

**For Models AD4/BD4 and AE4/BE4:**

Bit 0 = Device logic disabled  
Bit 1 = Surge complete  
Bit 2 = Offset active  
Bit 3 = Drive motor latch  
Bit 4 = Accessor mechanism logic exchanged  
Bit 5 = Device switch disabled  
Bit 6 = Accessor selected  
Bit 7 = Seek incomplete

**Byte 21 Storage director ID.**

**Bytes 22 and 23 Fault symptom code.**

The following defines bytes 8 through 23 for sense from 3380 Models AJ4/BJ4 or AK4/BK4:

**Byte 8 – Features**

Bit 0 = Dynamic path selection hardware installed  
Bit 1 = Always zero  
Bit 2 = Always zero  
Bit 3 = Always zero  
Bit 4 = Always zero  
Bits 5-7 = 001 for 3380 Models AJ4/BJ4 or AK4/BK4

### **Byte 9 – Director Controller Interface**

If the message in byte 7 is 1, this byte contains the expected value of device status 1.

If the message in byte 7 is not 1, this byte contains the value on DDC bus in at the time the error occurred.

### **Byte 10 – Device Power Status**

Bit 0 = Motor start surge complete  
Bit 1 = Always zero  
Bit 2 = No air flow  
Bit 3 = Device sequence complete  
Bit 4 = Motor started by device sequencer  
Bit 5 = Spindle control bit 0  
Bit 6 = Motor brake latch on  
Bit 7 = Spindle control bit 1

### **Byte 11 – Device Check Register**

Bit 0 = Device sequencer check  
Bit 1 = Servo control check  
Bit 2 = Rotational position sensing check  
Bit 3 = Checkpoint check  
Bit 4 = Head disk assembly cable swap check  
Bit 5 = Read/Write check  
Bit 6 = Power check  
Bit 7 = Funnel parity check

### **Byte 12 – Servo Status 0**

### **Byte 13 – Servo Status 0**

### **Byte 14 – Servo Status 1, first byte**

### **Byte 15 – Checkpoint Log**

Bit 0 = Error detected  
Bits 1-7 = Contents of the checkpoint log register

### **Byte 16 – Servo Status 1, second byte**

### **Byte 17 – Servo Status 2**

### **Byte 18 – Servo Status 2**

### **Byte 19 – Device Status 1**

Bit 0 = Padding in progress  
Bits 1-2 Device type  
    00 J  
    01 K  
Bit 3 = Device error. This bit summarizes servo inhibit, seek, incomplete, device check 2, and set sector incomplete.  
Bit 4 = Online  
Bit 5 = Head disk assembly attention  
Bit 6 = Device busy  
Bit 7 = Locate interrupt

## Byte 20 – Device Status 2

Bit 0 = Device logic disabled  
Bit 1 = Servo inhibit  
Bit 2 = Offset active  
Bit 3 = Drive motor switch off  
Bit 4 = Accessor mechanism logic exchanged  
Bit 5 = Device switch set to disable  
Bit 6 = Actuator selected  
Bit 7 = Seek incomplete

## Byte 21 – Storage Director Identification Register

Byte 21 contains the contents of the storage director identification register.

Bytes 22 and 23 contain the symptom code.

## Message Table – Format 1

The following table gives a brief description of the error messages available in Format 1.

Sense Byte 7, Bits 4-7 =	Message Number	Meaning
0000	0	No message. No additional information is required.
0001	1	Device status 1 not as expected.
0010	2	Successful recovery of one type of uncorrectable data check.
0011	3	Index missing.
0100	4	Interrupt not resettable.
0101	5	Device does not respond to selection.
0110	6	Device check 2 or Set Sector command incomplete.
0111	7	If sense is from a 3380 Model AA4/B04, AD4/BD4, or AE4/BE4, then head address does not compare. If sense is from a 3380 Model AJ4/BJ4 or AK4/BK4, bits 4-7 are not used.
1000	8	Device status 1 invalid.
1001	9	Device not ready to do customer work.
1010	A	If sense is from a 3380 Model AA4/B04, AD4/BD4, or AE4/BE4, track physical address does not compare. If sense is from a 3380 Model AJ4/BJ4 or AK4/BK4, bits 4-7 are not used.
0010	B	Missing device address bit at device selection.
1100	C	Drive motor switch sensed off.
1101	D	Seek incomplete.
1110	E	If sense is from a 3380 Model AA4/B04, AD4/BD4, or AE4/BE4, cylinder address does not compare. If sense is from a 3380 Model AJ4/BJ4 or AK4/BK4, bits 4-7 are not used.
1111	F	Offset active cannot be reset.

If sense is from a 3380 Model AJ4/BJ4 or AK4/BK4, bits 4-7 are not used.

## Format 2 – Storage Director Equipment Check

Format 2 is generated to provide sense information when the microcode detects a storage director error condition.

<b>Byte 8</b>	Contents of the transfer complete status (XCS) register.
<b>Byte 9</b>	Contents of the transfer error status (XES) register.
<b>Byte 10</b>	Contents of the check (CHK) register.
<b>Byte 11</b>	Contents of the channel transfer complete (CXC) register.
<b>Byte 12</b>	Contents of channel control 2 (CC2) register.
<b>Byte 13</b>	Contents of the device bus out (DBO) register.
<b>Byte 14</b>	Contents of the device bus in (DBI) register.
<b>Byte 15</b>	Contents of the device tag out (DTO) register.
<b>Byte 16</b>	Contents of the device tag gate (DTG) register.
<b>Byte 17</b>	Contents of the device tag in (DTI) register.
<b>Byte 18</b>	Contents of channel status 2 (CS2) register.
<b>Byte 19</b>	Not used unless the speed matching buffer for 3380 feature is installed in the 3880. This byte then represents the contents of the toggle/FRU register.
<b>Byte 20</b>	Byte 20 indicates microcode-detected check 2 conditions.
<b>Byte 21</b>	Storage director ID.
<b>Bytes 22 and 23</b>	Symptom code.

## Message Table – Format 2

The following table gives a brief description of the error messages available in Format 2.

<b>Sense Byte 7, Bits 4-7 =</b>	<b>Message Number</b>	<b>Meaning</b>
0000-0111	0-7	Reserved for other types of storage control units.
1000	8	No message. No additional information is required.
1001	9	Selective reset occurred while the device was selected.
1010	A	Failed to latch the First Sync In Line.
1011-1110	B	Not used
1100	C	Channel failed to respond to a selective reset request.
1101-1110	D-E	Not used.
1111	F	Microcode selected check. The message appears in byte 20.

## Format 3 – Storage Director Control Check (Hardware Detected)

This Format 3 is generated to report microcontroller control checks detected by the hardware.

<b>Byte 8</b>	Contents of the field-replaceable unit (FRU) register 2 (bit 4 = 0).
<b>Byte 9</b>	Contents of check register 1.
<b>Byte 10</b>	Contents of check register 2.
<b>Byte 11</b>	Contents of check register 3.
<b>Byte 12</b>	Not used.
<b>Byte 13</b>	Not used.
<b>Byte 14</b>	Not used.
<b>Byte 15</b>	Contents of FRU register 3.
<b>Byte 16</b>	Contents of FRU register 4.
<b>Byte 17</b>	Not used.
<b>Byte 18</b>	Not used.
<b>Byte 19</b>	Not used.
<b>Byte 20</b>	Not used.
<b>Byte 21</b>	Storage director ID.
<b>Bytes 22 and 23</b>	Symptom code.

### Message Table – Format 3

The following table gives a brief description of the error messages available in Format 3.

<b>Sense Byte 7, Bits 4-7 =</b>	<b>Message Number</b>	<b>Meaning</b>
0000-0111	0-7	Reserved for other types of storage control units.
1000	8	Clock stopped check 1.
1001	9	Channel check 1 or storage director timeout.
1010	A	Trace-table saved in this storage director.
1011-1111	B-F	Not used.

## Format 3 – Storage Director Control Check (Microcode Detected)

This Format 3 is generated to report microcontroller control checks detected by the microcode. This format presents the contents of the following registers to the alternate microcontroller for message 9. For message A, this format is reported by the failing microcontroller.

<b>Byte 8</b>	Not used.
<b>Byte 9</b>	Contents of the transfer error status (XES) register.
<b>Byte 10</b>	Contents of the check (CHK) register.
<b>Byte 11</b>	Contents of the condition register 0 (CR0).
<b>Byte 12</b>	Contents of the channel status 2 (CS2) register.
<b>Byte 13</b>	Contents of the channel control 1 (CC1) register.
<b>Byte 14</b>	Contents of the channel control 2 (CC2) register.
<b>Byte 15</b>	Contents of the channel status 1 (CS1) register.
<b>Byte 16</b>	Contents of the channel status 3 (CS3) register.
<b>Byte 17</b>	Contents of the channel transfer control (CXC) register.
<b>Byte 18</b>	Contents of the channel bus out (CBO) register.
<b>Byte 19</b>	Contents of the channel bus in (CBI) register.
<b>Byte 20</b>	Contains the timeout message when sense bytes 22 and 23 contain a symptom code of 3F2X. Otherwise, this byte is the interrupt level.
<b>Byte 21</b>	Storage director ID.
<b>Bytes 22 and 23</b>	Symptom code.

## Message Table – Format 3

<b>Sense Byte 7, Bits 4-7 =</b>	<b>Message Code</b>	<b>Meaning</b>
0000-1000	0-8	Not used.
1001	9	Channel check 1 or storage director timeout.
1010	A	Trace table saved in this storage director.
1011-1111	B-F	Not used.

## Format 4 – Data Check Without Displacement Information

Format 4 is generated for 3380 Models AA4/B04, AD4/BD4, or AE4/BE4 without Feature 3005 installed, when:

- An ECC uncorrectable error for which retry has been unsuccessful has been detected. Permanent error (byte 1, bit 0) and data check (byte 0, bit 4) are also on. The message bits in byte 7 identify the error type and field.
- Error log information was offloaded after an ECC uncorrectable error that was recovered by command retry. Environmental data present (byte 2, bit 3) is also on.

Format 4 is generated for 3380 Models AD4/BD4 or AE4/BE4 with Feature 3005 installed, when:

- An ECC uncorrectable error for which retry has been unsuccessful has been detected. Permanent error (byte 1, bit 0) and data check (byte 0, bit 4) are also on. The message bits in byte 7 identify the error type and field.
- An ECC uncorrectable error occurred that cannot be retried because the retry is inhibited by the Diagnostic Mode bit in the File Mask. Data Check (byte 0, bit 4) is set. The message bits in byte 7 identify the error type and field.
- Offloading of error log information is necessary after an ECC uncorrectable error, which was not permanent, occurred during error logging mode. Environmental Data Present (byte 2, bit 3) is set on.

Format 4 is generated for 3380 Models AJ4/BJ4 or AK4/BK4 with Feature 3005 installed, when:

- An ECC uncorrectable error for which retry has been unsuccessful has been detected. Data check (byte 0, bit 4) is on. The message bits in byte 7 identify the error type and field.
- An ECC uncorrectable data check occurred that cannot be retried because the retry is inhibited by the Diagnostic Mode bit in the File Mask. Data Check (byte 0, bit 4) is set on. The message bits in byte 7 identify the error type and field.
- Offloading of error log information is necessary after the occurrence of data check, which was not permanent, while in logging mode. Environmental Data Present (byte 2, bit 3) is set on.



## **Bytes 8 through 12 - Record Identifier**

Bytes 8 through 12 contain the record ID obtained from the count field of the record in which the error occurred. These bytes are unreliable if the message code in byte 7 is 0, 1, 4, 5, 8, 9, C, or D. Byte 12 is zero if the message code is 0 or 4. These bytes are also unreliable after a Space Count command if an ECC uncorrectable error occurred.

## **Byte 13 - Sector Number**

Byte 13 contains the sector number of the record in error. These bytes are unreliable if the message code in byte 7 is 0, 1, 4, 5, 8, 9, C, or D.

## **Byte 14 - Controller - Physical Identifier**

Byte 14 contains the controller physical identifier.

## **Byte 15 - Offset Level**

If sense is from 3380 Models A04, AA4/B04, AD4/BD4, or AE4/BE4, and byte 2, bit 3 (environmental data present) is on, byte 15 contains the head offset last used for retrying a data check.

If sense is from 3380 Models AJ4/BJ4 or AK4/BK4, and byte 2, bit 3 (environmental data present) is on, byte 15 contains the head offset last used for retrying a data check. The bits are defined as:

Bit 0 - 3 = Units of offset  
Bit 4 = Loss of fine track  
Bit 5 = Extra subsystem recovery operation  
Bit 6 = Zero  
Bit 7 = Forward direction

## **Byte 16 - ECC Status**

Byte 16 is not used with 3380 Models AA4/B04, AD4/BD4, or AE4/BE4.

## **Byte 17**

Byte 17 is not used with 3380 Models AA4/B04, AD4/BD4, or AE4/BE4.

If sense is from 3380 Models AJ4/BJ4 or AK4/BK4; byte 17 contains the first level error count.

| **Bytes 18 through 20**

| Bytes 18 through 20 are not used with 3380 Models AA4/B04, AD4/BD4, or  
| AE4/BE4.

| If sense is from 3380 Models AJ4/BJ4 or AK4/BK4; these bytes are zero.

| **Byte 21**

| Byte 21 contains the storage director physical ID.

| **Bytes 22 and 23**

| Bytes 22 and 23 are the symptom code.

## Message Table – Format 4

The following tables give a brief description of the error messages available in Format 4 for 3380 Models AA4/B04, AD4/BD4, and AE4/BE4:

<b>Sense Byte 7, Bits 4-7 =</b>	<b>Message Number</b>	<b>Meaning</b>
0000	0	An error occurred in the home address area and could not be corrected by the ECC.
0001	1	An error occurred in the count area and could not be corrected by the ECC.
0010	2	An error occurred in the key area and could not be corrected by the ECC.
0011	3	An error occurred in the data area and could not be corrected by the ECC.
0100	4	Data synchronization on the home address area was unsuccessful.
0101	5	Data synchronization on the count area was unsuccessful.
0110	6	Data synchronization on the key area was unsuccessful.
0111	7	Data synchronization on the data area was unsuccessful.
1000	8	An error occurred in the home address area and could not be corrected by the ECC with offset active.
1001	9	An error occurred in the count area and could not be corrected by the ECC with offset active.
1010	A	An error occurred in the key area and could not be corrected by the ECC with offset active.
1011	B	An error occurred in the data area and could not be corrected by the ECC with offset active.
1100	C	Data synchronization on the home address area was unsuccessful with offset active.
1101	D	Data synchronization on the count area was unsuccessful with offset active.
1110	E	Data synchronization on the key area was unsuccessful with offset active.
1111	F	Data synchronization on the data area was unsuccessful with offset active.

The following tables give a brief description of the error messages available in Format 4 for 3380 Models AJ4/BJ4 and AK4/BK4:

<b>Sense Byte 7, Bits 4-7 =</b>	<b>Message Number</b>	<b>Meaning</b>
0000	0	Data check in home address area.
0001	1	Data check in the count area.
0010	2	Data check in the key area.
0011	3	Data check in the data area.
0100	4	No synchronization byte found in the home address area.
0101	5	No synchronization byte found in the count area.
0110	6	No synchronization byte found in the key area.
0111	7	No synchronization byte found in the data area.
1000-1111	8-F	Not used.

## **Format 5 – Data Check With Displacement Information**

Format 5 is generated for 3380 Models AA4/B04, AD4/BD4, or AE4/BE4 without Feature 3005 installed, when:

- An ECC correctable data check is detected in a data area. Data check (byte 0, bit 4) and Correctable (byte 2, bit 1) are on.
- An ECC uncorrectable data check is detected in a data area, the command was successfully retried, and the file mask indicated PCI fetch mode. Data check (byte 0, bit 4) and Correctable (byte 2, bit 1) are on. Error displacement and correction patterns are set to zero.
- Offloading of error log information is necessary after an ECC correctable error occurred during error logging mode. Environmental Data Present (byte 2, bit 3) is also on. The message code in byte 7 identifies the area that contained the ECC correctable error.
- A data check is encountered associated with a Read Multiple Count, Key, and Data command. Data Check (byte 0, bit 4) and Correctable (byte 2, bit 1) are also on.
- An ECC correctable data check is encountered in the count or key area when retry is inhibited by the file mask. Data check (byte 0, bit 4) and Correctable (byte 2, bit 1) are on.

Format 5 is generated for 3380 Models AD4/BD4 or AE4/BE4 with Feature 3005 installed, when:

- A correctable data check is detected in information received from the device for transfer to the channel and File Mask inhibits data correction. Data check (byte 0, bit 4) and Correctable (byte 2, bit 1) are on.
- Data check was recovered with the Channel Command Retry and the file mask indicated PCI fetch mode. Data check (byte 0, bit 4) and Correctable (byte 2, bit 1) are on. Error displacement and correction patterns are set to zero.
- Offloading of error log information is necessary after an ECC correctable error occurred during error logging mode. The message code in byte 7 identifies the area that contained the ECC correctable error. Environmental Data Present (byte 2, bit 3) is set on.
- A data check is encountered associated with a Read Multiple Count, Key, and Data command. Data Check (byte 0, bit 4) and Correctable (byte 2, bit 1) are also on.

Format 5 is generated for 3380 Models AJ4/BJ4 and AK4/BK4 with Feature 3005 installed, when:

- A data check was recovered with the Channel Command Retry and the file mask indicated PCI fetch mode. Data check (byte 0, bit 4) and Correctable (byte 2, bit 1) are on.

The error displacement and correction patterns are set to zero. Correctable (byte 2, bit 1) is set for sense records built as a result of a data check while running under PCI fetch mode.

- A data check is encountered associated with a Read Multiple Count, Key, and Data command. Data Check (byte 0, bit 4) and Correctable (byte 2, bit 1) are also on.

*Note: It is the users responsibility to perform single reads when an error occurs; otherwise data may not be recovered and there may be no record of the fact.*

### **Bytes 8 through 12 - Record Identification**

Bytes 8 through 12 contain the record identification obtained from the count field of the record in which the error occurred. These bytes are unreliable if the message code in byte 7 is 0, 1, 8, or 9. Byte 12 is unreliable after a Space Count command.

### **Byte 13 - Sector Number**

Byte 13 contains the sector number of the record in error.

### **Byte 14 - Controller - Physical Identifier**

Byte 14 contains the controller physical identifier.

### **Bytes 15 through 17 - Restart Displacement**

If byte 2, bit 3 = 0, bytes 15 through 17 contain the restart displacement. If byte 2, bit 3 = 1, byte 15 contains the head offset, byte 16 contains the storage director ID, and byte 17 is not used.

### **Bytes 18 and 19 - Error Displacement**

Bytes 18 and 19 contain the error displacement.

### **Bytes 20 through 23 - Error Pattern**

Bytes 20 through 23 contain the error pattern.

## Message Table – Format 5

The following table gives a brief description of the error messages available in Format 5.

<b>Sense Byte 7, Bits 4-7 =</b>	<b>Message Number</b>	<b>Message Description</b>
0000	0	Correctable data check in home address area.
0001	1	Correctable data check in count area.
0010	2	Correctable data check in key area.
0011	3	Correctable data check in data area.
0100-0111	4-7*	Not used.
1000	8*	Correctable data check in home address area with offset active.
1001	9*	Correctable data check in count area with offset active.
1010	A*	Correctable data check in key area with offset active.
1011	B*	Correctable data check in data area with offset active.
1100-1111	C-F*	Not used.

*Note: \* Messages 4 through F are not used with 3380 Models AJ4|BJ4 or AK4|BK4.*

## **Format 6 – Usage Statistics/Overrun Errors**

Format 6 is generated when:

- A Read and Reset Buffered Log command is executed.
- Usage/error statistics require off-loading due to counter overflow.

### **Bytes 8 through 11 - Bytes Read or Searched**

Bytes 8 through 11 contain an accumulated count of the number of bytes processed by the storage director during read and search operations. Only key and data fields are counted. Bytes processed during retry operations are not counted.

### **Bytes 12 through 15**

Bytes 12 through 15 are not used.

### **Bytes 16 and 17 - Number of Seeks**

Bytes 16 and 17 contain the number of access moves processed by the storage director, but do not include recalibrated or retried seeks.

### **Byte 18**

Byte 18 is not used.

### **Byte 19 - Command Overruns**

Byte 19 contains the number of command overruns that occurred on the channel specified in the message table of byte 7.

### **Byte 20 - Data Overruns**

Byte 20 contains the number of data overruns that occurred on the channel specified in the message table of byte 7.

### **Byte 21**

Storage director ID.

### **Bytes 22 and 23**

Bytes 22 and 23 are not used.

## Message Table – Format 6

The following table gives a brief description of the error messages available in Format 6.

<b>Sense Byte 7, Bits 4-7 =</b>	<b>Message Number</b>	<b>Message Description</b>
0000-0111	0-7	Not used.
1000	8	Channel A overrun counts in bytes 19 and 20.
1001	9	Channel B overrun counts in bytes 19 and 20.
1010	A	Channel C overrun counts in bytes 19 and 20.
1011	B	Channel D overrun counts in bytes 19 and 20.
1100	C	Channel E overrun counts in bytes 19 and 20.
1101	D	Channel F overrun counts in bytes 19 and 20.
1110	E	Channel G overrun counts in bytes 19 and 20.
1111	F	Channel H overrun counts in bytes 19 and 20.

*Note: For 3380 Models AJ4/BJ4 and AK4/BK4, the overrun counts are in bytes 14 and 20.*



## **Format 7 – Storage Director-to-Controller Path or Controller Checks**

Format 7 is generated to provide sense information when a controller type 1 (check 1) error occurs. This format is also generated to indicate to the system that a path error exists between the storage director and the controller.

If the 3380 Data Path switch is switched to Disable after the storage director and controller have established initial communication and the storage director attempts to use the path, this format indicates an equipment check error. If use is attempted prior to initial communication and the Data Path switch is set to Disable, a condition code response results. (In other IBM DASD products a disabled interface is always indicated to the system.)

If the sense information is from a 3380 Model AA4/B04, AD4/BD4, or AE4/BE4; bytes 8 through 23 contain the following:

### **Byte 8**

Contents of control interface bus out.

### **Byte 9**

Contents of control interface bus in.

### **Byte 10**

Contents of the storage director device tag in (DTI) and transfer error status (XES) registers.

### **Byte 11**

Byte 11 indicates which controllers sensed a connection check or do not have power on.

### **Bytes 12 and 13**

Bytes 12 and 13 indicate check 1 errors that occurred in the controller with a logical address of 0.

### **Bytes 14 and 15**

Bytes 14 and 15 indicate the check 1 errors that occurred in the controller with a logical address of 1.

## Bytes 16 and 17

### Models AD4, BD4, AE4, and BE4:

Bytes 16 and 17 contain the controller 0 sequencer check 1 connection check alert (CCA).

Byte 16 contains the coded indication of the cause of sequencer detected check 1 in byte 13, bit 2.

Byte 17:

Bit 0 = Sequencer in bus parity check	Bit 4 = Power sequence complete
Bit 1 = 0	Bit 5 = Check 2 active
Bit 2 = 0	Bit 6 = Successful data transfer controller 0
Bit 3 = 0	Bit 7 = Always 0 (indicates a successful data transfer)

## Bytes 18 and 19

### Models AA4, A04, and B04:

Bytes 18 and 19 contain the controller 1 sequencer address at the time of a CCA.

### Models AD4, BD4, AE4 and BE4:

Bytes 18 and 19 contain the controller 1 sequencer check 1 connection check alert (CCA).

Byte 18 contains the coded indication of the cause of a sequencer detected check 1 in byte 15, bit 2.

Byte 19:

Bit 0 = Sequencer in bus parity check	Bit 4 = Power sequence complete
Bit 1 = 0	Bit 5 = Check 2 active
Bit 2 = 0	Bit 6 = Successful data transfer controller 1
Bit 3 = 0	Bit 7 = Always 0 (indicates a successful data transfer)

## Byte 20

Byte 20 contains format and message codes reported in byte 7 when controller first indicated a path was disabled. Used with message codes C and D.

## Byte 21

Storage director ID.

## Bytes 22 and 23

Symptom code.

If the sense information is from a 3380 Model AJ4/BJ4 or AK4/BK4: bytes 8 through 23 contain the following:

### Byte 8 - Features

This byte is set to X'FF' if the data is not available to the storage director.

Bit 0 = Dynamic path selection hardware installed  
Bit 1 = Always zero  
Bit 2 = Always zero  
Bit 3 = Always zero  
Bit 4 = Always zero  
Bit 5-7 = 001

### Byte 9 - Device Bus In Register

Bits 0 through 7 equal the contents of the device bus in register.

### Byte 10 - Device Tag In and Transfer Error Status Registers

Bit 0 = Connection check alert (CCA)  
Bit 1 = Tag in check  
Bit 2 = Sync in check  
Bit 3 = Director-to-device connection (DDC)  
bus in parity check  
Bit 4 = DDC tag-in null disconnect  
Bit 5 = DDC tag-in sync in  
Bit 6 = DDC tag-in selected null  
Bit 7 = DDC tag-in end op

### Byte 11

Bit 0 = RCC bit 0, String 0  
Bit 1 = RCC bit 0, String 1  
Bit 2 = RCC bit 1, String 0  
Bit 3 = RCC bit 1, String 1  
Bit 4 = RCC bit 15, String 0  
Bit 5 = RCC bit 15, String 1  
Bit 6 = RCC bit 16, String 0  
Bit 7 = RCC bit 16, String 1

### Byte 12

Bit 2-9, String 0

### Byte 13

Bits 0-4 RCC bits 10-14, String 1  
Bits 5-7 Zero

**Byte 14**

RCC Bits 2-9, String 1

**Byte 15**

Bits 0-4 RCC bits 10-14, String 1  
Bits 5-7 Zero

**Byte 16**

RCC bits 17-24, String 0

**Byte 17**

RCC bits 25-32, String 0

**Byte 18**

RCC bits 17-24, String 1

**Byte 19**

RCC bits 25-32, String 1

**Byte 20 - Original Format and Message Code 2**

If the message code is 4, C, or D, this byte contains the original format and message code. Otherwise, this byte is zero.

**Byte 21 – Storage Director Identification Register**

Byte 21 contains the contents of the storage director identification register.

**Bytes 22 and 23** contain the symptom code.

## Message Table – Format 7

The following table gives a brief description of the error messages available in Format 7.

<b>Sense Byte 7, Bits 4-7 =</b>	<b>Message Number</b>	<b>Meaning</b>
0000	0	Request connection check (RCC) initiated by a connection check alert (CCA).
0001	1	RCC1 sequence was not successful.
0010	2	RCC1 and RCC2 sequence were not successful.
0011	3	Invalid tag in during selection sequence.
0100	4	Extra RCC required.
0101	5	Invalid director-to-device connection selection response or storage director timeout.
0110	6	Missing end operation, transfer was complete.
0111	7	Missing end operation, transfer was incomplete.
1000	8	Invalid tag in for an immediate command sequence.
1001	9	Invalid tag in for an extended command sequence.
1010	A	Storage director microcode timed out on deselection.
1011	B	No selection response after poll interrupt.
0110	C	Controller not available.
1101	D	Controller not available on disconnected command chain.
1110-1111	E and F	Not used.

Format 7 is generated when control checks result from a device connection error.

## Format 8 – Controller Equipment Check

Format 8 is generated to provide sense information when controller type 2 and drive check 1 equipment checks occur. If the sense information is from a 3380 Model AA4/B04, AD4/BD4, or AE4/BE4; bytes 8 through 23 contain the following:

<b>Byte 8</b>	Contents of control interface bus out.
<b>Byte 9</b>	Contents of control interface bus in. Contains the End Op response code if sense byte 10, bit 7 is on, or if the message code is 3, 4, or 5.
<b>Byte 10</b>	Contents of the device tag in (DTI) and transfer error status (XES) registers.
<b>Byte 11</b>	Controller fault log A.
<b>Byte 12</b>	Controller fault log B.
<b>Byte 13</b>	Controller fault log C.
<b>Byte 14</b>	Controller fault log D.
<b>Byte 15</b>	Controller fault log E.
<b>Bytes 16 and 17</b>	Bytes 16 and 17 contain the controller sequencer address at the time of the check.
<b>Byte 18</b>	Controller fault log F.
<b>Byte 19</b>	Device status 1

### For Models AA4/B04:

Bit 0 = Padding in progress  
Bit 1 = Servo inhibited  
Bit 2 = Seek incomplete  
Bit 3 = Device check 2/Set sector incomplete. This bit summarizes servo inhibit, seek, incomplete, device check 2, and set sector incomplete.  
Bit 4 = Online  
Bit 5 = Head disk assembly attention  
Bit 6 = Device busy  
Bit 7 = Locate interrupt

### For Models AD4/BD4 and AE4/BE4:

Bit 0 = Padding in progress  
Bit 1 = Bit = 0 for AD4/BD4 and Bit = 1 for AE4/BE4  
Bit 2 = Seek incomplete  
Bit 3 = Device check 2/Set sector incomplete. This bit summarizes servo inhibit, seek, incomplete, device check 2, and set sector incomplete.  
Bit 4 = Online  
Bit 5 = Head disk assembly attention  
Bit 6 = Device busy  
Bit 7 = Locate interrupt

**Byte 20** Device status 2

**For Models AA4/B04:**

Bit 0 = Device logic disabled  
Bit 1 = Surge complete  
Bit 2 = Offset active  
Bit 3 = Drive motor latch  
Bit 4 = Accessor mechanism logic exchanged  
Bit 5 = Not used  
Bit 6 = Right accessor mechanism selected  
Bit 7 = Left accessor mechanism selected

**For Models AD4/BD4 and AE4/BE4:**

Bit 0 = Device logic disabled  
Bit 1 = Surge complete  
Bit 2 = Offset active  
Bit 3 = Drive motor latch  
Bit 4 = Accessor mechanism logic exchanged  
Bit 5 = Device switch disabled  
Bit 6 = Accessor selected  
Bit 7 = Seek incomplete

**Byte 21** Storage director ID.

**Bytes 22 and 23** Symptom code.

If the sense information is from a 3380 Model AJ4/BJ4 or AK4/BK4: bytes 8 through 23 contain the following:

**Byte 8 – Features**

Bit 0 = Dynamic path selection hardware installed  
Bit 1 = Always zero  
Bit 2 = Always zero  
Bit 3 = Always zero  
Bit 4 = Always zero  
Bit 5-7 = 001

**Byte 9 – Device Bus In Register**

Bits 0 through 7 equal the contents of the device bus in register.

**Byte 10 – Device Tag In and Transfer Error Status Registers**

Bit 0 = Connection check alert (CCA)  
Bit 1 = Tag in check  
Bit 2 = Sync in check  
Bit 3 = Director-to-device connection (DDC)  
bus in parity check  
Bit 4 = DDC tag-in null disconnect  
Bit 5 = DDC tag-in sync in  
Bit 6 = DDC tag-in selected null  
Bit 7 = DDC tag-in end op

### **Byte 11 – Controller Fault A**

Bit 0 = Data-handling phase locked oscillator (DHPL0)  
delta frequency check  
Bit 1 = DHPL0 failed to lock  
Bit 2 = DHPL0 multiple select  
Bit 3 = DHPL0 non-drive check  
Bit 4 = Read/write data cable check  
Bit 5 = Data valid check  
Bit 6 = Read time out  
Bit 7 = Zero

### **Byte 12 – Controller Fault B**

Bit 0 = Serializer deserializer (SERDIES)  
control check  
Bit 1 = Clock/SERDIES/ECC check  
Bit 2 = SERDIES path check  
Bit 3 = Write pattern check  
Bits 4-7 = Always zero

### **Byte 13 – Controller Fault C**

Bits 0-1 = Always zero  
Bit 2 = Dynamic path selection (DPS)  
command latch  
Bit 3 = Multiplexer input parity check  
Bit 4 = Control device port register 3  
parity check  
Bit 5 = IOC card check-2  
Bit 6 = Precomposition check  
Bit 7 = Write gap 3 control check

### **Byte 14 – Controller Fault D**

Bit 0 = Device 0, 4, 8, or C check 1  
Bit 1 = Device 1, 5, 9, or D check 1  
Bit 2 = Device 2, 6, A, or E check 1  
Bit 3 = Device 3, 7, B, or F check 1  
Bits 4-5 = Isolation bits  
00 = DPS tie break check  
01 = Clock check  
10 = Port card check  
11 = CPD interface check  
Bits 6-7 CPD port selected

### **Byte 15 – Controller Fault E**

Bit 0 = DPS array check  
Bit 1 = DPS internal check  
Bit 2 = DPS compare check  
Bit 3 = DPS controller or controller  
connection check  
Bit 4 = DPS storage address register  
check  
Bit 5 = DPS internal register  
check  
Bit 6 = DPS alternate check  
Bit 7 = Always zero



### **Byte 16 – Controller Fault F**

Bit 0 = Data transfer bus (DTB)  
out parity check  
Bit 1 = DTB bus in parity check  
Bit 2 = DTB control check  
Bit 3 = Read/write gate DDC  
driver check  
Bits 4-7 = These bits define the 3880  
configuration as follows:  
0 = A  
4 = AB  
8 = ABB  
C = AB BB

### **Byte 17 – Controller Fault G**

Bit 0 = Controller to CDP card check  
Bit 1 = Drive to CDP card check  
Bit 2 = Port response check  
Bit 3 = CDP active drivers check  
Bit 4 = Selected device check-1  
Bit 5 = Sub-string 0 selected  
Bit 6 = Sub-string 1 selected  
Bit 7 = Always zero

### **Byte 18 - Controller Checkpoint Register**

Byte 18 contains the contents of the controller checkpoint register.

### **Byte 19 - Device Status 1**

### **Byte 20 - Device Status 2**

### **Byte 21 - Storage Director Identification Register**

Byte 21 contains the contents of the storage director identification register.

**Bytes 22 and 23** contain the fault symptom code.

## Message Table – Format 8

The following table gives a brief description of the error messages available in Format 8.

<b>Sense Byte 7, Bits 4-7 =</b>	<b>Message Number</b>	<b>Meaning</b>
0000	0	Not used.
0001	1	ECC hardware check.
0010	2	Not used.
0011	3	Unexpected end operation response code received.
0100	4	End operation received with transfer count equal to zero.
0101	5	End operation received with transfer count equal to zero.
0110	6	Controller stopped dynamic path selection cleanup after a channel or system reset.
0111	7	Dynamic path selection array cannot be initialized.
1000	8	There was a short busy timeout during service.
1001	9	The controller failed to set or reset the long busy latch.
1000-1111	A-F	Not used.

## Format 9 – Device Read/Write Equipment Check

Format 9 is generated to provide sense information for device read/write equipment checks. This format is used only for 3380 Models AJ4/BJ4 and AK4/BK4; 3380 Models AA4/B04, AD4/BD4, and AE4/BE4 use Format 1 to report these types of errors. Format 9 is generated when:

- Detection of a device equipment that has a value of X'04' in byte 11. In this case, Byte 0, bit 3 (equipment check) is set and the message code in byte 7 will be either a 6 or 0.
- Detection of a microcode-detected permanent device seek check. Byte 0, bit 3 (equipment check) is set and the message code in byte 7 specifies a seek error.
- Error log information is off-loaded after a successfully retried seek that occurred during error logging. Byte 2, bit 3 (environmental data present) is also set if the message code in byte 7 specifies a seek error.

The following defines bytes 8 through 23 for sense from 3380 Models AJ4/BJ4 and AK4/BK4:

<b>Byte 8</b>	Features.
<b>Byte 9</b>	DDC bus in.
<b>Byte 10</b>	Device power status.
<b>Byte 11</b>	Device check register.
<b>Byte 12</b>	Read/write status 1.
<b>Byte 13</b>	Read/write status 2.
<b>Byte 14</b>	Read/write status 3.
<b>Byte 15</b>	Checkpoint log.
<b>Byte 16</b>	Track physical address 1. This byte contains the least significant cylinder address bits.
<b>Byte 17</b>	Track physical address 2. Bits 0-3 contain the most significant cylinder address bits and bits 4-7 contain the head address.
<b>Byte 18</b>	Read/write status 4.
<b>Byte 19</b>	Device status 1.
<b>Byte 20</b>	Device status 2.
<b>Byte 21</b>	Storage director ID.
<b>Bytes 22 and 23</b>	Fault symptom code.

## Message Table – Format 9

The following table gives a brief description of the error messages available in Format 9.

Following the message table is a description of the conditions of Format 9 and a listing of the meanings of bytes 8 through 23.

<b>Sense Byte 7, Bits 4-7 =</b>	<b>Message Number</b>	<b>Meaning</b>
0000	0	No message. No information required.
0001	1	Not used.
0010	2	Not used.
0011	3	Not used.
0100	4	Not used.
0101	5	Not used.
0110	6	Device Check 2.
0111	7	Head address miscompare.
1000	8	Not used.
1001	9	Not used.
1010	A	Track physical address miscompare.
1011	B	Not used.
1100	C	Not used.
1101	D	Not used.
1110	E	Cylinder address miscompare.
1111	F	Not used.

## Error Condition Table – 3380

Byte	Bit	Name	General Description	Action	Logged
0	0	Command reject	Programming error.	2	No
0	1	Intervention required	Drive offline.	3	No
0	2	Bus out parity	Bus out parity error.	3	Yes
0 0 2 2**	3 0 5	Equipment check Request write inhibit Imprecise ending	Equipment malfunction.	4	Yes*
0 1 2	3 6 5	Equipment check Write Inhibited Imprecise ending	Write operations inhibited on this data path by a Diagnostic Control command.	4B	Yes
0 1 2	3 0 5	Equipment check Permanent error Imprecise ending	Equipment malfunction. Storage director retry exhausted or undesirable.	1	Yes
0 1 2	3 0 3	Equipment check Permanent error Environmental data present	Permanent equipment malfunction of the alternate storage director or undesirable operation in reporting storage director.	4A	Yes
0 1 1 2	3 0 3 5	Equipment check Permanent error Message to operator Imprecise ending	Equipment malfunction—retry exhausted or undesirable (condition related to current channel program) Additional messages required.	1	Yes
0 1	3 3	Equipment check Message to operator	Permanent equipment malfunction of the alternate storage director, or trace table save in reporting SD.	4	Yes
0** 2**	4 5	Data check Imprecise ending	Uncorrectable data check. (Condition related to current program channel program.)	4	Yes
0 1 1 2	3 0 3 3	Equipment check Permanent error Message to operator Environmental data present	Communication failure or microcode logic error. Retry exhausted. Message required.	4A	Yes
0 4	3 2	Equipment check Permanent path error	Permanent equipment check in the path to the addressed device.	14	Yes
	4	Data check	Data check not correctable with a Read Multiple CKD command.	4	No

Byte	Bit	Name	General Description	Action	Logged
0** 1** 2**	3	Equipment check Message to operator Environmental data present	Permanent equipment malfunction during IML.	4A	Yes
0 1 2	4 0 5	Data check Permanent error Imprecise ending			
0 2	4 1	Data check Correctable			
0	5	Overrun	Service overrun on second or subsequent segment of a format write or a Read Multiple CKD.	4	Yes
1 2	1 5	Invalid track format Imprecise ending	Track capacity exceeded.	2	No
1	2	End of cylinder	Cylinder boundary detected during a multitrack operation or detected during a multitrack operation not within the Locate Record command domain.	8	No
1 2	3 3	Message to operator Environmental data present	Exit from sort error log mode	4A	Yes
1 2	4 5	No record found Imprecise ending			
1	5	File protected	The Seek command or read and/or search multitrack operation violated the file mask or not in the Locate Record command domain.	10	No
2 2	2 3	First error log Environmental data present	Soft error logging has been initiated for the device or controller.	4A	Yes
2	3	Environmental data present	Statistical usage/error information, error log information requires transfer to OBR or command redrive.	4A	YES
2	4	Intent violation	Operation has violated the intent specified by LOCATE RECORD.	2	No

*Notes:*

1. \*If sense byte 7 contains X'29', no logging occurs.
2. \*\*Used only if the 3380 AJ4/AK4 (Feature 3010) is installed.

## Recovery Action Table – 3380

Action	Explanation
1	Print the console error message.
2	Exit with programming error or unusual condition indication.
3	a. Repeat the operation once. b. If the error condition persists, do action 1.
4	<b>The following applies only to 3380 Models A04, AA4/B04.</b> a. If message to operator (byte 1, bit 3) is set, print console message defined by sense byte 7. b. Repeat the operation using the same data path. c. If the error persists after 10 retries, 1) If Request Write Inhibit (byte 2, bit 0) is set on, issue a Diagnostic Control command with the Inhibit Write Subcommand and byte 1 sub-modifier = X'20' (inhibit writes through this channel.) 2) For Format 8, if byte 11 bit 0, byte 12 bit 0 or 1, byte 13 bits 1, 2, and 3, are on or FSC equals 8501, 8607, 8707, or 8807, issue a Diagnostic control with the Inhibit Write subcommand and byte 1 submodifier = X'40' (inhibit writes through this channel). 3) For formats 7 or 8, if FSC equals 8001, 8002, 8611, 8711, or 8DXX issue a Diagnostic Control with the Inhibit Write subcommand and byte 1 submodifier = X'80' (inhibit writes through this storage director). 4) If none of the above are true do action 1; otherwise continue. d. Print a console message requesting CE notification. e. If an alternate path is available, repeat the operation using the alternate data path.

**Action Explanation****The following applies only to 3380 Models AD4/AE4.**

- a. If message to operator (byte 1, bit 3) is set, print console message defined by sense byte 7.
- b. Repeat the operation using the same data path.
- c. If the error persists after 10 retries,
  - 1) If Request Write Inhibit (byte 2, bit 0) is set on, issue a Diagnostic Control command with the Inhibit Write Subcommand and byte 1 sub-modifier = X'20' (inhibit writes through this channel.)
  - 2) For Format 8, if byte 11 bit 0, byte 12 bit 0 or 1, byte 13 bits 1, 2, and 3, are on or FSC equals CD07 or CF81, issue a Diagnostic control with the Inhibit Write subcommand and byte 1 submodifier = X'40' (inhibit writes through this channel).
  - 3) For formats 7 or 8, if FSC equals CD11, issue a Diagnostic Control with the Inhibit Write subcommand and byte 1 submodifier = X'80' (inhibit writes through this storage director).
  - 4) If none of the above are true do action 1; otherwise continue.
- d. Print a console message requesting CE notification.
- e. If an alternate path is available, repeat the operation using the alternate data path.

**The following applies only to 3380 Models AJ4/BJ4 and AK5/BK4.**

- a. If message to operator (byte 1, bit 3) is set, print console message defined by sense byte 7.
- b. Repeat the operation using the same data path.
- c. If the error persists after 10 retries,
  - 1) If Request Write Inhibit (byte 2 bit 0) is set on, issue a Diagnostic Control command with the Inhibit Write subcommand and byte 1 sub-modifier = X'20' (inhibit writes through this DASD controller).
  - 2) If Format 0, or Format 2 and bytes 22-23 = X'270' or X'27F'; issues a Diagnostic control with the Inhibit Write subcommand and byte 1 submodifier = X'40' (inhibit writes through this channel).
  - 3) If Format 2 and bytes 22-23 are neither X'270' nor X'27F'; issue a Diagnostic Control with the Inhibit Write subcommand and byte 1 submodifier = X'80' (inhibit writes through this storage director).
  - 4) If none of the above are true do action 1; otherwise continue.
- d. Print a console message requesting CE notification.
- e. If an alternate path is available, repeat the operation using the alternate data path.

- 4A a. If message to operator (byte 1, bit 3) is set, print the console message defined by sense byte 7.
- b. Repeat the operation.
- c. If the error condition persists after 256 retries, perform action 1.
- 4B a. Print the console error message.
- b. If an alternate data path is available, repeat the operation using the alternate data path.



**Action Explanation**

- 5
- a. Perform the error correction function.
  - b. Examine bit 7 of the file mask. If off, go to step c. If on, indicate that the data has been corrected. The user is operating PCI fetch mode and must supply the restart recovery action.
  - c. Examine the interrupted CCW (indicated CCW address minus 8). If it is a Read Multiple CKD, do action 5B; otherwise, continue. If the user's chain is not complete, examine the next non-TIC command in the chain. If the CCW is a Write Special CKD, Read Sector, Space Count, or if bit 3 of the CCW is 1, go to step d. Otherwise, do action 5A.
  - d. If a Define Extent command was executed, go to step e. Otherwise, continue the user's chain by executing:

Seek (see Note below)  
 Set File Mask (same as original)  
 Read Home Address (skip bit on)  
 Search ID Equal (CCHHR from sense bytes 8 through 12)  
 TIC \*.8  
 TIC (ICCW Address) (indicated CCW address)

- e. A Define Extent command was executed. Continue the user's chain by executing:

Define Extent (same as original)  
 Locate Record (Byte 0 equals X'80' if sense byte 3 equals zero. Otherwise, byte 0 equals X'86', bytes 1 and 2 are zero, byte 3 equals the value in sense byte 3, bytes 4 through 7 equal the address in sense bytes 5 and 6, bytes 8 through 12 equal the address in sense bytes 8 through 12, and bytes 13 through 15 are set to zero.)  
 TIC (ICCW Address) (indicated CCW address)

- 5A If a Define Extent command was executed, do action 5, step e. Otherwise, continue the user's chain by executing:

Seek (see Note below)  
 Set File Mask (same as original)  
 Read Home Address (skip bit on)  
 Search ID Equal (CCHHR from sense bytes 8 through 12)  
 TIC \*.8  
 Read Count (skip bit on, multitrack command if next non-TIC CCW has bit 0 on)  
 TIC (address of CCW examined in Action 5, step C-3).

*Note: Cylinder bytes and the high-order head bytes are obtained from the user, not from the sense bytes. The low-order head byte is obtained from sense byte 6, bits 3 through 7.*

**Action Explanation**

**5B** This action is used to restart a Read Multiple CKD data recovery process after a correctable data check has been processed. Reconstruct the Read Multiple CKD as follows:

- a. Build restart CCW 2.
- b. Set command code to X'5E'.
- c. If a Define Extent command was executed, go to step d.

Restart the operation by executing:

Seek (see Note below)  
Set File Mask (same as original)  
Read Home Address (skip bit on)  
Search ID Equal (CCHHR from sense byte 8 through 12)  
TIC \*8  
Read Multiple CKD (from step a)  
TIC (ICCW Address) (pointer established while building CCW 2+8)

- d. A Define Extent command was executed. Restart the operation by executing:

Define Extent (same as original)  
Locate Record (same as action 5, step e)  
Read Multiple CKD (from action 5B, step b)  
TIC (indicated CCW address if the user's chain has not been completed)

**Action Explanation**

- 6
- a. Increment the cylinder portion of the seek address in sense bytes 5 and 6 by 1. Reset the head address to zero.
  - b. If the incremented cylinder address is still in the current extent, go to step c. Otherwise, determine the seek address by locating the next extent. If none exists, do action 2.
  - c. If a Define Extent command was executed, go to step d. Otherwise, continue the operation by executing:

Seek (argument from step b)  
 Set File Mask (same as original)  
 Set Sector (argument 0)  
 Read Home Address (skip flag on)  
 TIC (ICCW Address) (indicated CCW address minus 8)

- d. Continue the operation by executing:

Seek (argument from step b)  
 Define Extent (user's extent compatible with seek argument, other parameters same as original)  
 Set Sector (argument 0)  
 Read Home Address (skip flag on)  
 TIC (ICCW Address) (indicated CCW address minus 8)

*Note: Cylinder bytes and the high-order head bytes are obtained from the user, not from the sense bytes. The low-order head byte is obtained from sense byte 6, bits 3 through 7.*

- 7
- a. If the interrupted CCW is a Seek or Locate Record, go to step b. Otherwise, do action 7A.
  - b. Determine whether the seek argument is within the user's extent or extents. If not, do action 2. Otherwise, go to step c if the command is a Seek, or to step d if it is a Locate Record.
  - c. Continue the operation by executing:

Seek (user's argument)  
 Define Extent (user's extent compatible with seek argument)  
 (if used) other parameters same as original)  
 Set File Mask (same as original)  
 (if no Define Extent)  
 Set Sector (argument 0)  
 Read Home Address (skip flag on)  
 TIC (ICCW Address) (indicated CCW address)  
 Define Extent (user's extent compatible with seek argument, other parameters same as original)  
 TIC (ICCW Address) (indicated CCW address minus 8)

**Action Explanation**

7A This is a multitrack operation.

- a. Increment the address in sense bytes 5 and 6 by 1. If the incremented address is still within the current extent, go to step b. Otherwise, determine the seek address by locating the next extent. If none exists, do action 2.
- b. If a Define Extent command was executed, do action 7B. Otherwise, continue the operation by executing:

Seek (argument from step a)  
Set File Mask (same as original)  
Set Sector (argument 0)  
Read Home Address (skip bit on)  
TIC (ICCW Address) (indicated CCW address minus 8)

**Action Explanation**

7B a. If sense byte 3 is not zero, go to step b. Otherwise, continue the operation by executing:

Define Extent	(user's extent compatible with seek argument from action 7A, other parameters same as original)
Locate Record	(byte 0 equals X'40', bytes 1 through 3 equal 0, bytes 4 through 7 equal the seek argument from action 7A, bytes 8 through 11 equal the CCHH of the seek argument, and bytes 12 through 15 equal 0)
TIC (ICCW Address)	(indicated CCW address minus 8)

b. When sense byte 3 is not zero, the Locate Record command in whose domain the interrupt occurred must be found by scanning the chain. A new Locate Record command is created to continue operations by using the parameters from the original.

Bytes 0 through 2 are the same as the original, byte 3 is set to the value in sense byte 3, bytes 4 through 7 contain the seek argument from action 7A, bytes 8 through 11 are set to the CCHH of the seek argument, bytes 12 and 13 are zero, and bytes 14 and 15 are the same as the original.

The difference between the record count (byte 3) and sense byte 3 equals the number of records already processed. Use this number to find the first CCW of the original domain that remains to be processed. This is the same as (indicated CCW address minus 8) if imprecise ending is not set. This CCW is called the continuation CCW.

Examine the continuation CCW. If it is a Write CKD Next Track command, go to step c. Otherwise, continue the operation by executing:

Define Extent	(user's extent compatible with seek argument) from action 7A, other parameters same as original)
Locate Record	
TIC	(continuation CCW)

c. When the continuation CCW is a Write CKD Next Track command, continue the operation by executing:

Define Extent	(user's extent compatible with seek argument) from action 7A, other parameters same as original)
Locate Record	(from step b)
Write CKD	(same as continuation CCW except for operation code)
TIC	(next non-TIC CCW after the continuation CCW)

8 a. If any alternate path to the device is available, do action 4. Otherwise, mark the designated path unavailable, then do action 1.

## Chapter 13. Operator Panel

The operator panel consists of switches and indicators that are used to monitor and control the functions of the 3380 and its attached disk storage. Refer to Figure 13-1 for an illustration. The following paragraphs explain the switches and indicators on the panel.

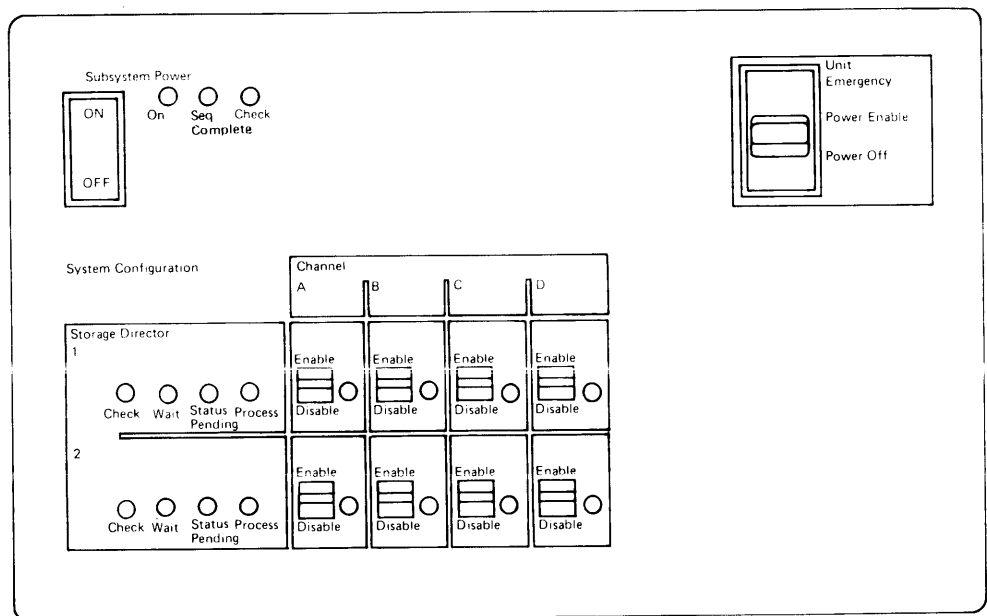

**Figure 13-1. 3380 Operator Panel**

*Note: This System Configuration shown in the illustration is for a 3380 with the two-channel switch pair, additional feature installed.*

### Subsystem Power

**On/Off switch** provides manual control of subsystem power.

**On** indicates that power is applied to the subsystem.

**Seq Complete** indicates that a signal has been sent to the processor verifying that power sequencing for the subsystem is completed. If power is turned off after Seq Complete comes on, wait two minutes before turning power back on.

**Check** indicates that there is a problem in the power circuitry.

## System Configuration

**Check** indicates that there is a malfunction in the associated storage director.

**Wait** indicates that this storage director is in the wait state and is not processing any information.

**Process** indicates that the associated storage director is processing information.

**Status Pending** indicates that the associated storage director has status pending or is in a contingent connection.

**Enable/Disable** switches must be in the Enable position before the associated storage director is available to the channel. When the indicator is on, the channel is disabled. (The switch configuration shown is for a 3880 with the two-channel switch pair, additional feature installed.)

## Unit Emergency

**Power Enable/Power Off** switch is provided for operator control of subsystem power in case of an emergency.

## Appendix A. Appendix - Device Addressing

The device addresses of the storage directors and devices are indicated by an eight-bit binary number. The addresses consist of three parts: the storage director address, the address of the controller, and the drive address. Each storage director in the 3880 may have a maximum of 64 device addresses assigned to it. Configurations requiring a maximum of 8, 16, or 32 logical device addresses are subsets of this maximum configuration. Storage directors may be installed to accept 8, 16, 32, or 64 logical device addresses as required by the device configuration. The addresses are installed by the customer engineer through use of switches on the 3880 interface card. Valid device addresses are shown in Figure A-1.

If a channel switch feature is installed on an eight-device configuration, bits 3 and 4 of the address must be the same for all channel inputs. For a 16-drive configuration, bit 3 must be the same for all channel inputs.

*Note: The address switches on the 3880 channel interface card, numbered 1 through 8, correspond to bit positions 0 through 7. Therefore, bits 3 and 4 correspond to switches 4 and 5.*

CONFIGURATION	VALID ADDRESSES (HEXIDECIMAL)			
Up to 8 devices in 1 string (N/A for 3380)	00-07	40-47	80-87	C0-C7
	08-0F	48-4F	88-8F	C8-CF
	10-1F	50-57	90-97	D0-D7
	18-1F	58-5F	98-9F	D8-DF
	20-27	60-67	A0-A7	E0-E7
	28-2F	68-6F	A8-AF	E8-EF
	30-37	70-77	B0-B7	F0-F7
	38-3F	78-7F	B8-BF	F8-FF
Up to 16 devices in 2 strings (1 string for 3380)	00-0F	40-4F	80-8F	C0-CF
	10-1F	50-5F	90-9F	D0-DF
	20-2F	60-6F	A0-AF	E0-EF
	30-3F	70-7F	B0-BF	F0-FF
Up to 32 devices in 3 or more strings (2 strings for 3380)	00-1F	40-5F	80-9F	C0-DF
	20-3F	60-7F	A0-BF	E0-FF
64 Devices*	00-3F	40-7F	80-BF	C0-FF
* See the 3340 and 3344 Addressing section of this manual.				

**Figure A-1. Valid Devices Addresses**



## 3330, 3333, and 3350 Addressing

One to four strings can attach to each storage director in the 3880. If only one string is attached, only 8 drive addresses should be assigned to the storage director; if two strings are attached, 16 drive addresses should be assigned; if three or four strings are attached, 32 drive addresses must be assigned.

The bit assignments for 3330, 3333, and 3350 addressing are as follows.

### Device Address (See Note)

0	1	2	3	4	5	6	7
Storage director address			String controller address		Physical drive address		

## 3340 and 3344 Addressing

For configurations using 3340s only or 3340s and 3344s, the storage director must be assigned 64 drive addresses regardless of the number of drives attached. As shown below, device addressing is modified to handle the multiple logical devices on 3344 drives. Bit 2, the secondary address bit, is used to indicate a second or subsequent logical address on a physical drive.

In a configuration with only 3340s, there are no secondary addresses and bit 2 must be set to zero. Therefore, addresses in ranges X'1C' through X'3F', X'5C' through X'7F', X'9C' through X'BF', and X'DC' through X'FF' cannot be used in 3340-only configurations.

### Device Address (See Note)

0	1	2	3	4	5	6	7
Storage director address		Secondary address bit	String controller address		Drive address		

Figure A-2 on page A-4 shows the valid address ranges for configurations with 3340s only. Figure A-3 on page A-5 shows the valid address ranges for configurations with both 3340s and 3344s.

## 3370 Addressing

One to four strings of 3370s can be attached to each storage director in the 3880. If only one string is attached, only 8 drive addresses should be assigned to the storage director; if two strings are attached, 16 drive addresses should be assigned; if three or four strings are attached, 32 drive addresses must be assigned. Each 3370 has two separate access mechanisms and two logical addresses.

The bit assignments for 3370 addressing are as follows.

### Device Address (See Note)

0	1	2	3	4	5	6	7
Storage director address			String controller address		Drive address		Access mechanism

*Note: The device address bit assignments may differ depending on installed configuration and features. For more specific information, see the appropriate device reference manual listed in the Preface.*

### 3880 Storage Control

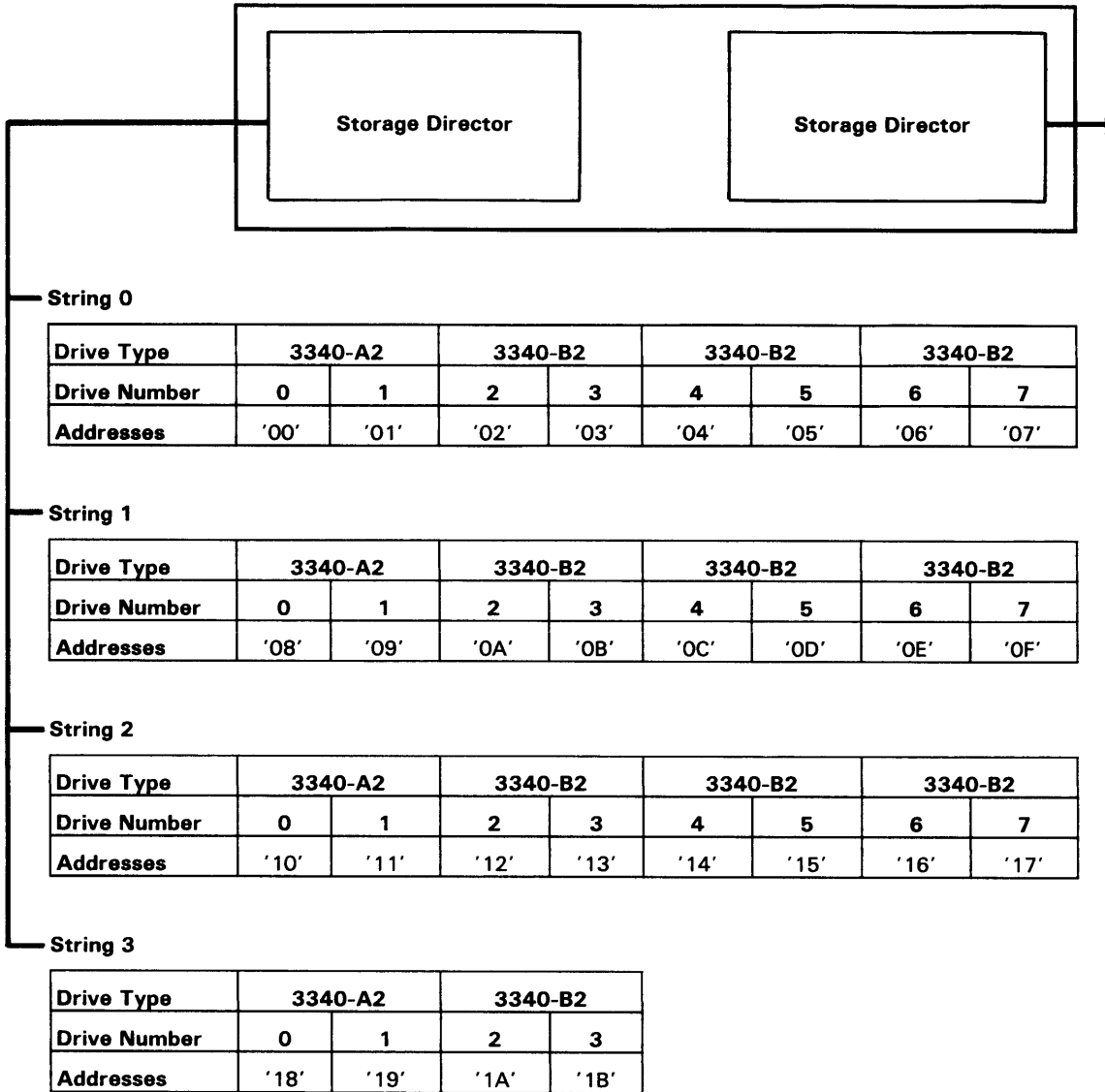

Note: Other valid address ranges for 3340-only configurations are: X'40' - X'5B', X'80' - X'9B', and X'C0' - X'DB'.

Figure A-2. Valid Address Ranges for 3340-Only Configurations

### 3880 Storage Control

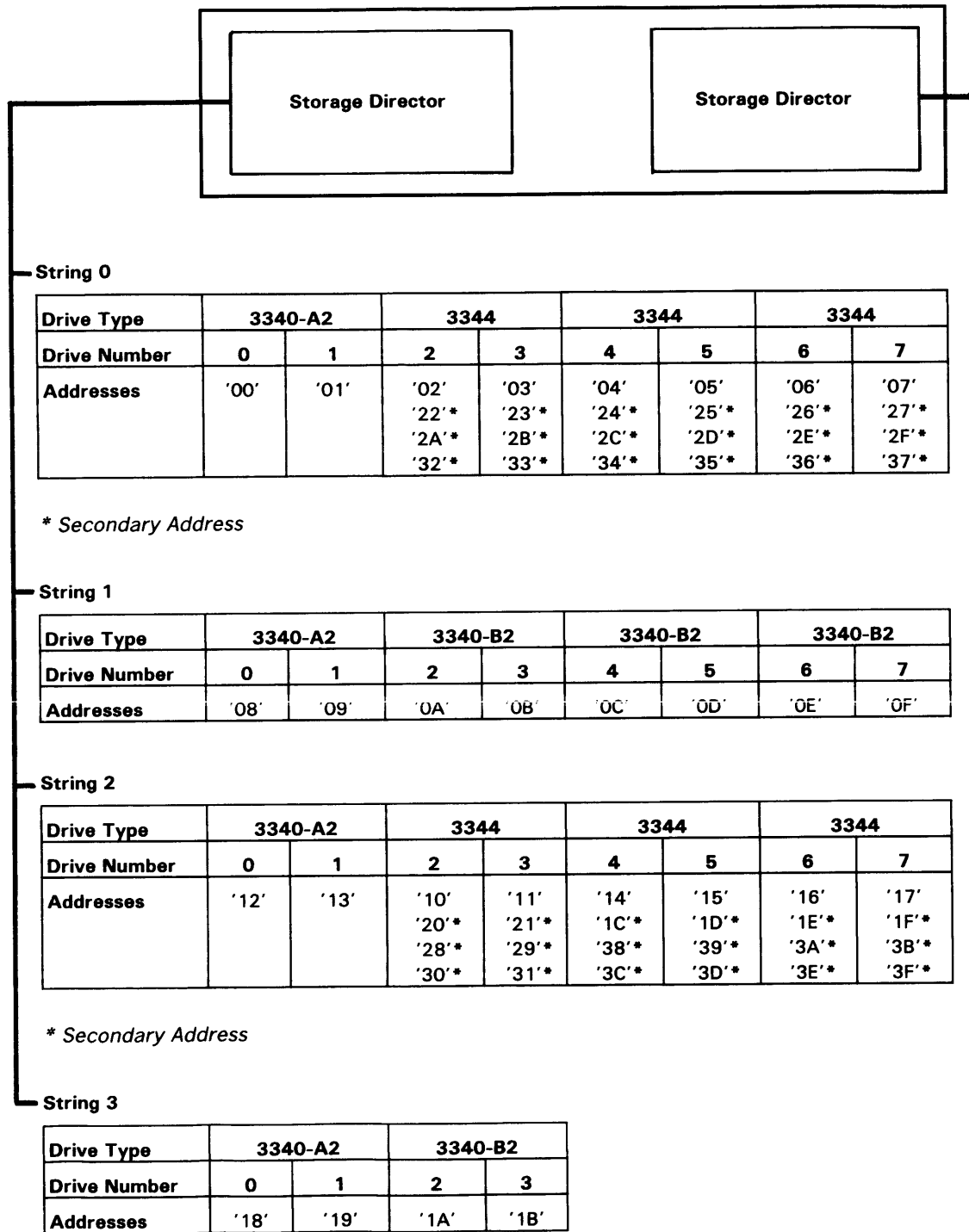

Note: Other valid address ranges for 3340 and 3344 configurations are: X'40' - X'7F', X'80' - X'BF', and X'C0' - X'FF'.

Figure A-3. Valid Address Ranges for Mixed 3340 and 3344 Configurations

## 3375 Addressing

One to four strings of 3375s can be attached to each storage director in the 3880. If only one string is attached, only 8 drive addresses should be assigned to the storage director; if two strings are attached, 16 drive addresses should be assigned, if three or four strings are attached, 32 drive addresses must be assigned. Each 3375 has two separate access mechanisms and two logical addresses.

The bit assignments for 3375 addressing are as follows.

### Device Address

0	1	2	3	4	5	6	7
Storage director address			String controller address		Drive address		Access mechanism

## 3380 Addressing

Up to two 3380 strings headed by Models AA4, A04, and B04 can attach to one storage director in a 3880 Model 2 or to each storage director in a 3880 Model 3. The 3380 Model AA4 must attach to two storage directors. The storage directors can be in the same 3880 Model 3 or in a different 3880 Models 2 or 3.

Up to two 3380 strings headed by Models AA4, AD4 or AE4 DASD can attach to each storage director in a 3880 Model 3 if the 3380 Extended attachment feature is installed. (This consists of the 3380 AD4/AE4 Support Feature #8173 and 3380 EXTENDED Specify code #9208.) See Chapter 1 for a complete explanation of 3380 and DASD configurations.

The string controller address (bit 3) is subject to the following limitations:

- If there is only one string attached to a storage director, bit 3 may be either 0 or 1.
- If there are two strings attached to a storage director, the string controller bit must be 0 for one string and 1 for the other string.
- If there is one string with two string controllers in the A unit (Models AA4, AD4, or AE4), both controllers must have the same address. (Both string controllers cannot be attached to the same storage director.)
- If there are two strings, each with two string controllers in the A unit, the controller bit addresses in one string must be 0s and the controller bit addresses in the other string must be 1s.

If a string with less than 16 access mechanisms is attached to the storage director, the full range of 16 address must still be reserved for that string.

### Device Address

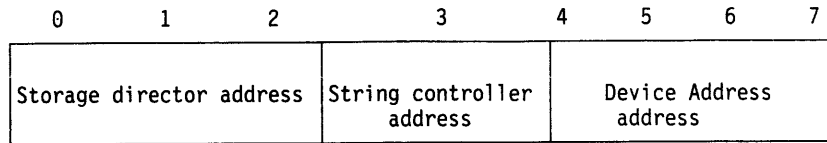

## Physical Identifiers

In complex installations, the 3375 or 3380 strings may be accessed by one or more processors, by multiple channels, and by different storage directors. As a result, a single device can be addressed by the same or many different 3-hexadecimal digit unit addresses.

To overcome this identification problem, the customer and customer engineer now assign a unique physical identifier (ID) to each storage director and controller. These identifiers, unlike the unit address, are unique within the installation. Physical IDs are illustrated in Figure A-4 on page A-8.

The physical identifiers are set with switches at installation and are in addition to I/O (unit) addresses that also are set by the customer engineer at installation. Spaces are provided on the controller operator panels to affix physical ID labels.

Physical IDs are included in the 24 bytes of sense information sent in response to a Sense channel command. They also are included in system messages to the operator and in EREP reports.

Besides being used to identify a failing storage director/controller path, the physical ID may be helpful in configuration management. For example, it may be used to communicate the identification of a particular 3375 or 3380 string that is to be disabled with a switch on the operator panel.

### Storage Director Identifiers

The 3880 storage director is assigned a 1-byte (2-hexadecimal characters) physical identifier (ID).

The storage director IDs must be assigned in pairs in each 3880 Storage Control. The two numbers must be consecutive, with the even number having the smaller value. For example: X'02' and X'03', X'30' and X'31'C are valid pairs; X'05' and X'06', X'23' and X'24' are not valid pairs because they begin with odd numbers. Numbering should not begin with X'00' and X'01'.

## Device Identifiers

In 3375s or 3380s, only one physical identifier (ID) is needed; but in models with two string controllers, two physical IDs are assigned, one for each controller. As with the storage directors, the two numbers must be consecutive, with the even numbers having the smaller value. Physical IDs for a controller address of 0 must be between X'02' and X'7F'; those for a controller address of 1 must be between X'80' and X'FD'.

Besides the assigned storage director and string controller physical IDs, the device also has a physical ID. The device physical ID is the same as the device address. The first of the two hexadecimal digits of the physical ID is always zero.

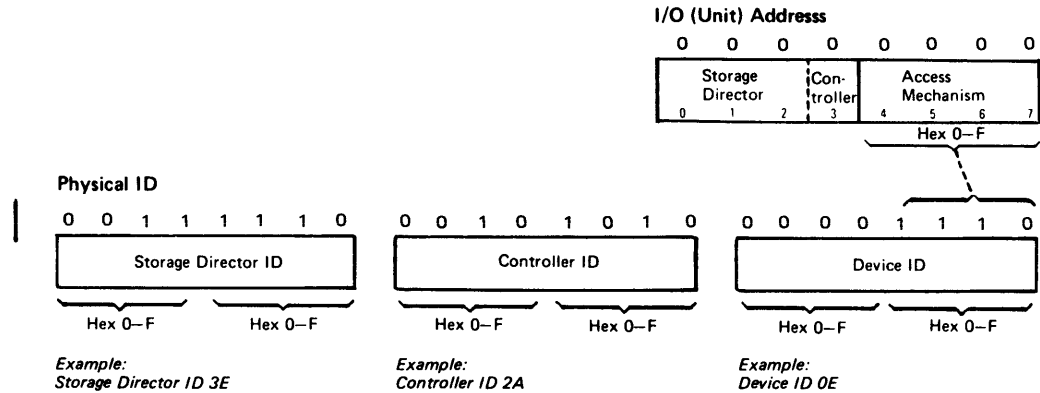

Figure A-4. Physical ID Assignment

**IBM 3880 Storage Control Description  
Models 1, 2, 3, and 4**

**READER'S  
COMMENT  
FORM**

**Order No. GA26-1661-9**

This manual is part of a library that serves as a reference source for systems analysts, programmers, and operators of IBM systems. You may use this form to communicate your comments about this publication, its organization, or subject matter with the understanding that IBM may use or distribute whatever information you supply in any way it believes appropriate without incurring any obligation to you. Your comments will be sent to the author's department for whatever review and action, if any, are deemed appropriate.

*Note: Copies of IBM publications are not stocked at the location to which this form is addressed. Please direct any requests for copies of publications, or for assistance in using your IBM system, to your IBM representative or to the IBM branch office serving your locality.*

Possible topics for comment are:

Clarity    Accuracy    Completeness    Organization    Coding    Retrieval    Legibility

If you wish a reply, give your name, company, mailing address, and date:

---

---

---

---

What is your occupation? \_\_\_\_\_

Number of latest Newsletter associated with this publication: \_\_\_\_\_

Thank you for your cooperation. No postage stamp necessary if mailed in the U.S.A. (Elsewhere, an IBM office or representative will be happy to forward your comments or you may mail them directly to the address in the Edition Notice on the back of the front cover or title page.)



# Reader's Comment Form

Cut or Fold Along Line

Fold and Tape

Please Do Not Staple

Fold and Tape

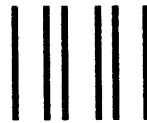

NO POSTAGE  
NECESSARY  
IF MAILED  
IN THE  
UNITED STATES

**BUSINESS REPLY MAIL**  
FIRST CLASS    PERMIT NO. 40    ARMONK, N.Y.

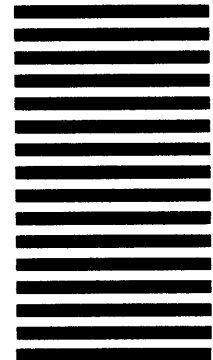

POSTAGE WILL BE PAID BY THE ADDRESSEE

International Business Machines Corporation  
Department 61C  
P.O. Box 27155  
Tucson, AZ, USA 85744

Fold and Tape

Please Do Not Staple

Fold and Tape



# Index

## A

### address

- general 2-11
- physical A-7
- storage director A-7
- 3330, 3333, 3350 A-2
- 3340/3344 A-2
- 3370 A-3
- 3375 A-6
- 3380 A-6

alternate controller selected (3350 sense bit) 9-5

## B

- block multiplexer feature 1-6, 5-16
- block size exception (3370 sense bit) 7-3
- bus out parity (sense bit)
  - 3330 8-2
  - 3340 10-2
  - 3350 9-2
  - 3370 7-2
  - 3375 11-2
  - 3380 12-2

## C

- channel check 1 12-21
- channel command word
  - description 2-3
  - format 2-3, 2-5
- channel programs 4-95
- channel selection 5-13
- channel switching 5-13
- check data error (3370 sense bit) 7-4
- clock stopped check 1 12-21
- command reject (sense bit)
  - 3330 8-1
  - 3340/3344 10-1
  - 3350 9-1
  - 3370 7-1
  - 3375 11-1
  - 3380 12-1
- command retry feature 1-6, 5-13
- controller check 2 and device check 1 12-41
- correctable (sense bit)
  - 3330 8-5
  - 3340/3344 10-4
  - 3350 9-5
  - 3370 7-4

- 3375 11-5
- 3380 12-5

correctable data check 12-29

## D

- data check (sense bit)
  - 3330 8-2
  - 3340/3344 10-2
  - 3350 9-2
  - 3370 7-2
  - 3375 11-2
  - 3380 12-2
- Define Extent
  - CKD command 4-23
  - fixed block command 3-3
- device check 1 and controller check 2 12-41
- device connection control checks 12-36
- Device Release
  - CKD command 4-68
  - fixed block command 3-22
- Device Reserve
  - CKD command 4-65
  - fixed block command 3-21
- Diagnostic Control
  - CDK command 4-91
  - fixed block command 3-25
  - subcommands
    - Displace ID 3-30
    - Format ID 3-31
    - Read ID 3-32
    - Space ID and Read Data 3-27
    - Trace Dump 3-26
- Diagnostic Load, CKD command 4-89
- Diagnostic Sense/Read, CKD command 3-31
- Diagnostic Sense, CKD command 4-88
- Diagnostic Write, CKD command 4-90

## E

- eight-channel switch feature 1-5, 5-13
- end of cylinder (sense bit)
  - 3330 8-3
  - 3340/3344 10-3
  - 3350 9-3
  - 3375 11-3
  - 3380 12-3
- end of file feature 1-6
- environmental data present (sense bit)
  - 3330 8-5
  - 3340/3344 10-5
  - 3350 9-5

3370 7-4  
 3375 11-5  
 3380 12-5  
 equipment check (sense bit)  
   3330 8-2  
   3340/3344 10-2  
   3350 9-2  
   3370 7-2  
   3375 11-2  
   3380 12-2  
 Erase, CKD command 4-78  
 error condition tables  
   3330/3350 9-25  
   3340/3344 10-24  
   3370 7-22  
   3375 11-26  
   3380 12-44  
 error recovery procedures 6-1  
 error, overrun, and usage statistics 12-31  
 examples of channel programs 4-95

## F

Feature 3005 1-9  
 features, standard and special  
   block multiplexer 1-6, 5-16  
   command retry 1-6, 5-13  
   eight-channel switch 1-5, 5-13  
   end of file 1-6  
   Feature 3005 1-9  
   multitrack 5-1  
   multitrack operation 1-7  
   record overflow 1-6, 5-3  
   remote switch 1-5, 5-14  
   rotational position sensing 5-9  
   speed matching buffer for 3375 1-6, 5-16  
   speed matching buffer for 3380 1-5, 5-17  
   two channel switch pair 1-5  
   two channel switch pair, additional 1-5  
   two-channel switch 1-5, 5-13  
   two-channel switch pair 5-13  
   two-channel switch pair, additional 5-13  
   3330, 3333, and 3350 attachment feature 1-7  
   3340 and 3344 attachment feature 1-7  
   3370 attachment feature 1-8  
   3375 attachment feature 1-8  
   3380 attachment feature 1-8  
   3380 extended attachment feature 1-9  
 file protected (sense bit)  
   3330 8-4  
   3340/3344 10-3  
   3350 9-4  
   3370 7-3  
   3375 11-4  
   3380 12-4  
 format identifier 12-10

## I

imprecise ending (sense bit)  
   3375 11-5  
   3380 12-6  
 intent violation (sense bit)  
   3375 11-5  
   3380 12-5  
 intervention required (sense bit)  
   3330 8-1  
   3340/3344 10-1  
   3350 9-1  
   3370 7-1  
   3375 11-2  
   3380 12-2  
 invalid track format (sense bit)  
   3330 8-3  
   3340/3344 10-3  
   3350 9-3  
   3375 11-3  
   3380 12-3

## L

Locate Record, CKD command 4-26  
 Locate, fixed block command 3-6

## M

message to operator (sense bit)  
   3330 8-3  
   3340/3344 10-3  
   3350 9-3  
   3370 7-3  
   3375 11-3  
   3380 12-4  
 multitrack feature 1-7, 5-1

## N

no record found (sense bit)  
   3330 8-3  
   3340/3344 10-3  
   3350 9-3  
   3375 11-4  
   3380 12-4  
 No-Operation (No-Op)  
   CKD command 4-3  
   fixed block command 3-2

## O

- operation incomplete (sense bit)
  - 3330 8-4
  - 3340/3344 10-4
  - 3350 9-4
  - 3370 7-3
- Operator Panel
  - Subsystem Power 13-1
  - System Configuration 13-2
  - Unit Emergency 13-2
- overrun (sense bit)
  - 3330 8-2
  - 3340/3344 10-2
  - 3350 9-2
  - 3375 11-2
  - 3380 12-2
- overrun, error, and usage statistics 12-31

## P

- permanent error (sense bit)
  - 3330 8-3
  - 3340/3344 10-3
  - 3350 9-3
  - 3375 11-3
  - 3380 12-3

## R

- Read and Reset Buffered Log
  - CKD command 4-64
  - fixed block command 3-18
- Read command
  - CKD command 4-53
  - example program
    - CKD 4-104
    - fixed block 3-37
    - SMB 4-116
  - fixed block command 3-10
- Read Count, CKD command 4-49
- Read Data, CKD command 4-51
- Read Device Characteristics
  - CKD command 4-69
  - fixed block command 3-19
- Read Home Address, CKD command 4-47
  - Read Special Home Address, CKD command 4-48
- Read IPL
  - CKD command 4-56
  - fixed block command 3-12
- Read Key and Data, CKD command 4-52
- Read Multiple Count, Key, and Data command 4-54

- Read Record Zero, CKD command 4-50
- Read Sector, CKD command 4-57
- Recalibrate, CKD command 4-4
- record overflow feature 1-6, 5-3
- remote switch feature 1-5, 5-14
- Restore, CKD command 4-18
- rotational position sensing feature 5-9

## S

- sample channel programs 4-95
- Search Home Address Equal, CKD command 4-33
- Search Identifier Equal or High, CKD command 4-39
- Search Identifier Equal, CKD command 4-35
- Search Identifier High, CKD command 4-37
- Search Key Equal or High, CKD command 4-45
- Search Key Equal, CKD command 4-41
- Search Key High, CKD command 4-43
- Seek Cylinder, CKD command 4-7
- Seek Head, CKD command 4-9
- Seek, CKD command 4-5
- Sense
  - CKD command 4-62
  - fixed block command 3-16
- sense bytes
  - 3330 8-1
  - 3340/3344 10-1
  - 3350 9-1
  - 3370 7-1
  - 3375 11-1
  - 3380 12-1
- sense bytes, 3330
  - format 0 8-9
  - format 1 8-10
  - format 2 8-14
  - format 3 (hardware detected) 8-16
  - format 3 (microcode detected) 8-17
  - format 4 8-18
  - format 5 8-20
  - format 6 8-22
- sense bytes, 3340 and 3344
  - format 0 10-8
  - format 1 10-10
  - format 2 10-15
  - format 3 (hardware detected) 10-16
  - format 3 (microcode detected) 10-17
  - format 4 10-18
  - format 5 10-20
  - format 6 10-22
- sense bytes, 3350
  - format 0 9-9
  - format 1 9-10
  - format 2 9-15
  - format 3 (hardware detected) 9-17
  - format 3 (microcode detected) 9-18
  - format 4 9-19

- format 5 9-21
- format 6 9-23
- sense bytes, 3370
  - format 0 7-7
  - format 1 7-9
  - format 2 7-14
  - format 3 (hardware detected) 7-15
  - format 3 (microcode detected) 7-16
  - format 4 7-17
  - format 5 7-19
  - format 6 7-20
- sense bytes, 3375
  - format 0 11-9
  - format 1 11-11
  - format 2 11-16
  - format 3 (hardware detected) 11-18
  - format 3 (microcode detected) 11-19
  - format 4 11-20
  - format 5 11-22
  - format 6 11-24
- sense bytes, 3380
  - format 0 12-11
  - format 1 12-13
  - format 2 12-19, 12-20
  - format 3 (channel check 1) 12-21
  - format 3 (clock stopped check 1) 12-21
  - format 3 (hardware detected) 12-21
  - format 3 (microcode detected) 12-22
  - format 4 12-23, 12-26
  - format 5 12-27, 12-29
  - format 6 12-30, 12-31
  - format 7 12-32, 12-36
  - format 8 12-37, 12-41
  - Format 9 12-42, 12-43
- Sense Identification
  - CKD command 4-58
  - fixed block command 3-17
- Sense Path Group Identifier, CKD command 4-60
- Set File Mask, CKD command 4-13
- Set Path Group Identifier, CKD command 4-20
- Set Sector, CKD command
  - description and requirements 4-16
  - example 5-11
  - sector calculation 5-9
- Space Count, CKD command 4-11
- speed matching buffer
  - 3375 5-16
  - 3380 5-17
- speed matching buffer for 3375 feature 1-6, 5-16
- speed matching buffer for 3380 feature 5-17
- speed matching buffer for 3380, feature 1-5
- status information 2-3
- storage director control checks 12-21
- storage director equipment check 12-20

- Suspend Multipath Reconnection, CKD command 4-19

## T

- two channel switch pair feature 1-5
- two-channel switch feature 1-5, 5-13
- two-channel switch pair feature 5-13
- two-channel switch pair, additional feature 1-5, 5-13

## U

- Unconditional Reserve
  - CKD command 4-66
  - fixed block command 3-23
- uncorrectable data check 12-26
- usage, overrun, and error statistics 12-31

## W

- Write Count, Key, and Data, CKD command 4-79
- Write Data, CKD command 4-83
- Write Home Address, CKD command 4-72
- write inhibit (sense bit)
  - 3330 8-4
  - 334/3344 10-4
  - 3350 9-4
  - 3370 7-3
- Write Key and Data, CKD command 4-84
- Write Record Zero, CKD command 4-76
- Write Special Count, Key, and Data, CKD command 4-81
- Write Special Home Address, CKD command 4-74
- Write, fixed block command 3-13

## Numerics

- 3330, 3333, and 3350 attachment feature 1-7
- 3340 and 3344 attachment feature 1-7
- 3370 attachment feature 1-8
- 3375 attachment feature 1-8
- 3380 AJ4/AK4 DASD Attachment (Feature 3005) 1-9
- 3380 attachment feature 1-8
- 3380 extended attachment feature 1-9